

**Proceedings of the 30<sup>th</sup> Conference of the  
International Group for the  
Psychology of Mathematics Education**

**charles university.cz**



**Prague, Czech Republic  
July 16-21, 2006**

## **Volume 5**

**Research Reports**

**Sac - Zaz**

**Editors: Jarmila Novotná  
Hana Moraová, Magdalena Krátká, Naďa Stehlíková**

**Charles University in Prague  
Faculty of Education**

*Proceedings of the 30<sup>th</sup> Conference of the  
International Group for the Psychology of Mathematics Education*

*Volume 5*

**Editors**

Jarmila Novotná  
Hana Moraová  
Magdalena Krátká  
Nad'a Stehlíková

Charles University in Prague  
Faculty of Education  
Czech Republic

The Proceedings are also available on CD-ROM

Copyright © 2006 left to the authors  
All rights reserved

ISSN 0771-100X

Logo: Ivan Špirk  
Cover Design: Jarmila Novotná & Ivan Špirk  
Printing: Atelier Guimaec, s.r.o

# TABLE OF CONTENTS

## VOLUME 5

### Research Reports

Sacristán, Ana Isabel & Kieran, Carolyn	5-1
<i>Bryan's story: Classroom miscommunication about general symbolic notation and the emergence of a conjecture during a CAS-based algebra activity</i>	
Sáenz-Ludlow, Adalira	5-9
<i>A teacher's method to introduce story-problems: Student-generated problems</i>	
San Diego, Jonathan P. & Aczel, James & Hodgson, Barbara & Scanlon, Eileen	5-17
<i>"There's more than meets the eye": Analysing verbal protocols, gazes and sketches on external mathematical representations</i>	
Sánchez, Ernesto & Martínez, Miguel Mercado	5-25
<i>Notions of variability in chance settings</i>	
Sánchez, Victoria & García, Mercedes & Escudero, Isabel	5-33
<i>Elementary preservice teacher learning levels</i>	
Santos, Dora & Ursini, Sonia & Ramirez, Martha Patricia & Sanchez, Gabriel	5-41
<i>Mathematics achievement: Sex differences vs. gender differences</i>	
Santos, Leonor & Gomes, Anabela	5-49
<i>Self assessment and appropriation of assessment criteria</i>	
Saundry, Carole & Nicol, Cynthia	5-57
<i>Drawing as problem-solving: Young children's mathematical reasoning through pictures</i>	
Schwarz, Baruch & Hershkowitz, Rina & Azmon, Shirly	5-65
<i>The role of the teacher in turning claims to arguments</i>	
Seago, Nanette & Goldsmith, Lynn	5-73
<i>Learning mathematics for teaching</i>	

Sekiguchi, Yasuhiro	5-81
<i>Coherence of mathematics lessons in Japanese eighth-grade classrooms</i>	
Serow, Penelope	5-89
<i>Triangle property relationships: making the connections</i>	
Setati, Mamokgethi	5-97
<i>Access to mathematics versus access to the language of power</i>	
Shiakalli, Myria & Gagatsis, Athanasios	5-105
<i>Compartmentalization of representation in tasks related to addition and subtraction using the number line</i>	
Siemon, Dianne & Izard, John & Breed, Margarita & Virgona, Jo	5-113
<i>The derivation of a learning assessment framework for multiplicative thinking</i>	
Sierpiska, Anna	5-121
<i>Sources of students' frustration in bridging mathematics courses</i>	
Sinclair, Nathalie & Crespo, Sandra	5-129
<i>What makes a good problem? An aesthetic lens</i>	
Son, Hong-chan & Lew, Hee-chan	5-137
<i>Discovering a rule and its mathematical justification in modeling activities using spreadsheet</i>	
Son, Ji-Won	5-145
<i>Investigating preservice teachers' understanding and strategies on a student's errors of reflective symmetry</i>	
Spinillo, Alina Galvão & Lautert, Sintria Labres	5-153
<i>Exploring the role played by the remainder in the solution of division problems</i>	
Steinle, Vicki & Pierce, Robyn	5-161
<i>Incomplete or incorrect understanding of decimals: An important deficit for student nurses</i>	
Steinthorsdottir, Olof Bjorg	5-169
<i>Proportional reasoning: Variable influencing the problems difficulty level and one's use of problem solving strategies</i>	

Stephanou, Lambros, & Pitta-Pantazi, Demetra <i>The impact of the intuitive rule “if A then B, if not A then not B” in perimeter and area tasks</i>	5-177
Stewart, Sepideh & Thomas, Michael O. J. <i>Process-object difficulties in linear algebra: Eigenvalues and eigenvectors</i>	5-185
Stoyanova Kennedy, Nadia <i>Conceptual change as dialectical transformation</i>	5-193
Stylianides, Andreas J. & Stylianides, Gabriel J. <i>Content knowledge for mathematics teaching: The case of reasoning and proving</i>	5-201
Stylianides, Gabriel J. & Stylianides, Andreas J. <i>“Making proof central to pre-high school mathematics is an appropriate instructional goal”: Provable, refutable, or undecidable proposition?</i>	5-209
Swanson, Dalene M. <i>Power and poverty – whose, where, and why?: School mathematics, context and the social construction of “disadvantage”</i>	5-217
Sztajn, Paola <i>Documenting learning in school-based mathematics communities of teachers</i>	5-225
Tabach, Michal <i>Research and Teaching – Can one person do both? A case study</i>	5-233
Talmon, Varda & Yerushalmy, Michal <i>Computer “knowledge” and student’s images of figures: The case of dragging</i>	5-241
Tan, Hazel & Forgasz, Helen J. <i>Graphics calculators for mathematics learning in Singapore and Victoria (Australia): Teachers’ views</i>	5-249
Tatsis, Konstantinos & Rowland, Tim <i>Vague language in Greek and English mathematical talk: A variation study in face-work</i>	5-257

Thomas, Michael O. J. <i>Teachers using computers in mathematics: A longitudinal study</i>	5-265
Thornton, Steve & Reynolds, Noemi <i>Analysing classroom interactions using critical discourse analysis</i>	5-273
Topçu, Tahsin & Kertil, Mahmut & Akkoç, Hatice & Yılmaz, Kamil & Önder, Osman <i>Pre-service and in-service mathematics teachers' concept images of radian</i>	5-281
Torbeyns, Joke & Vanderveken, Lien & Verschaffel, Lieven & Ghesquière, Pol <i>Adaptive expertise in the number domain 20-100</i>	5-289
Triantafillou, Chrissavgi & Potari, Despina <i>Mathematical activity in a technological workplace: Results from an ethnographic study</i>	5-297
Van Dooren, Wim & De Bock, Dirk & Evers, Marleen & Verschaffel, Lieven <i>Pupils' over-use of proportionality on missing-value problems: How numbers may change solutions</i>	5-305
Vargas, Verónica & Guzmán, José <i>Arithmetical procedures in the solution of a problem involving velocity</i>	5-313
Verikios, Petros & Farmaki, Vassiliki <i>Introducing algebraic thinking to 13 year-old students: The case of the inequality</i>	5-321
Viholainen, Antti <i>Why is a discontinuous function differentiable?</i>	5-329
Villarreal, Mónica & Esteley, Cristina & Alagia, Humberto <i>Overgeneralization of linear models: Presence and characteristics among university students</i>	5-337
Vos, Pauline & Devesse, Tiago G. & Rassul, Assane <i>Educational design research in Mozambique: Starting mathematics from authentic resources</i>	5-345

Walls, Fiona	5-353
<i>“The big test”: A school community experiences standardized mathematics assessment</i>	
Walshaw, Margaret & Anthony, Glenda	5-361
<i>Numeracy reform in New Zealand: Factors that influence classroom enactment</i>	
Wang, Ning & Cai, Jinfan	5-369
<i>An investigation of factors influencing teachers’ scoring student responses to mathematics constructed-response assessment tasks</i>	
Warren, Elizabeth	5-377
<i>Teacher actions that assist young students write generalizations in words and in symbols</i>	
Widjaja, Wanty & Stacey, Kaye	5-385
<i>Promoting pre-service teachers’ understanding of decimal notation and its teaching</i>	
Williams, Gaye	5-393
<i>Impetus to explore: Approaching operational deficiency optimistically</i>	
Wu, Chao-Jung & Wong, Wing-Kwong & Cheng, Ying-Hao & Lien, Yunn-Wen	5-401
<i>Generating and evaluating geometry conjectures with self-directed experiments</i>	
Wu, Der-bang & Ma, Hsiu-lan	5-409
<i>The distributions of van Hiele levels of geometric thinking among 1<sup>st</sup> through 6<sup>th</sup> graders</i>	
Wu, Su-Chiao & Chang, Yu Liang	5-417
<i>Elementary teacher education and teacher efficacy toward mathematics and science</i>	
Xistouri, Xenia & Pitta-Pantazi, Demetra	5-425
<i>Spatial rotation and perspective taking abilities in relation to performance in reflective symmetry tasks</i>	
Yates, Shirley M.	5-433
<i>Elementary teachers’ mathematics beliefs and teaching practices after a curriculum reform</i>	

Yevdokimov, Oleksiy	5-441
<i>Inquiry activities in a classroom: Extra-logical processes of illumination vs logical process of deductive and inductive reasoning. A case study</i>	
Yoshida, Kaori	5-449
<i>Developments of a child's fraction concepts with the help of psychological tools: A Vygotsky's cultural-historical perspective</i>	
Zaslavsky, Orit & Harel, Guershon & Manaster, Alfred	5-457
<i>A teacher's treatment of examples as reflection of her knowledge-base</i>	
Zazkis, Rina & Chernoff, Egan	5-465
<i>Cognitive conflict and its resolution via pivotal/bridging example</i>	



# **BRYAN’S STORY: CLASSROOM MISCOMMUNICATION ABOUT GENERAL SYMBOLIC NOTATION AND THE EMERGENCE OF A CONJECTURE DURING A CAS-BASED ALGEBRA ACTIVITY**

Ana Isabel Sacristán

&

Carolyn Kieran

Center for Advanced Studies & Research  
(Cinvestav), Mexico

Université du Québec à Montréal,  
Montréal, Canada

*We describe a high-school student’s difficulties in understanding the notation for a general polynomial:  $x^{n-1} + x^{n-2} + \dots + x + 1$  during a CAS-based activity to develop a general factorization for  $x^n - 1$ . We illustrate how he attributes a meaning to the ellipsis symbol related to his experience of “terms cancelling out” rather than the taken-for-granted meaning of an undefined continuing process. We show his associated difficulties in making sense of the sequence of decreasing exponents. Finally, emerging from his misunderstandings, we describe his motivation to find a general formula for  $x^n + 1$ , testing his conjectures using the CAS.*

In this paper we present the story of a 15-year-old high-school student, Bryan, working on a CAS-based algebra activity: we show some of the issues that arose in terms of language and communication difficulties, and how he used the tool in his quest for meaning and to generate and test conjectures. We are interested in narrating Bryan’s story and the evolution of his thinking process, for two reasons. First, it highlights possible language and communication problems in a classroom: the difficulties that students may face when encountering, for the first time, conventional symbols (that can be taken for granted by teachers) and general algebraic notations, and the “cross-talk” that can happen between teachers and students. There are conventions which we take for granted and we do not realize might be a problem for students. In this particular case, general expressions of polynomials using the ellipsis (‘...’) notation were a source of difficulties. Language and communication in the mathematics classroom and the use of symbols have been extensively studied (e.g., Pimm, 1987, who does address the issue of symbols from common writing systems that are used in mathematics with perhaps different conventional meaning), but nowhere in the current research literature could we find a discussion or case related to the ellipsis notation. Second, the story narrated here, is one that took place in a CAS-based activity using TI-92 Plus calculators. What is thus also interesting is how, in face of his confusions, the student was motivated to make use of the tool and test a conjecture that arose from his misunderstanding.

## **THE STUDY**

This report emanates from an ongoing research study whose central objective is the shedding of further light on the co-emergence of technique and theory (e.g., Artigue, 2002) within the CAS-based symbol manipulation activity of secondary school

---

2006. In Novotná, J., Moraová, H., Krátká, M. & Stehlíková, N. (Eds.). *Proceedings 30<sup>th</sup> Conference of the International Group for the Psychology of Mathematics Education*, Vol. 5, pp. 1-8. Prague: PME.

5 - 1

algebra students. Several sets of activities that aimed at supporting this co-emergence were developed by members of the research team<sup>1</sup>. Six 10<sup>th</sup> grade classes were involved in the study. All of their classroom-based CAS activity was videotaped; and digital records were made of all the student worksheets. The results presented here focus on a selected aspect of the analysis from one of the activity sets (see Kieran & Saldanha, in press; see, as well, a companion research report relating to the same study, but presenting a different component of the analysis).

### The Factoring Activity

The factoring activity (inspired by an example developed by Mounier & Aldon, 1996, and described by Lagrange, 2000) had as objectives to establish connections between notions that students already knew regarding the difference of squares and the sum and difference of cubes:

$$x^2 - 1 = (x - 1)(x + 1); x^3 - 1 = (x - 1)(x^2 + x + 1); x^3 + 1 = (x + 1)(x^2 - x + 1),$$

and the general factorization for  $x^n - 1$  given by:

$$x^n - 1 = (x - 1)(x^{n-1} + x^{n-2} + \dots + x^2 + x + 1).$$

We designed a worksheet with a sequence of tasks for this activity, alternating with reflection questions and whole-class discussion periods. In many of those tasks, students were asked to factorize particular cases of the type  $x^n - 1$  first using paper-and-pencil, then the calculator, and then to show how the paper-and-pencil and the CAS results could be reconciled.

### BRYAN'S STORY

During the factoring activity, the students had been working on factoring the cases:  $x^2 - 1$ ;  $x^3 - 1$ ;  $x^4 - 1$ . It was intended that they begin to see a general pattern that they might not have noticed when initially learning to factor a difference of squares and a difference of cubes. This was followed by a question (see Figure 1), a class discussion, and predicting the factorization of  $x^5 - 1$ . During the class discussion, the teacher showed on the whiteboard that when factoring each of the above expressions, the product of the factors would make all the middle terms “cancel out”: for example, for  $x^2 - 1$ :  $(x - 1)(x + 1) = x^2 + \cancel{x} - \cancel{x} - 1$ . Also in this discussion, when the teacher asked who could say something about all those expressions, it was Bryan who remarked that  $x - 1$  was a factor in all of them. Bryan was a student who participated and contributed very often in the class activities (at least in the CAS-based activities we observed) and always asked the teacher or classmates when he did not understand something. But he was also an attention-seeker; so his classmates and teacher didn't always take him seriously, despite sincere doubts and smart conjectures.

---

<sup>1</sup> The members of the research team who are involved in the Algebra in Partnership with Technology (APT) project include: André Boileau, José Guzman, Fernando Hitt, Carolyn Kieran, Luis Saldanha (now at Portland State University), and Denis Tanguay. Paul Drijvers collaborated with the team as a Visiting Researcher during the Autumn 2005 session; as did Ana Isabel Sacristán during a part of the Spring 2005 session.

2. (d) How do you explain the fact that the following products result in a binomial: two binomials, a binomial with a trinomial, and a binomial with a quadrinomial?

Because the middle terms always cancel out in this case which creates binomials

Figure 1: Bryan's answer to question 2d – “because the middle terms always cancel out in this case which creates binomials”.

### Towards a Generalization and the Introduction of New Symbols: The Problem of the Ellipsis

The question that followed was: “Explain why the product  $(x-1)(x^{15} + x^{14} + x^{13} + \dots + x^2 + x + 1)$  gives the result  $x^{16} - 1$ ?” Here, Bryan's difficulties began. He exclaimed: “*The next [question] does not make any sense.*” As we will see, Bryan did not understand the meaning of the ellipsis (“...”). The teacher, however, did not pay attention to what his confusion could be; he simply explained what the task question asked: “*The middle terms cancel out, like we said before, like the thing we did before. So the ‘minus one’ takes care of all the terms apart from the first one and the last one. So, we’re left with  $x^{16} - 1$ .*” So Bryan wrote that as his answer (see Figure 2). A similar question was given for  $x^{135} - 1$ , and the reply was the same. As we will see, this repeated emphasis on the idea that “the middle terms cancel out” would have repercussions on the meanings created.

2. (f) Explain why the product  $(x-1)(x^{15} + x^{14} + x^{13} + \dots + x^2 + x + 1)$  gives the result  $x^{16} - 1$ ?

The middle terms all cancel out

Figure 2: Bryan's answer to question 2f – “The middle terms all cancel out”.

During the class discussion period that followed, the teacher introduced the general expression for  $x^n - 1$  (earlier than was expected in the design of the activity). With the input of some students, he wrote on the whiteboard:  $(x^n - 1) = (x - 1)(x^{n-1} + x^{n-2} \dots + x + 1)$ . However, several students were confused by the notation and asked what  $n$  meant; the teacher explained: “*n means any integer, any positive integer.*” While writing the expression, the teacher read for the ellipsis “plus ‘dot dot dot’”. Bryan expressed his confusion on the meaning of this symbol:

Bryan: What are the dots?

Teacher (not really answering Bryan): So it goes all the way to one [pointing to the 1 in the expression:  $x^{n-1} + x^{n-2} \dots + x + 1$ ] Is that clear? We all see that?

Bryan: No, I do not understand. Why the dot, dot, dot?

Teacher (not really answering Bryan): It is the same way we did for  $x$  to the 135 [for  $x^{135} - 1$ ]: you know that the middle terms are going to cancel out. [...]

Bryan: What are the dots? Wouldn't it all be the same if it's  $x^{n-1}$  plus 1 [ $x^{n-1} + 1$ ] except we have that middle term thing; wouldn't that be the same thing?... If the first bracket is like  $(x-1)$ , but the second bracket, instead of putting that middle term thing in there, you just do  $x^{n-1}$  plus 1 [ $x^{n-1} + 1$ ].

[The teacher wrote out what Bryan said:  $(x-1)(x^{n-1} + 1)$ , then showed that the two expressions were not the same; but Bryan was not satisfied.]

Teacher: So those don't cancel, do they?

Bryan: They should, though!

All the emphasis in previous tasks on cases where the middle terms cancelled out, seems to have led Bryan to give this meaning – that the middle part cancels out -- to the ellipsis symbol ('...'), which he did not understand. Thus the teacher and Bryan gave different meanings to the term 'cancel' and to the ellipsis, which, as we will show in the next sections, caused problems in the understanding of the algebraic notation. As Arzarello (1998, p. 259) points out:

One of the main problems in teaching algebra (and most of mathematics) is a communication problem. The relationship between signs and their mathematical meanings may be confused for many students who attach only formal and procedural features to the former but who use the same words as their teachers, albeit with different meanings, for representing the situation.

The teacher took for granted that the ellipsis symbol would be understood. In the history of mathematics, Cajori (1928/9, vol. II, pp. 59-60) reveals the following with respect to the use of general notation and the ellipsis symbol:

L'Abbé de Gua [1741] writes a finite expression, marking the terms omitted, with [four] dots and also with “&c.”: “3,4,5....&c  $n-m+2$ ” [with a bar over the  $n-m+2$ ], the commas indicating here multiplication. F. Nicole [1743] writes a procession of factors, using dots, but omitting the “&c.”. [text deleted] C.F. Hindenburg [1779] uses dots between, say, the fourth term and the  $n$ th term, the + or the – sign being prefixed to the last or  $n$ th term of the polynomial. [text deleted] E.G. Fischer [1794] writes a finite expression  $y = ax + bx^2 + cx^3 + \dots + px^r$  and, in the case of an infinite series of positive terms, he ends with “+etc.”.

Cajori also adds that, “Descartes [1637] wrote  $a^3, x^4$ ; the extension of this to general exponents  $a^n$  was easy” (Cajori, 1928/9, Vol. 1, p. 360). However, it is not clear when general polynomial notation and the use of the ellipsis symbol became widely accepted or even standardized, for Euler (1797, Vol. II, p. 31) in his *Elements of Algebra* was still using notation, for general expressions, such as “ $a + bx + cy + dxx + exy + fx^3 + gxxy + hx^4 + kx^3 y + \&c. = 0$ ” in compound indeterminate equations at the end of the 1700s.

However, when analysing our data, we realized that the ellipsis symbol is hardly ever defined. In dictionaries, the ellipsis is always described as something that is omitted or left-out; as a mathematical notation, in the online Wikipedia encyclopaedia (<http://en.wikipedia.org/wiki/Ellipsis>, retrieved 30 November, 2005) it does say that in mathematics the ellipsis is used to mean “so forth” to follow a pattern, but it is

almost never defined in mathematics textbooks, even though it is used extensively, particularly for sequences and infinite processes. Even in books like Lakoff and Nuñez's (2000) that extensively discuss infinite processes, and that also focus on the meaning and understanding of mathematics and mathematical symbols, we could not find a discussion of the ellipsis symbol, except referred to as "the common mathematical notation for infinity" (p. 180).

So Bryan, when faced with this new symbol had to rely on the experience of the previous tasks, thus relating the ellipsis to the 'disappearance' of terms, something that is 'cancelled out', rather than a continuing process of existing terms that have to be omitted due to the generalization. As Pirie (1998) explains, the growth of mathematical understanding occurs through a process of folding back to earlier images to give insight to the building of new, more powerful ideas and that mathematical symbolism is open to interpretation only through the medium of verbal language, which relates the mathematics to the learner's previously comprehended metaphors, where the rift between meaning and understanding can occur. This misinterpretation of the ellipsis symbol by Bryan would be a problem that would continue throughout the activity as shown below.

On the other hand, it is interesting that this misinterpretation of the ellipsis symbol led Bryan to focus on the expression  $x^k + 1$ . In parallel with trying to gain clarification on the meaning of the general notation  $(x^{n-1} + x^{n-2} \dots + x + 1)$ , he began to explore expressions of the form  $x^k + 1$  on his CAS, as illustrated in the next sections.

### **More Symbology Problems: Making Sense of the Continuing Process Described by the Ellipsis and by the Sequence of Exponents in the General Expression**

Following Bryan's exclamation that the expression  $(x-1)(x^{n-1} + 1)$  should cancel out, the teacher tried to explain what made the terms cancel out in the general expression  $(x-1)(x^{n-1} + x^{n-2} \dots + x + 1)$ , but this just added to Bryan's difficulties:

- Teacher: For it to cancel, these need to go numerically with the powers decreasing each time. So that's why you get 1...
- Bryan: So if it's decreasing, how far do you go? 'Til...?
- Teacher: You go all the way down. [...]
- Bryan: What if ..., if it's  $x^{n-1}$ , then you do  $x^{n-2}$ , then you do  $x^{n-3}$ , how far down will you go?
- Teacher: You go all the way 'til you get to  $x$  to the zero, which is 1.
- Bryan: Which is  $x$  to the  $n$  minus...?
- Teacher:  $[n]$  minus  $n$
- Bryan:  $x$  to the  $n$  minus ... but what do you get there, how do you know that?

Bryan was now very confused by the decreasing exponents. He could not see how you could get to 1, to  $x^{n-n}$  — a difficulty which is of course related to the difficulty understanding the ellipsis: since for Bryan the meaning of the ellipsis was "cancels out", and not a continuing process where something is simply omitted, he was unable

to see the sequence of exponents. The teacher tried to explain with a numerical example; then went on to the next task. But Bryan remained very confused shaking his head; at one point he grabbed the calculator apparently to use it in his search for meaning and to test his claim that an expression containing  $x^k + 1$  as a factor should indeed ‘cancel out.’

While individual work continued on the tasks, Bryan called the teacher over. He felt he had found a case,  $x^{16} - 1 = (x^8 - 1)(x^8 + 1)$ , that could ‘prove’ his supposition:

Bryan: Sir? If its  $x^{16} - 1$ , wouldn't that be the same as  $x^8 - 1$  brackets  $x^8 + 1$ , close brackets. So, what I said was, but it's only if the term is....

Teacher: Ok, what you've said is going to be very useful to what we're doing ... You're one step ahead as usual, eh? ... [Then to the whole class]: Those of you who heard what Bryan just said, it is very relevant for a change.

The teacher did not realize Bryan's confusion. He only picked up the correct ideas in Bryan's reasoning because he thought Bryan was applying the difference of squares method. But it seems that Bryan was trying to find a case not only where a term of the factored expression was of the form  $x^k + 1$ , he wanted to go further than this. This became evident when the teacher later asked Bryan to show his method to the class for the case  $x^4 - 1$ . Bryan explained it as: “*the power number, you could divide it or something*”. While classmates suggested that this was a difference of squares, Bryan clearly was still engrossed with the  $x^k + 1$  form, because he kept suggesting to further factor the term “*with the plus in the middle.*”

Later, a group discussion followed trying to answer (from another question on the worksheet), for what values of  $n$  the complete factorisation of  $x^n - 1$  would: (i) contain exactly two factors; (ii) contain more than two factors; (iii) include  $(x + 1)$  as a factor. When the teacher said: “*So, you should have gone beyond the initial conjecture that it's just  $(x - 1)(x^{n-1} + x^{n-2} \dots)$ ,*” Bryan exclaimed: “*Sir, I don't understand that*”. Bryan was still obsessed with trying to understand the notation. He stepped up to the whiteboard; and asked

Bryan: “When you go:  $x$  minus 1 and then you continue on, right?, for a long time, trying to cancel them out,  $x$  minus 2, then you go  $x$  to the minus 3 [but he wrote ‘ $n^{-1} + n^{-2} + n^{-3}$ ’], how do you know when this [circling the last exponent] is zero? How do you know when it is zero?”

Despite his language mistakes, he seemed to be asking when the sequence of exponents  $n - 1$ ,  $n - 2$ ,  $n - 3$  in the expression  $x^{n-1} + x^{n-2} + x^{n-3} \dots$  would become zero.

Teacher: “It depends on  $n$ . That is just how you write it”.

Bryan “But... When you go like this [writing an ellipsis] all the time?”

The teacher simply assented with a yes, misunderstanding Bryan's question; Bryan gave up asking, though he was still confused and kept shaking his head. Clearly he still did not understand the ellipsis notation or how the sequence of powers is defined.

The next session, the teacher began by re-writing on the board the general formula  $(x^n - 1) = (x - 1)(x^{n-1} + x^{n-2} + \dots + x + 1)$ ; Bryan immediately expressed his concern:

Bryan: I don't like that.

Teacher: That's right [referring to the formula], isn't it Bryan? But you don't like that, because?

Bryan: Because I don't like the dots. I don't think it is a real answer"

Teacher: It's a general situation.

### The Use of the Tool to Explore the Factorization of $x^k + 1$

The last task of the activity was to prove or explain why  $x + 1$  is always a factor of  $x^n - 1$  for even values of  $n \geq 2$ . For a while the students worked on their calculators, then they shared their 'proofs' in a group discussion. While a couple of students went to the board to explain their 'proofs,' Bryan was very restless. He desperately wanted to show what he had been working on.

When invited to the board himself, he picked up the difference of squares method that he had used in the previous session. He wrote that, if  $n$  is even,  $x^n - 1 = (x^{n/2} - 1)(x^{n/2} + 1)$ . He asserted that the first factor would be able to be factored further like they had done in previous tasks, but his focus was on the second factor. He explained that  $x^n + 1$  for  $n$  being 4, for example, would equal  $(x + 1)(x^3 - x^2 + x - 1)$  and would therefore have  $x + 1$  as a factor. He said that he had tried it out and it worked. But some of his classmates and the teacher pointed out that that was not correct, and the teacher erased it. It was clear that Bryan had been trying to factor cases of the form  $x^k + 1$  on the calculator and had noticed that when it factored out, he would get a factor with alternating signs. His problem was that he picked the wrong example ( $n = 4$ ).

Another student, who had been sitting beside Bryan during the previous class session, came forward to pick up the argument. He chose to illustrate the conjecture regarding alternating signs with the example  $x^{10} - 1$ , which when fully factored yielded  $(x - 1)(x + 1)(x^4 + x^3 + x^2 + x + 1)(x^4 - x^3 + x^2 - x + 1)$ , thus showing that  $x^5 + 1 = (x + 1)(x^4 - x^3 + x^2 - x + 1)$ , and that  $x^k + 1$  is refactorable for certain values of  $k$ .

### FINAL REMARKS

In this paper we have illustrated some difficulties that can arise in understanding the general notation of polynomials of undefined degree. In the case of Bryan, there were two difficulties: a misunderstanding of the meaning for the ellipsis symbol (not discussed elsewhere in the literature) and difficulties in making sense of the general sequence of decreasing exponents. In the end, we do not know whether Bryan's problems with the ellipsis notation were solved, but we did notice a marked improvement in the use of the general notation  $(x^{n/2} - 1)(x^{n/2} + 1)$ , which we attribute to his explorations with the calculator. Berger (2004) has argued, that the meaning of a new mathematical sign that is presented to a student, evolves through

communication and functional use of the sign in mathematical activities embedded in a social context; so we would expect that Bryan eventually will make sense of that symbol. On the other hand, it is very interesting how the support of the CAS calculator, in conjunction with the task questions and the group interactions, allowed Bryan and his classmate to work toward a new general expression that had not been foreseen: that, for  $n$  odd,  $x^n + 1 = (x + 1)(x^{n-1} - x^{n-2} + \dots - x + 1)$ . (Further discussion of the  $x^n + 1$  conjecture, is found in Kieran and Drijvers (submitted for publication.) We do not believe the motivation and ability to generate and explore this conjecture would have been possible without the support of the CAS.

**Acknowledgments** The research presented in this report was made possible by the INE Grant #501-2002-0132 from the Social Sciences and Humanities Research Council of Canada. We express our appreciation to the students and teachers who participated in the research and to Texas Instruments for providing the TI-92 Plus calculators used in the study.

## References

- Artigue, M. (2002). Learning mathematics in a CAS environment: The genesis of a reflection about instrumentation and the dialectics between technical and conceptual work. *International Journal of Computers for Mathematical Learning* 7, 245–274.
- Arzarello, F. (1998). The role of natural language in prealgebraic and algebraic thinking. In H. Steinbring, M.G. Bartolini Bussi & A. Sierpiska (Eds.), *Language and communication in the mathematics classroom* (249-261). Reston, VA: NCTM.
- Berger, M. (2004). The functional use of a mathematical sign. *Educational Studies in Mathematics* 55, 81-102.
- Cajori, F. (1928/9). *A history of mathematical notations* (Vols I,II). LaSalle, IL:Open Court.
- Euler, L. (1797). *Elements of algebra* (Vol II). London: J. Johnson (St. Paul's Church-yard).
- Kieran, C. & Drijvers, P. (submitted). *The co-emergence of machine techniques, paper-and-pencil techniques, and theoretical reflection: A study of CAS use in secondary school algebra*.
- Kieran, C. & Saldanha, L. (in press). Designing tasks for the co-development of conceptual and technical knowledge in CAS activity: An example from factoring. In K. Heid & G. Blume (Eds.), *Research on technology and the teaching and learning of mathematics: Syntheses, cases, and perspectives*. Greenwich, CT: Information Age Publishing.
- Lagrange, J.-b. (2000). L'intégration d'instruments informatiques dans l'enseignement : une approche par les techniques. *Educational Studies in Mathematics* 43, 1–30.
- Lakoff, G. & Núñez, R. (2000). *Where mathematics comes from: How the embodied mind brings mathematics into being*. New York: Basic Books.
- Mounier, G. & Aldon, G. (1996). A problem story: factorisations of  $x^n - 1$ . *International DERIVE Journal* 3(3), 51- 61.
- Pimm, D. (1987). *Speaking mathematically: Communication in mathematics classrooms*. London: Routledge.
- Pirie, S. (1998). Crossing the gulf between thought and symbol: Language as (slippery) stepping-stones. In H. Steinbring, M.G. Bartolini Bussi & A. Sierpiska (Eds.) *Language and communication in the mathematics classroom* (7-29). Reston, VA: NCTM.



# A TEACHER'S METHOD TO INTRODUCE STORY-PROBLEMS: STUDENT-GENERATED PROBLEMS

Adalira Sáenz-Ludlow

University of North Carolina at Charlotte, USA

*The paper analyzes the method of a third-grade teacher to elicit the generation of story-problems on the part of the students throughout the school year. The teacher triggered the students' creativity and encouraged them to use their personal experiences and their imagination to make stories and to take into account numerical relations to ask numerical questions related to their numbers. The teacher first started with a story from her own personal experience, generated two questions from her data, and invited the students to generate new questions. Students answered all questions operating mentally with the numbers and explaining their ways of operating using natural language and idiosyncratic symbolizations. The teacher's activity provided her with an opportunity to assess the students' conceptualization of numbers and their flexibility to operate with them in ways different from the use of traditional algorithms. Simultaneously, students were able to self assess their own understanding of numbers and their conceptual progress. By the end of the school year, students were willing to attempt the solutions of story-problems that surpassed the difficulty of textbook story-problem for their level.*

## THEORETICAL CONSIDERATIONS

Documents from different educational organizations have advocated a synergistic method for the teaching of mathematics: Curriculum and Evaluation Standards for School Mathematics (NCTM, 1989), Everybody Counts (NRC, 1989), Professional Standards for Teaching Mathematics (NCTM, 1991), A Call for Change (MAA, 1991), Assessment Standards for School Mathematics (NCTM 1995), Principles and Standards for School Mathematics (NCTM, 2000). This method encourages a conceptual and collaborative interaction between teacher and students that brings to the fore the complementarities between individuality and partnership, subjectivity and intersubjectivity, idiosyncrasy and conventionality, teaching and learning. Teacher and students working in collaboration create a classroom environment in which all feel active participants in a community where listening, interpreting, expressing, explaining, and justifying by means of language and other signs naturally emerge and are expected. That is, communication becomes a dynamic semiotic interchange in which teachers and students give and take. We agree with Freudenthal that in this semiotic interaction students' understanding undergoes "a succession of changes of perspective, which should be provoked and reinforced by those who are expected to guide them" (1991, p. 94).

The synergy in the semiosis of the interchange puts on the shoulders of teachers a new set of expectations and obligations with themselves and the students. Teachers need to focus more on the students' emergence and evolution and mathematical

meanings and their acts of understanding. In order to do so, they have to learn to note their own personal actions and those of the students; they have to learn to assess and interpret what they note and to map out projected lines of action. Likewise, students also have to learn to do so according to their own needs and self-developed goals. As von Glasersfeld (1995) points out, abstracting and assimilating as acts of understanding must be carried out by the individual because they involve, under all circumstances, the persons' own experiences. In summary, a synergistic/collaborative method of learning and teaching requires both the students' involvement in co-constructing their own mathematical understanding and the teachers intentions to teach in harmony with the students' current knowledge making their actions correspond to their interpretations of the students' means of acting.

## **METHODOLOGY**

### **Teaching experiment**

The teaching-experiment methodology, as initially conceptualized by Steffe and colleagues (Cobb and Steffe, 1983), encompasses the social interaction between student and teacher; although it focuses only on the analysis of the arithmetical activity of the students. When this methodology is extended to the classroom and when the intersubjectivity of the participants is considered in tandem with the arithmetical activity of the students, it focuses not only on the analysis of students' arithmetical reasoning but also on the teacher-student and student-student actions and interactions (Cobb and Yackel, 1995, Yackel, 1995, Cobb, 2000).

Following a classroom teaching-experiment methodology similar to that of Cobb, and colleagues, we conducted a yearlong whole-class teaching experiment with a group of third graders (5 girls and 9 boys); these students attended an elementary school that was considered to be an at-risk school.

The teaching experiment in which the third graders participated consisted of daily classroom teaching in which the third-grade teacher taught the arithmetic class and the researcher was a participant observer. Dialogical interactions between teacher and students and students themselves characterized each teaching-learning episode. In each episode, the teacher made an effort to "see" students' interpretations and solution strategies from their own perspectives. Consequently, to understand the students' conceptualizations and their own interpretations of arithmetical tasks, the teacher had to interpret, in parallel, both her own arithmetical actions and those of the students in order to sustain a meaningful dialogical interaction by closely following the students' acts of understanding.

In the prior school year, the teacher participated in a summer camp with teachers and children using the above methodology. Subsequently, the teacher and the researcher team-taught the arithmetic class to her fourth-grade class. Most of the time, the roles of teacher and researcher were reversed; the researcher took the role of the teacher and the teacher was the participant observer. The teacher also participated in theoretical courses, taught by the researcher, to further her understanding of what was

happening in the classroom. In both school years, the researcher and the teacher engaged in daily conversations about the nature and purposes of the arithmetic tasks to be posed to the students, the students' numerical strategies, the students' use and creation of signs, and the mediating role of those signs in the students' conceptualizations.

### **Classroom Mathematical Activity**

The arithmetic instruction these students received in the prior school years could be characterized as traditional in the sense that students were expected to perform arithmetic computations using only conventional algorithms explained to and modeled for them by the teacher. Used, as they were, to hear first the teachers' explanations, the students, at the beginning of the school year, waited for specific directions when given an arithmetic task. But when the teacher did not respond to their expectations, they started to rely on their own reasoning. A common practice in the teaching experiment was to pose oral and written arithmetic tasks for the students to solve mentally. After allowing appropriate time, the teacher proceeded to the whole-group discussion in which students wrote, explained, and justified their solution strategies and ways that enabled them to find their answers. The rest of the students were expected both to listen carefully to the solution and to express their agreement or disagreement with justification. Soon, students began to take on responsibility for their own thinking and the classroom social and socio-mathematical norms (Yackel and Cobb, 1996) began to change. The classroom dialogical interactions improved as the students felt that their contributions were taken into account and their solutions were validated and accepted by the other members of the class.

### **Instructional tasks and data collection**

The research team generated, in advance, the instructional tasks for the teaching experiment. However, some tasks were modified and new ones were generated to accommodate the cognitive needs of the students. In general, the generation of instructional tasks and the research activity co-evolved in a synergistic manner. The guiding principle for the preparation of instructional tasks was both to facilitate students' broad conceptualization of natural numbers in terms of different units and the representation of these numbers using numerals and number words. The arithmetical tasks used allowed the students freedom to symbolize and to explain, in their own ways, their numerical thinking, their numerical relations, and their solution strategies.

To analyze the evolving classroom arithmetical activity, the lessons were videotaped and field notes were kept on a daily basis. The task pages, students' scrap papers, and copies of overhead transparencies used by the students were also collected. All data was chronologically organized.

## Story-problems

Although all the arithmetical tasks were created and orchestrated by the researcher, the teacher initiated a yearlong exploration of the teaching of story-problems and the researcher became her collaborator. This exploration was then coordinated with the other tasks already planned for the teaching experiment. The teacher first started by modeling the generation of a story-problem using her own life experiences and after generating some questions about her data she invited the students to generate other questions. Then, she challenged the students to generate their own story-problems and to write them down. During her language arts class, the students edited the problems and wrote them on decorated paper provided by the teacher. The teacher collected the problems and made transparencies. Each student was supposed to do two things: (1) to solve his/her own problem and (2) to pose the problem to the class. Each student took the role of the teacher, posed the problem to the class, interpreted the solutions of his/her peers, and tried to find whether or not the other students agreed with the solution strategies presented and why. All the fourteen problems were solved in this manner. The process took 10 classes (two weeks) of 50 minutes each. The same process was repeated two more times during the school year, in Christmas and Valentine's Day. Finally, from the end of February on, the teacher posed the students story-problems that surpassed the difficulty of the third-grade textbook story-problems; in addition, they were willing to undertake the solutions of those problems individually. During the problem-solving sessions, the classroom interactions between teacher and students followed the pattern of interaction established throughout the teaching experiment but it was enhanced due to the students' increasing self confidence in their numerical ability.

At the end of March, the researcher organized the problems generated by the students and the solutions and explanations given to each problem and made a bounded notebook entitled "*Our Story-problems*". This notebook was presented to class and placed in the classroom on the shelf designated by the teacher for the students' projects. It was surprising to see the students use their free time to go over the problems and the written solutions. It was even more surprising to see them start mathematical conversations based on the comparisons of the solutions to particular problems. Since story-problems were also part of the arithmetical tasks prepared for the teaching experiment, we were encouraged to pose to the students more challenging problems than we would have had if the student-generated problem activity had not been initiated by the teacher. This is to say that the teaching experiment co-evolved with the initiative of the teacher.

In what follows, we analyze the teacher's method; the structure of some of the story-problems generated by the students; and the merits of this type of method to motivate students' creativity in their conceptualizations of number, numerical relations, symbolizations, and operations with numbers.

## ANALYSIS

The first problem was interactively generated by the teacher and the students. Based on her children's Halloween experiences, the teacher wrote the following story on the board. "My three daughters Mary, Kate, and Megan went trick-or-treating last night. Mary collected 11 candy bars, Kate 6, and Megan 15. I want to know: (a) how many candy bars Kate and Mary collected? And (b) how many more candy bars did Megan collect than Kate?" The students answered these questions operating with the numbers mentally. Different solution strategies were presented to the class. Then, the teacher invited the students to generate more questions using the data given. They asked: (a) how many candy bars did they collect altogether? And (b) how many more candy bars did Megan and Kate have than Mary? The teacher wrote the questions on the board and, again, students answered these questions mentally in different ways.

The majority of the problems generated by the students were about addition and subtraction although multiplication was also implicit in some of them.

1. I had 10 candy bars. I got 30, and then I got 40 more. I got 40, then I got 30, then I got 40 more. Will you *add it all up*?
2. I spent \$50 dollars on my sister's Ruth gift, \$50 dollars on my sister Ashley, \$100 on my Mom, \$2000 dollars on my Dad, and \$3000 thousand dollars on my brother. How much money did I spend *altogether*?
3. I had \$100 dollars. You had only half of what I had and then we got 14 dollars. How many dollars do we have *together*?
4. Adam saw a parade with 63 cars in it. Fourteen of the cars were *red*. How many cars *were not red*?
5. Deidre *works* 147 days each year. How many days *does* she *not work* each year?
6. I had 300 pieces of candy. I gave 30 pieces of candy away. How many pieces do I have *left*?
7. I had \$2000 thousand dollars. I got Mrs. Ludlow a very special gift that cost \$900 dollars. How much money do I have *left*?
8. My mom had one thousand dollars and she wanted to buy a gift for me. Now she has only \$125. How much money did she *spend*?
9. Kristal wants to buy a TV for \$157 dollars. She has \$29 dollars. *How much more money* does she need?
10. I have one thousand friends. Another person has only three friends. *How many more* friends do I have?
11. I have two thousand pieces of candy and my Mom has ten pieces. *How many more* pieces of candy do I have than my Mom?
12. I have one 100 slices of pizza and my brother has one 1000. He gave away 99 slices. How many slices of pizza does he have *left*?

13. I got 24 candy bars. I gave 4 bars to my Dad, 5 to my Mom and 11 to my brother. How many bars do I have *left* to eat?
14. I made one hundred cookies. I gave two cookies to each of the fifteen people in my family. Santa came and ate two cookies. Then his seven reindeer came and ate two cookies each. *How many cookies do I have now?*
15. If I eat three fourths of the apple pie, how much pie is *left*?
16. I have thirty pizzas. Melinda ate thirty halves. How many *halves* are *left*? How many *pizzas* did Melinda eat? How many *pizzas* are *left*?
17. I had one hundred sixty dresses. I gave you half. How many dresses did I give you? *How many dresses do I have now?*

For the most part, students used fairly large natural numbers and solved the problems mentally. This was not surprising to us given our emphasis on mental computation and on the conceptualization of number as units of units. Students expressed their solutions in writing using conventional notation or idiosyncratic diagrams in order to present them to the other students. Since the conceptualization of fractional units was also one of the main guiding principles of the study, it did not surprise us the students' initiative to use simple fractions in their story-problems. Even though the stories were simple and tied to the students' imagination or personal experiences, the wording of the questions and the quality of some of the questions seem to be very advanced for third graders. Only a few times did they use the words "left" in subtraction problems and "altogether" in addition problems; in contrast, other complex expressions were used to frame their questions about addition and subtraction problems.

Some subtraction problems had to do with the complement of a set (problems 4, 5, 6, 7, 8, and 12) as well as the comparison of two sets (problems 9, 10, and 11); other problems required a sequence of subtractions, or a sequence of multiplications, additions and subtractions (problems 13 and 14); another problem presented extra information (problem 12). Other problems required a good conceptualization of simple fractions of continuous wholes (problems 15 and 16) while another required the conceptualization of fractions of discrete wholes (problem 17). Although the majority of the problems had only one question, some of the problems had more than one question (problems 16 and 17). The analysis of students' solutions to these problems and the role of their idiosyncratic diagrams and symbolizations in their understanding are presented elsewhere.

Given the emergence of story-problems with multiple questions, students were presented with problems of that sort. One example of such problems is the following. Sunny school has 250 students, Hoover school 150, Lincoln school 350, and St. Joseph school 300. Which school has the most students? Order the schools according to the number of students. *How many more* students attend Lincoln than Hoover? *How many fewer* students attend Hoover than St. Joseph? What is *the difference*

between the number of students attending Lincoln and Hoover? How many students attend these schools *altogether*?

Problems of this type were consecutively extended to problems about the populations of several cities as well as the population of several states. The population was given in millions. Similar questions were asked, using different ways, to linguistically indicate the operations of addition and subtraction. These types of problems helped the students to focus their attention on the type of unit while making sense of the size or magnitude of the numbers.

Another type of problem given to the students was called “riddle problems”. These problems introduced multiplication to the students and they solved them using double counting. Two examples of this kind of problems are the following:

I am a two digit number. I am a number between 25 and 35. I am a multiple of 3 and 9. What number could I be? Why?

I am a two-digit number. I am a number between 20 and 60. I am divisible by 1, 2, 3, 4, 6, 8, 12 and 24. What number(s) could I be? Why?

Another type of problem was called “project problems”. These problems, as all the other problems, were not given to the students to perform only one particular operation and therefore they were challenged to think and to develop a sense for numbers and numerical relations. The following is an example of one of the easier problems:

- (a). It takes Carol 7 minutes to ride a mile. How long does it takes for her to ride 3 miles?
- (b). Todd rode 2 miles to the store. The trip took about 12 minutes. About how long would take him to ride a mile?
- (c). One day, Todd and Carol rode bikes to the school. Todd lives half a mile away. It took him 4 minutes to get there. Carol lives one mile away. She got there in 10 minutes. Who rode faster? How do you know?
- (d). Carols’ family has 2 cars and 5 bikes. How many vehicles do they have in all? What fraction of the vehicles are bikes? What fraction of the vehicles are cars?

## CONCLUSIONS

These third-graders’ generation of story-problems indicates their progressive understanding of number, their ability to encapsulate imaginary and real life experiences into arithmetical contexts in order to establish numerical relations of interest to them. The students also indicated both their ability to incorporate their emerging understanding of fractions and their ability to take on more challenging story-problems. The level of these story-problems was beyond the level of well classified textbook story-problems requiring only one arithmetical operation to answer only one question following a procedure already modeled for the students by the teacher. The story-problems generated by these students motivated them to attempt the solution of more challenging story-problem subsequently posed to them.

The teacher's initiative to encourage the students to generate their own story-problems prompted the early introduction of story-problems planned for the teaching experiment and accelerated the students' symbolic activity and the dialogical interactions among the students and between the students and the teacher.

## References

- Cobb, P. (2000). Conducting teaching experiments in collaboration with teachers. In A. E. Kelly and R. A. Lesh (Eds.), *Handbook of research design in mathematics and science education* (pp. 307-333). Mahwah, NJ: Lawrence Erlbaum.
- Cobb, P. and Steffe, L. P. (1983). The constructivist researcher as teacher and model builder. *Journal for Research in Mathematics Education*, 14(2), 83-94.
- Cobb, P. and Yackel, E. (1995, October). *Constructivist, emergent, and sociocultural perspectives in the context of developmental research*. Paper presented at the Seventeen Annual Meeting of the North American Chapter of the International Group for the Psychology of Mathematics Educations, Columbus, Ohio.
- Freudenthal, H. (1991). *Revisiting mathematics education: China lectures*. Dordrecht: Kluwer Academic Publishers.
- Glaserfeld, E. (1995). Sensory experience, abstraction, and teaching. In L. P. Steffe & J. Gale (Eds.), *Constructivism in education* (pp. 369-383). Hillsdale, NJ: Lawrence Erlbaum Associates.
- National Council of Teachers of Mathematics (NCTM). (1989). *Curriculum and evaluation standards for school mathematics*. Reston, VA: Author.
- National Research Council (NRC). (1989). *Everybody counts: A report to the nation on the future of mathematics education*. Washington, DC: National Academy Press.
- National Council of Teachers of Mathematics (NCTM). (1991). *Professional standards for teaching mathematics*. Reston, VA: Author.
- The Mathematical Association of America (MAA). (1991). *A call for change: Recommendations for the mathematical preparation of teachers*. Washington, DC: The Mathematical Association of America.
- National Council of Teachers of Mathematics (NCTM). (1995). *Assessment standards for school Mathematics*. Reston, VA: Author.
- National Council of Teachers of Mathematics (NCTM). (2000). *Principles and standards for school mathematics*. Reston, VA: Author.
- Yackel, E. and Cobb, P. (1996). Sociomathematical norms, argumentation, and autonomy in mathematics. *Journal for Research in Mathematics Education*, 27(4), 458-477.
- Yackel, E. (1995). Children's talk in inquiry mathematics classrooms. In Paul Cobb and Heinrich Bauersfeld (editors), *The emergence of mathematical meaning: Interaction in classroom cultures*, 131-162. Hillsdale, NJ: Lawrence Erlbaum.



# “THERE’S MORE THAN MEETS THE EYE”: ANALYSING VERBAL PROTOCOLS, GAZES AND SKETCHES ON EXTERNAL MATHEMATICAL REPRESENTATIONS

Jonathan P. San Diego, James Aczel, Barbara Hodgson and Eileen Scanlon

The Open University, United Kingdom

*When learners are asked to verbalise their thoughts about multiple mathematical representations, some researchers are left to analyse utterances based on video records of activity which may have ambiguous signifiers. They are also faced with post hoc analysis of paper-based worksheets, in which temporal order has to be guessed. In this paper, attempts to minimise such methodological problems by means of recent technologies such as eye-tracking, tablet PC screen capture, digital video cameras and the latest video analysis tools are illustrated in the context of a study of the effect of varying representational instantiations on learners’ problem-solving strategies.*

## INTRODUCTION

When researchers study learners’ sense-making of mathematical representations, verbal utterances are often not enough in isolation.

For example, Ainley, Bills and Wilson (2004) recorded students’ computer screen activity:

**Student:** You need times ‘cause you need to that (*points to 15 minutes*) times twenty.  
(p. 6)

Identifying exactly what the student is signifying by “that” is important for the analysis. Instances such as this occurred many times in the data that Ainley and her colleagues presented.

In principle, were researchers to recognize ambiguous signifiers at the time, they could clarify ambiguity by asking participants what they meant. This can violate one of Ericsson and Simon’s (1984) suggested guidelines – researchers should only intervene when participants stop talking and can only say “please keep on talking.” – and potentially break concentration.

There are consequently numerous empirical studies using videos of learners’ gestures such as pointing. However, participants do not always point to what they what they are referring. It is also typically difficult from these videos to pinpoint where learners are making inferences: numerical information for example might be extracted from displayed coordinates, from a graph, or from an algebraic expression.

Another example of where verbal utterances are not necessarily enough is when learners may prefer to think on paper (Villarreal, 2000). There are also mathematical terms that students may not express verbally, and writing or sketching may help them to describe what they want to say. However, without the opportunity to do this in real time, participants may not be able to provide crucial insights into their thinking.

Pirie (1996) suggests complementing a think-aloud protocol with paper-based worksheets. However, when writing is analysed after the event, the temporal order of writing and the role of scratch work have to be guessed. In previous work we have attempted to address the challenge by videoing learners writing processes using a camcorder. Due to the limitation of visual range and learners' movement, it was difficult to see the totality of the process.

Using the latest technologies, a technique has been developed to capture, coordinate and analyse learners' gazes, real-time writing, utterances and actions. The paper illustrates analytical advantages of using this technique.

## **COMBINED THINK-ALoud, EYE-TRACKING AND HAND-WRITING PROTOCOLS**

Previous work analysing video data of students problem-solving with multiple mathematical representations emphasises the need to identify which representation is being considered by a learner as utterances are made and to examine more closely students' movement between representations (San Diego, Aczel, & Hodgson, 2004). At the same time, there is a need to somehow see what learners record on paper in real-time as it may provide important evidence such as erasure of previous inferences made. Which representations learners pay attention to and what they do with them is crucial in investigating learners' sense-making of multiple representations. It is important to see how participants are organising the processes of what they do with each particular representation as they search for a solution to a problem.

Video of an individual can be combined with other event streams such as screen activity. Doing this using previous technology, however, posed technical, practical, methodological and ethical challenges (see e.g. (Hall, 2000; Powell, Francisco, & Maher, 2003; Roschelle, 2000; San Diego et al., 2004)). Recent technologies offer new opportunities that may address some of the methodological challenges presented in the previous section. To gain insight into what a person is looking at is possible using an eye-tracking device (Hansen et al., 2001). This can also be coupled with real-time writing using tablet PC screen capture. Figure 1 provides an example of what can be collected using these technologies. The two figures on the right are both 'screen activity'. The upper-right is what the observer sees during the study. The lower-right figure is an image generated by the analysis software where

the lines, called ‘saccades’, indicate the path that the eyes took across the screen; and the circles, called ‘fixations’, show where the eye dwelled on an element of the screen for a length of time above a specified threshold. By superimposing fixations and saccades on the interface, the researcher can clearly see shifts in attention.

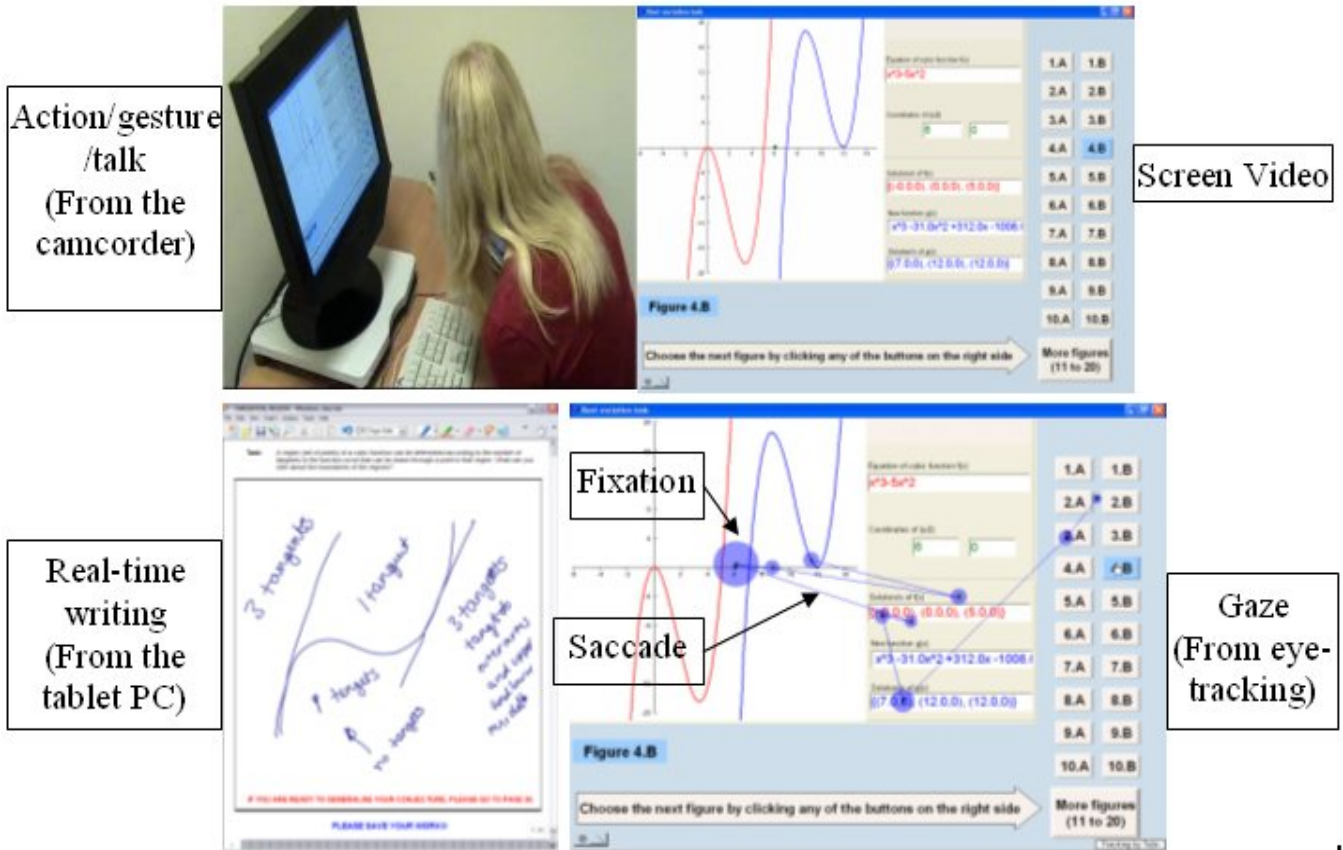

Figure 1: Examples of action, writing, screen and gaze videos

### SAMPLE EPISODE

To illustrate, we briefly discuss a sample episode from a lab-based study involving participants with A-level mathematics qualifications or higher. The study looked at the effect of varying representational instantiations (static images, on learners’ problem-solving strategies. These instantiations were “static” (non-moving, non-changing, non-interactive), “dynamic” (capable of animation through alphanumeric inputs), and “interactive” (directly manipulable graphs).

One of the tasks undertaken by participants was “An original cubic function  $f(x)$  is rotated 180 degrees about a point  $(a, 0)$ . What can you infer about the solutions of the new function?”

Figures 2, 3 and 4 show snapshot data of a participant working on this task involving multiple representations.

Start time	Action	Annotation
00:00:07:10	Talks	“You've got your two point not...”
00:00:12:10	Talks	“...and the one at two and a half”
00:00:37:20	Talks	“Ah ok! I see what the rotation means now.”
00:00:41:21	Talks	“So you gonna to get one there... one there”
00:03:02:20	Talks	I'm just thinking kind of... how they move... and they are moving in relation to that point there... so it has something to do with the distance from... the point to a...
00:03:20:17	Talks	It's the same, obviously.
00:03:24:15	Talks	So kind of a way of thinking about that but it is not that ( <i>erased -2a</i> )
00:03:45:06	Talks	The distance from plus to here is 4.7
00:03:52:10	Talks	You kind of have the distance between x and a
00:05:53:06	Talks	Let's see if it works
00:06:14:12	Talks	Hmmm! Let's go to the next one
00:06:57:08	Talks	7 and 12. WHOA!!! I can do maths! ( <i>Laughs</i> )

Figure 2: Talk by the participant

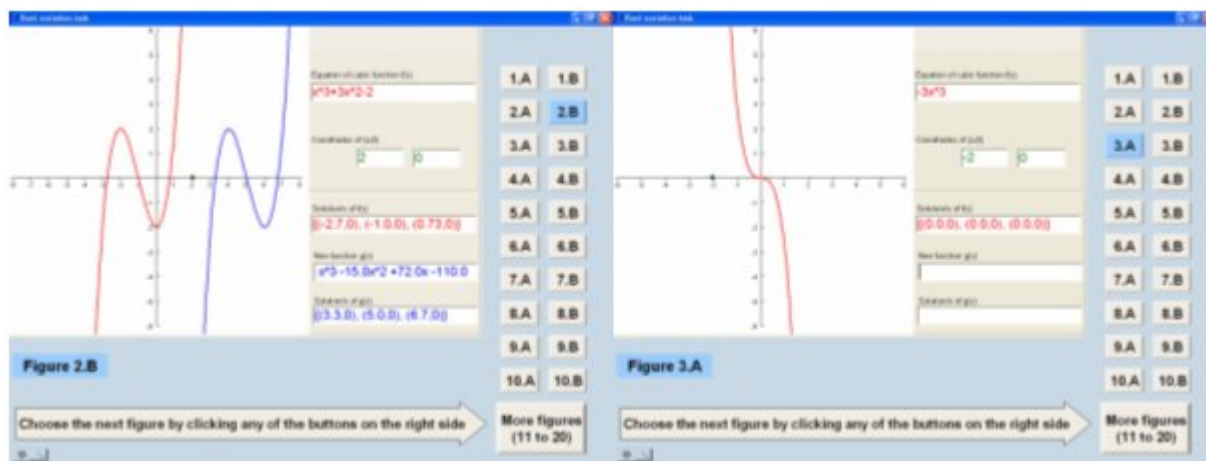

Figure 3: Screenshots of functions considered by the participant

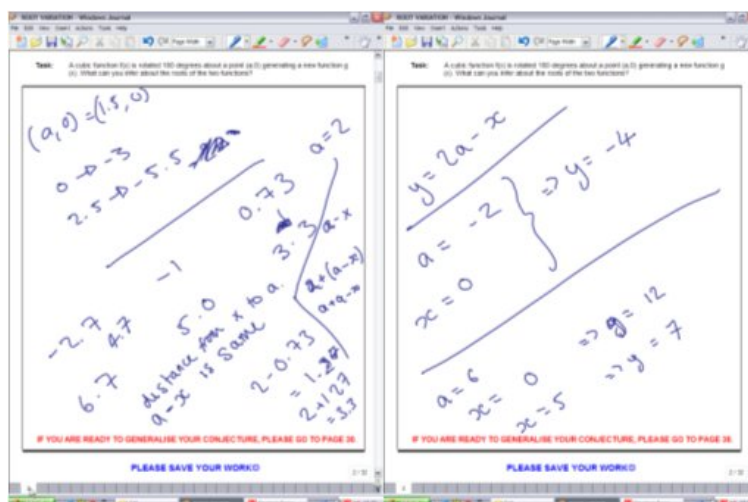

Figure 4: Final record of the participant’s writing (two pages)

**ILLUSTRATIVE ANALYSIS OF UTTERANCES, GAZES AND SKETCHES**

In isolation, the snapshot data does not suggest a strong narrative about the episode. Clearly though, a synchronous replay of talk, screen, writing and gaze data provides a richer basis for analysis than snapshots.

So, for example, the talk “you’ve got your two point not...and the one at two and a half” (00:00:07:10) is ambiguous: “point” can refer to either a graphical point or a point in a decimal number. Thus, it could be interpreted as “2.0” However, following the gaze video (Figure 5), it is clear that the participant is stating that there are two points (i.e. solution points); one is being “zero” and the other one with a value of “2.5”

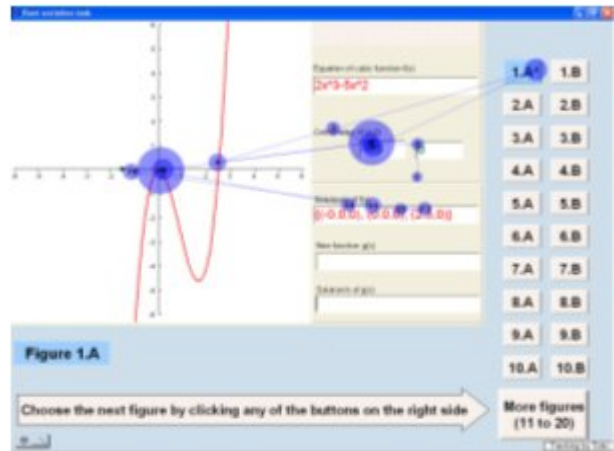

Figure 5: Gaze video

An expression like “Ah!” is normally an indication of excitement. However, it is difficult to tell what particular event elicited this behaviour. The gazes (Figure 6) show that the participant looked at all numerical representations and corresponding graphic representations during the utterance “Ah Ok! I see what the rotation means now... So you gonna get one there and one there...” (00:00:37:20). It is clear that the participant ignored the equation and only related the numeric with the graphic representations.

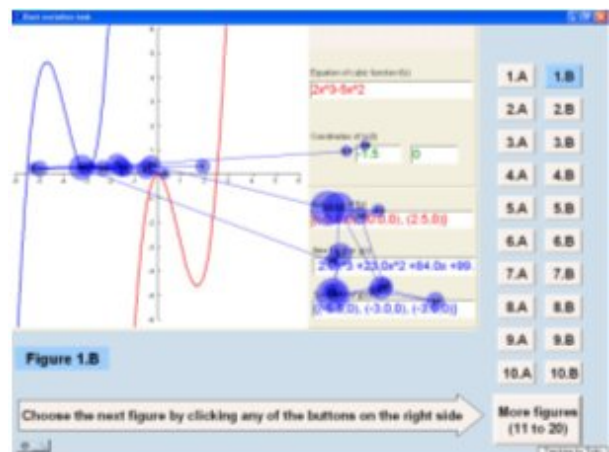

Figure 6: Gaze video

Referring to what the participant has written on paper (Figure 7) without seeing it replayed over time, it cannot be seen that the participant made sense of the numbers by assuming that one of the solutions (zero) is twice the point of rotation (-1.5). The participant also assumed that the solution is being doubled and may have been rounded. The participant only uttered “zero goes to -3 and 2.5 goes to -5.5.” but did not utter “-2a” More to this is that in the final paper. “-2a” was erased.

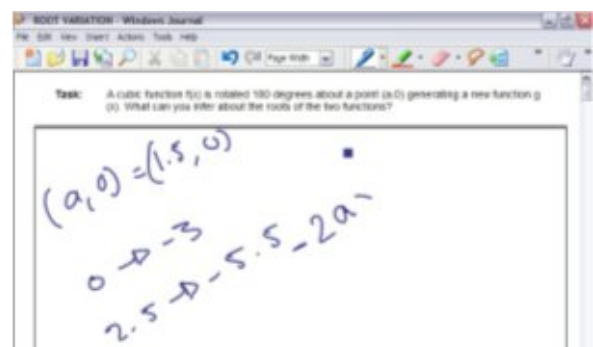

Figure 7: Writing video (start of first page)

In Figure 8, the participant then works with the numbers and is trying to connect this to the graph. The participant looked at the numbers (middle figure) and wrote them down (left figure) then she looked at the graphs (right figure) and said, “I’m just thinking how it moves...in relation to that point... it has something to do with the distance from that point... It’s the same obviously... it is not that (*erased*  $-2a$ )... the distance is 4.7...” (00:03:02:20). The sequence of gazes can provide insight into where difficulties in linking representations might be occurring.

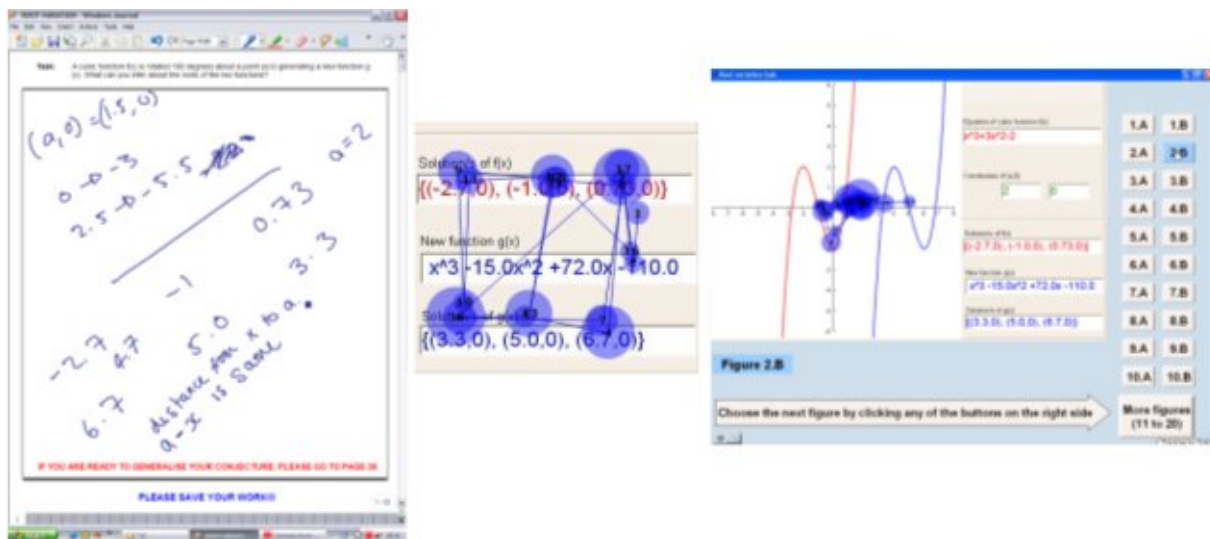

Figure 8 Writing (First page continuation) and gaze videos

Interestingly, by seeing how the writing proceeds over time, it is possible to tell how this participant was trying to make an algebraic rule (Figure 9). First she performed some numerical calculation: “ $2 - 0.73 = 1.27$ ” then “ $2 + 1.27 = 3.3$ ”. Then, she replaced each number with symbols starting with “ $2 + x$ ” then “ $2$ ” was overwritten with “ $a$ ”. Then she wrote “ $2 + (a - x)$ ” then again overwrote “ $2$ ” with “ $a$ ” and came up with “ $a + a - x$ ”.

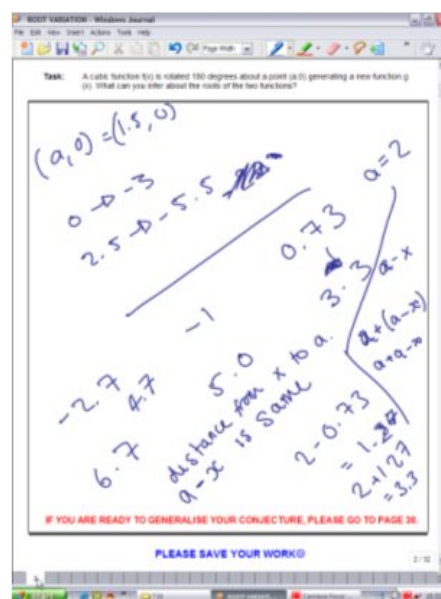

Figure 9 Final first page (writing video)

Next, the algebraic rule created was tested using the software to verify if the rule is correct. She said, “let’s see if it works” (00:05:53:06) then copied the numbers and applied the rule (left hand, Figure 10). She clicks on the next figure that reveals the solutions of the new solutions (upper-right figure) and said “Hmmm! Let’s go to the next one.” (00:06:14:12) She tried another set of calculations then again click the

next figure (lower-right figure) to verify if her rule is correct and said, “7 and 12! Whoa! I can do maths!” (00:06:57:08)

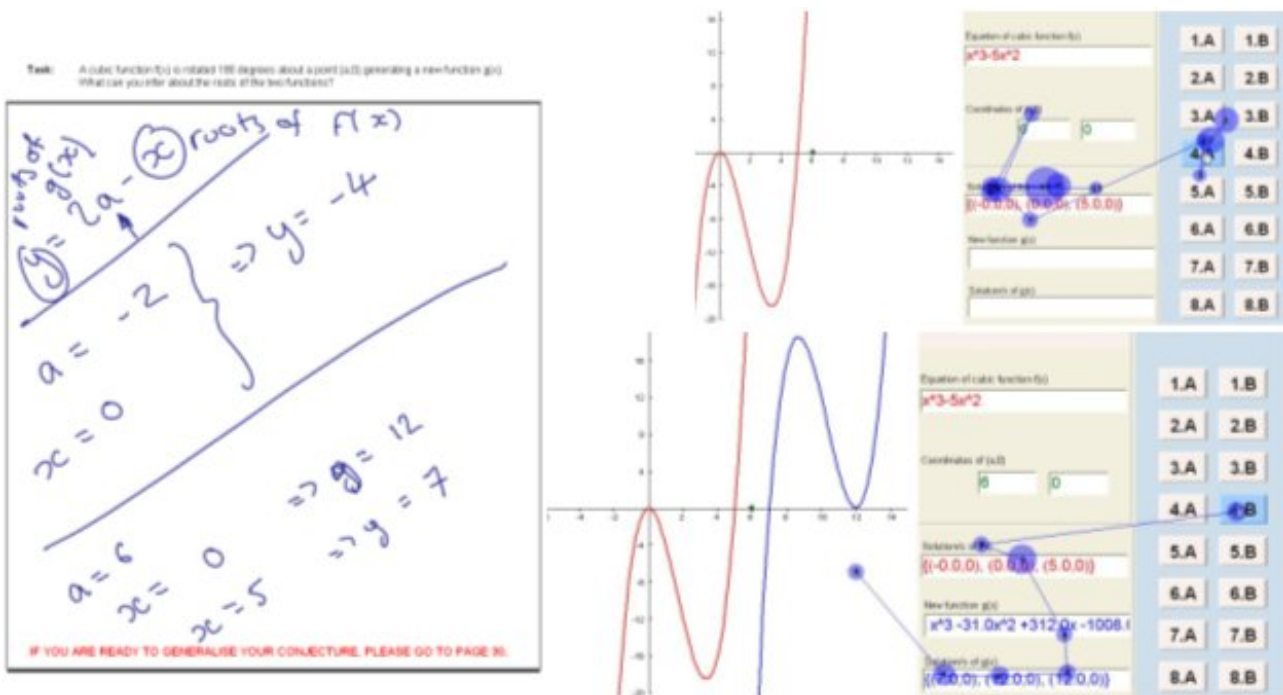

Figure 10 Writing (final second page) and gaze videos

## CONCLUSION

The short excerpt we have shown here is an attempt to show how the technique of combining gazes, utterances, actions, and writings can be used to investigate learners' interaction with multiple representations in a computer environment. However, care should be taken in organising the rich amount of data that can be derived (Powell et al., 2003).

It should be noted that eye-tracking evidence needs to be treated with care, because essential information might be picked up by peripheral vision (Hansen, 1991).

Nevertheless, in the particular study mentioned here, think-aloud, eye-tracking and writing-capture protocols have started to provide hints about how varying representational instantiations influence learners' problem-solving strategies. There was evidence, for example, that particular learner described here used both graphic and algebraic strategies when the task was presented in static form, but concentrated on working with graphic representations when a similar task was presented in interactive form.

Our view is that these techniques offer potentially interesting developments in understanding students' engagement with mathematical representations.

**Acknowledgments** The authors wish to thank: Pascal Mangold of Mangold Software & Consulting GbHM, Microsoft Research in Cambridge through Dr. Fabien Petitcolas for sponsoring a tablet PC; and, from The Open University, Prof. John Mason, Dr. Ann Jones,

Will Woods, Phil Downs, Dave Perry, Ekaterini Tzanidou and Dr. Marian Petre for their help and advice.

## References

- Ainley, J., Bills, L., & Wilson, K. (2004). *Constructing meanings and utilities within algebraic tasks*. Paper presented at the PME 28: Inclusion and Diversity, Bergen College University, Norway.
- Ericsson, K. A., & Simon, H. A. (1984). *Protocol analysis: verbal reports as data*. London: The MIT press.
- Hall, R. (2000). Video recording as theory. In A. Kelley & R. Lesh (Eds.), *Handbook of research design in Mathematics and Science education* (pp. 647-664). London: Lawrence Erlbaum.
- Pirie, S. (1996). *What are data? An exploration of the use of video recording as a data gathering tool in the mathematics classroom*. Paper presented at the Sixteenth Annual Meeting of the International Group for the Psychology of Mathematics Education, North America, Florida State University, Panama City.
- Powell, A., Francisco, J., & Maher, C. (2003). An analytical model for studying the development of learners' mathematical ideas and reasoning using videotape data. *Journal of Mathematical Behavior*, 22, 405-435.
- Roschelle, J. (2000). Choosing and using video equipment for data collection. In A. Kelley & R. Lesh (Eds.), *Handbook of research design in Mathematics and Science education* (pp. 709-729). London: Lawrence Erlbaum Associates, Publishers.
- San Diego, J. P., Aczel, J. C., & Hodgson, B. (2004). *The effects of technology on making conjectures*. Paper presented at the PME 28: Inclusion and Diversity, Bergen College University, Norway.
- Villarreal, M. (2000). Mathematical thinking and intellectual technologies: the visual and the algebraic. *For the learning of mathematics*, 20 (2), 2-7.



# NOTIONS OF VARIABILITY IN CHANCE SETTINGS

Ernesto Sánchez<sup>1</sup>

Miguel Mercado Martínez

DME, CINVESTAV, México UPIICSA-IPN, CCH-UNAM, México

*This investigation was designed to answer the question: Do students pass through the stages of: disorder, structure, variation in their construction of the notions of statistical variation? To be precise, do these three stages exist in the populations studied? If they do, what are their characteristics? To respond to these questions, a questionnaire, with some of its items taken from the survey of Watson, Kelly, Callingham & Shaughnessy (2003), was designed. A code was defined in such a way that permits the location of answers within each of the stages earlier mentioned. The questionnaire was administered on two groups of senior secondary students; the first being second grade students while the other group is already in the third grade. The students in the third grade already had a semester course on statistics, while the first one had not studied statistics.*

## INTRODUCTION

The present work is a part of an investigation whose general objective is the exploration of the conceptions of Mexican students, at different educational levels, on statistical variations. In particular, the data to be analyzed in this work were obtained from students of the second and third grades whose ages range between 16 and 17 years. The consideration of the statistical variation as a problem of educational investigation was prompted by the observation of Shaughnessy (1997) who identified three areas of opportunity for the research on stochastics, one of which arose from the question: “Where is the research on variability?” When Shaughnessy made that observation, the educational investigation on statistics variability had been very scarce / little in spite of the recognition of the central role of the variability in statistics (Moore, 1990; Pfannkuch, 1999). Nevertheless, in recent years the panorama has been changing and currently there is a modest but strong variety of investigations on the theme (for example, two special issues of SERJ magazine in 2005 were dedicated on the subject- variation).

The investigation reported here follows one of the many open lines by Watson et al. (2003). Use is made of some of the items of the survey that was designed and applied by them. Nevertheless, the present study assumes a model of understanding somehow different from what was proposed by those authors. On the other hand, a model of understanding to explain the variation reasoning was described by Reading & Shaughnessy (2004). It is made up of two hierarchies –*description and causation*–. The levels of Description Hierarchy include: D1. *Which concerns with either middle or maximum value*; D2. *Concerns with both middle and maximum values*; D3. *Discuss deviation from an anchor (not necessarily central)*. D4. *Discuss deviations*

---

<sup>1</sup> This work was supported by grant 45063-H from CONACYT (National Council of Science and Technology), Mexico.

from a central anchor (p. 214–216). Some elements of these hierarchies and incidental experiences among students, motivated one to consider a model of understanding of variability that is studied in the following sections.

## CONCEPTUAL FRAMEWORK

The concept of variation in chance settings is considered and elaborated within three important stages: the perception of the randomness, the consciousness of the probabilistic structure underlying a situation in a chance context and the understanding of the relation of this structure with the empirical data. A student is said to be *disorder, dispersion or randomness* centered, if he believes that in a random situation “any data/thing can occur”, that is to say, that any data can be obtained. In this case the fact that the data generated has a particular structure is ignored. On the other hand a student is said to be *structure* centered if he expects the data generated to have a particular or regular pattern that conforms to a theoretical distribution (in this case uniform or binomial), ignoring the randomness. Lastly, a student is *variation* centered if he takes cognizance of both the randomness or dispersion and the structure.

In a way of hypothesis a three stage model of evolution of the thinking of the intuitive notion of variation in random situations is supposed. In the first stage the subjects are *disorder* centered; that is, they see just the randomness in the data of a chance situation. Later they change to become *structure* centered, when they look for or expect a regular patterned data and, in the third and the last stage, when attempts are made by the subjects to relate the randomness and structure. This last stage is divided in two sub-divisions; in the first, the subjects do not establish relationships between randomness and regularity, in the other, they do.

This framework is consistent with the cycles of learning of the SOLO hierarchy (Structured Observed Learning Outcomes) of Biggs and Collis (1991), a hierarchy that is being utilized for educational investigations on variation (Watson, et al. 2003, Reading & Lawrie, 2004). It has five modes of functioning, similar to the phases of Piaget. In each mode, four levels are identified: Pre-structural, Uni-structural, Multi-structural and Relational.

The variation in empirical data can be considered as the result of a complex mix formed by the randomness and its underlying structure. When the randomness is not perceived, (for example, in magical explanations of the results of chance experiments) the observer is considered to be in a pre-structural level; when only the randomness is considered it is in uni-structural level, as well as when only the structure is considered; the multinomial level is when the observer attempts to combine both the randomness and structure (when attempts are made to build an appropriate and precise relation between the relational levels is attained). Then, data are explored and elements are sought to support the hypothesis made.

## METHODOLOGY

**Participants:** Seven groups of students of two Mexico City’s educational systems – CECYT and CCH were polled. Three of the seven groups are from CECYT of the

National Polytechnic Institute and the four groups of CCH of the National Autonomous University of Mexico. The first three groups interviewed were at the end of their second grade and are yet to take any course on Statistics while the other four groups polled are almost finishing their third grade and had taken a course on statistics for a semester. The topics in the course included descriptive statistics, bivariate data, and elements of probability. The information obtained is organized into two groups, A and B as illustrated in the table below:

Group	System	Number	Average Age	Previous Knowledge of statistics
A	CECYT	87	16	No
B	CCH	127	17	Yes

## INSTRUMENTS

A questionnaire of 12 items was designed, most of which were picked from the questionnaires of Watson *et al.* (2003), while others were the slightly modified version of the same. Five of the questions concern or relate to variability in contexts of games of chance while questions 6, 10, 11 and 12 relate to the subject of variability in the context of empirical distributions. In this report only questions 6, 10 and 11 will be analyzed. Information about the name and age of the students were contained at the very beginning of the questionnaire.

Question 6 asks students to suggest a distribution of frequencies of throwing a dice 60 times. Question 10 requests students to chose a distribution of extracting a ball from an urn containing three balls labeled A, B and C. The experiment is repeated 30 times with the replacement of the ball drawn, each time. Finally, question 11 has three parts, with each one having a hypothetical distribution of a binomial experience. The spinning is repeated 50 times and counting how many of those 50 times the spinner lands in a zone with number 2  $-1/2$  probability. One of the options is the theoretical binomial distribution, another one is formed by data generated from a uniform distribution, and the third corresponds to a simulated experience that has the characteristics of the experiment described. In each of the sections/parts, students were requested to determine which distribution is invented or real.

**Procedures:** The mathematics teacher of each of the groups applied the questionnaire on their students. In the group B, the teacher of Statistics asked the students to answer the questions and he offered additional marks for any of them whose results were correct while those who could not were not penalized.

To classify the answers, the following codification, similar in some aspects to that used by Watson *et al.* (2003), was employed: “Realist Appearance” (RA), is used to classify the answers to question 6 if an individual gives a distribution of frequencies, totaled 60 and whose elements fall in an interval of 4 to 16 (90% of confidence). Also RA is used to classify an answer of an individual if table one is chosen as answer to question 10. Lastly an answer is classified as RA if I-I-R sequence is chosen in

question 11: where “I-I-R” means “Invented, Invented, Realist”. “Without variation” (WV), is used to classify an answer if a uniform distribution is given in question 6 and also if table 2 in question 10 is selected as an answer to that question.

Lastly an answer is classify as WV if R-I-I sequence is followed in question 11: where “R-I-I-” means “Realist Invented, Invented”

In conclusion, “Extreme values” (EV) is used to classify the answers to question 6 if a distribution whose elements, at least one, is out of the range of 4 and 16, is given. Finally EV describes the answers if table 3 is selected as answer to question 10 and if the sequence I-R-I is followed in question 11. Where I-R-I means “Invented, Realist, Invented” while NR means “No Response or Inconsistent”.

## RESULTS

The answers to questions 6 and 10 were codified according to the categories Ra, WV, EV and NR, and their frequencies obtained and organized in tables of double entrance. The answers to the question why? In the 6<sup>th</sup> question was considered during the period of codification. In question 10 the explanations given were considered subsequently thereby making it possible to do the codification considering only the chosen options. The answers to question 11 were codified by means of terms formed by I and R that imply that the distribution formed is considered “Invented” or “Realistic” respectively and are later entered into the table of frequencies.

Group A		Question 10				
		RA	WV	EV	NR	
Question 6	RA	7 (8%)	8 (9.2%)	4 (4.6%)	0	19 (21.8%)
	WV	7 (8%)	46 (52.9%)	2 (2.3%)	3 (3.4%)	<b>58 (66.7%)</b>
	EV	2 (2.3%)	3 (3.4%)	1 (1.1%)	1 (1.1%)	<b>7 (8%)</b>
	NR	0	1 (1.1%)	0	2 (2.3%)	3 (3.4%)
		16 (18.4%)	58(66.7%)	7 (8%)	6 (6.9%)	87 (100%)

Group B		Question 10				
		RA	WV	EV	NR	
Question 6	RA	15 (11.8%)	10 (7.9%)	1 (0.08%)	1(0.08%)	27 (21.2%)
	WV	5 (4%)	41 (32.3%)	3 (2.4%)	1 (0.08%)	<b>50 (39.4%)</b>
	EV	8 (6.3%)	15 (11.8%)	3 (2.4%)	2 (1.6%)	<b>28 (22%)</b>
	NR	9 (7.1%)	10	1 (0.08%)	2 (1.6%)	22 (17.3%)
Total		37 (29.1%)	76 (59.8%)	8 (6.3%)	6 (4.7%)	127

Group	Realistic appearance		Without Variation		Extreme values	
	Question 6	Preg 10	Question 6	Question 10	Question 6	Question 10
A	21.8%	18.4%	66.7%	66.7%	8.0%	8.0%
B	21.2%	29.1%	39.4%	59.8%	22.0%	6.3%
Dif.	0.6	- 10.7	27.3	6.9	-14.0	1.7

### COMMENTS

**Realistic Appearance:** In the open-ended question number 6, the percentage of students whose answers fall in the category RA is slightly bigger than one fifth in both groups. On the other hand, in question 10 (options) the students of group B were more inclined to electing an option Ra, which represents 29.1%, with a difference of 10 points less than group A.

**Without variation:** In both groups and in both questions the majority of the frequencies fall in this category. Nevertheless, the difference in the frequencies of answer to question 6 among the groups A and B is large (27%). On the other hand, the difference in frequencies in question 10 between the groups A and B is smaller. In both cases the frequencies in group B are less than those of group A.

**Extreme values:** In the 6<sup>th</sup> question the frequencies of EV are greater than those of group B; while in question 10 the percentages of election of the option EV are similar in both groups, with 8 and 6.3% respectively.

	Group A		Group B	
	Frequency	FREC (%)	Frequency	FREC (%)
III	1	1.1%	0	0
IIR	8	9.2%	9	7.1%
IRI	17	19.5%	35	27.6%
IRR	26	29.9%	36	28.3%
RII	6	6.9%	2	1.6%
RIR	12	13.8%	31	24.4%
RRI	3	3.4%	2	1.6%
RRR	10	11.5%	7	5.5%
SN	4	4.6%	5	4%
Total	87	100%	127	100

	11.a Theoretical option		11. b Uniform Sorting		11. c Binomial sorting	
	A	B	A	B	A	B
I	59.7%	63%	31.0%	33.1%	30.9%	30.8%
R	35.6%	33.1%	64.3%	63.0%	64.4%	65.3%

It can be observed that two of every three polled people were of the opinion that theoretical distribution was invented (Class A), while one out of every three considered it real. Also one of every three people judged the second distribution (Class B) as invented, while two of every three people accept it as real. Finally, one

out of every 3 people thought that the empirical binomial distribution was invented while two of every three people considered it real. It should be noted that practically there is no differences in the frequency of answers of the groups. But there is a fact that stood out; the frequency of the students that continue the sequence RIR, in the group B, is double of that in group A.

## DISCUSSION AND CONCLUSIONS

In global terms, without distinguishing between groups A and B, there is a tendency to suggest distributions *without variation* in question 6 and to select the option – *without variation* in question 10. In question 11, the results of a) indicate a tendency of the students to consider as invented, the theoretical distribution; the results of b) indicate greater probability of considering as real the distribution with extreme values; and the results c) also indicate an inclination to see as real the distribution with realistic appearance. Curiously, these tendencies could be observed in the three cases and in the two groups in a ratio of 2 to 1. By adding cross-classified data given, it is evident that few students remained in a single category in all the questions. A similar observation was made by Watson et al. (2003) when they said: “...although the codings indicate a hierarchy of complexity, the contexts of different questions may place greater demands on students thus raising the difficulty levels for some codings” (p. 14).

This complexity is clear among the items studied. The difference between question 6 and 10 is that there is a very large number of possible answers in the first one, many of which could be suggested by idiosyncratic thinking or by personal experiences, while in question 10 the universe of possible elections is only 3. There are many differences between questions 6 and 10 when compared with question 11, but the most fundamental difference is the distribution of the corresponding situations: uniform vs. binomial. If a student in the level of structure only conceives or he keeps in mind a uniform distribution, he will propose or chose the option –“without variation” in questions 6 and 10, but he will chose “extreme values” in response to question 11. Also, the knowledge and experience that students have on such distributions will influence their answers apart from their level of perception of variation. In conclusion, with respect to the question *Do these three stages-disorder, structure and variation exist in populations studied?* The response is that they can be identified in each of the questions, but other factors such as the theoretical know-how or experiences of the students also intervene to form a more complex picture.

## References

- Batanero, C., (2001). *Didáctica de la Estadística*. Granada, España: Departamento de Didáctica de las Matemáticas, Universidad de Granada.
- Biggs, J. B.; Collis, K. F., (1991). Multimodal learning and the quality of intelligence behavior. H. A. Rowe (ed.). *Intelligence, reconceptualization and measurement*. Hillsdale, New Jersey: Lawrence Erlbaum Associates, Publishers.
- Moore, D. S. (1990). Uncertainty. In L. A. Steen (editor). *On the Shoulders of Giants: New Approaches to Numeracy*. Washington D. C., USA: National Academy Press.

Reading, C.; Lawrie, L. (2004). Using SOLO to analyze group responses. En M. J. Hoines & A. B. Fuglestad, (Eds.). *Proceedings of the 28<sup>th</sup> International Group for Psychology Mathematics Education* (Vol. 3; pp. 193-200). Gergen, Norway: Gergen University College.

Shaughnessy, J. M., (1997). Missed Opportunities in Research on the Teaching and Learning of Data and Chance, en F. Biddulph; K. Carr (eds.) *People in Mathematics Education*, Mathematics Education Research Group of Australia, Waikato, New Zealand, Vol. 1, pp. 177 –197.

Reading, C., & Shaughnessy, J. M. (2004). Reasoning about variation. In D. Ben-Zvi & J. Garfield (Eds.), *The challenge of developing statistical literacy, reasoning and thinking* (pp. 201-226). Dordrecht, The Netherlands: Kluwer.

Watson, Kelly, Callingham, Shaughnessy, (2003). The measurement of school students’ understanding of statistical variation. *International Journal of Mathematical Education Science and Technology*, 34, No. 1, pp. 1 –19.

Wild, C. J.; Pfannkuch, M. (1999). Statistical Thinking in Empirical Enquire. *International Statistical Review*, 67(3), 223-265.

**APPENDIX**

6. Imagine you threw the dice 60 times. Fill in the table below to show how many times each number might come up.

Number on Dice	Number of times it might come up
1	
2	
3	
4	
5	
6	
<b>Total</b>	<b>60</b>

Why do you think these numbers are reasonable? \_\_\_\_\_

10. There is an urn containing 3 balls, each one marked with a letter (A, B, and C). John picks up randomly a ball, writes in a board its letter, and then he replaces it to the urn. John repeats 30 times the experiment. Which one of the following boards do you think John got? Put a mark (a tick) under the board you think is the correct one.

Ball	Frequency
A	12
B	7
C	11
Total	30

Board 1

Ball	Frequency
A	10
B	10
C	10
Total	30

Board 2

Ball	Frequency
A	11
B	18
C	1
Total	30

Board 3

Why did you choose the board? \_\_\_\_\_

11. Three classes did 50 spins of the above spinner many times and the results for the number of times it landed on the part numbered 2 were recorded. In some cases, the results were just made up without actually doing the experiment. Can you identify what classes made up the results without doing the experiment?

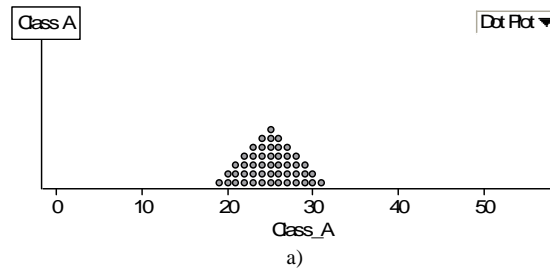
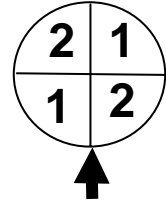

a) Do you think class A's results are made up or really from the experiment?  
 Made up                       Real from experiment

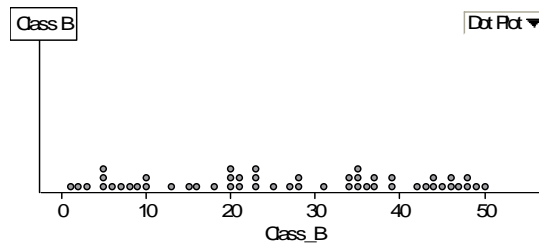

b) Do you think class B's results are made up or really from the experiment?  
 Made up                       Real from experiment

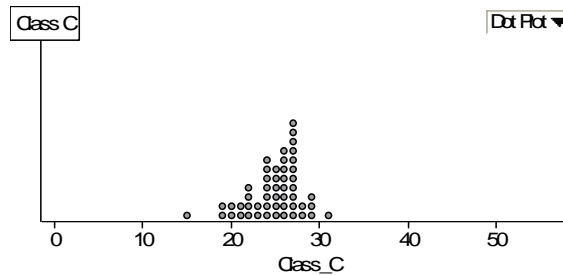

c) Do you think class C's results are made up or really from the experiment?  
 Made up                       Real from experiment



# ELEMENTARY PRESERVICE TEACHER LEARNING LEVELS

Victoria Sánchez, Mercedes García, Isabel Escudero

Departamento de Didáctica de las Matemáticas, Universidad de Sevilla, Spain

*The study presented here is a part of ongoing research, in which 'situated knowledge' and 'cognitive apprenticeship' form the framework that allows us to deal with the knowledge and the learning process of pre-service elementary school teachers in our mathematics methods courses. On the basis of a learning levels previously identified, our aims are to validate these levels and to examine the relationship between individual levels of the students of a group and the group level. Our results confirm the possibilities offered by the levels of learning for assessing the process of learning to teach, considering either the individual or the group, and suggest different ways of establishing the relationship between individual levels and group level.*

## BACKGROUND OF THE STUDY

Pre-service teacher development is a process during which knowledge and modes of reasoning similar to those of the expert should be acquired. Among the features that characterise this process, the following may be cited:

- It occurs through active participation in a context defined by 'authentic activities' (understood as ordinary cultural practices (Brown et al., 1989)).
- Learning is based on participation in different 'authentic activities', with the help of the teacher educator.
- The individual activity acquires full meaning from prior knowledge and beliefs.
- Participation in such 'authentic activities' can increase or modify the understanding of the contents involved in those activities.

This conception of situated learning causes several ideas related to the generation of the teacher's knowledge to emerge. Among these ideas, the integral nature of this knowledge, its continual development resulting from its use in new tasks, and the unending teacher training understood as continuous learning going beyond the initial education program, may be pointed out. The learning process of the future teacher may be seen as a "specific" reproductive cycle (Lave & Wenger, 1991) in which knowledge is integrated into the activity.

For us, these ideas are summarised in so-called 'learning itineraries' (García, 2000). In the itineraries, we start of a situation/task that approaches the professional tasks of the mathematics teacher. We provide to the students with conceptual tools that allow them to solve the task. These tools are understood as those concepts and theoretical constructs that have been generated from research in mathematics teacher education leading to understanding and handling situations in which mathematics is taught and learned (Llinares, 2000). They can be provided through videos, articles in mathematics education literature, or information provided for teacher educators. Through the learning itineraries, students are encouraged to think of themselves as

teachers, and share their comments and opinions with the group. From the theoretical referents, learning has been understood as ‘the simultaneous setting in motion of the different tools, interaction and communication of the information coming from them leading to reasonable decisions’. In this sense, we consider two dimensions in the social learning developed through the interactions in the groups: the learning of the group considered jointly and the learning of an individual considered as a member of the group.

The study presented here is a part of ongoing research, which aims at determining how student teachers use conceptual tools provided in the learning itineraries. In a previous work, an attempt was made to see how the use was made by different groups of the students (García et al, 2003). The characteristics identified for each group - considering the group as an analysis unit - allowed four levels to be devised:

Use of the conceptual tools by the groups	LEVELS
Conceptual tools not identified	1
Tools identified, but not related to decisions	2
Conceptual tools provided are identified and applied (used)	3
Conceptual tools are identified, applied and integrated in a more general framework	4

This paper describes our progress in characterisation of the process of learning to teach by focusing on the individual students in groups. Specifically, we attempt to

- validate the characterisation of these learning levels, both for the groups and for individual students
- examine the relationship between the individual levels of the students in the same group and the group level.

We understand validation as the possibility to categorise learning through those levels regardless of whether it is considered the learning of a group or an individual.

## METHODOLOGY

The data analysed for this paper were generated by student teachers in our mathematics methods courses through an *itinerary* that we had designed. The course lasted 60 hours. The itinerary described here was followed in that course, and took approximately ten hours to complete. The task, which is the starting point of the itinerary, was for the student teachers to interpret their pupils' production. The mathematical content involved in the task was related to school primary geometry and, in particular, plane figures. The task took the form of a case, in which we tried to show a common situation in a teacher's professional practice. In this situation, student teachers had to make a decision on how they would choose to collect information about pupils' prior ideas and knowledge, posing some questions for the

student teachers about the procedure (questionnaire, interview, informal talk, etc), the type of information they would consider relevant, and how they would assess their pupils' answers.

When the task design was complete, we searched for *conceptual tools* that should be available to the student teachers for them to be able to perform this task. The conceptual tools given to the students came from information that had been provided them about Van Hiele levels (Jaime y Gutiérrez, 1990), plane figures (Hemmerling, 1971; García y Bertran, 1989; Clemens et al, 1989), and spatial reasoning, and difficulties and mistakes in learning geometry (Dickson et al 1991). We also gave them some orientation on the subject in the Spanish curriculum at the grade-level in question.

When the itinerary had been designed, the task and the above mentioned materials were given to several groups of students. Below, we describe the sources used for gathering the information that we utilised to collect the data.

## Participants

The study included 84 primary school student teachers enrolled in two mathematics methods courses with similar characteristics. Following the students' criteria, they were divided into 16 small groups. The groups were made up of 4 to 6 students.

## Data collection procedures

Data collected includes:

- Group reports, containing the answers to the questions about the task, including the reasoning that had led them to their final decision.
- Tapes and transcripts of audio-recorded group discussions as the itinerary was being carried out
- Individual student teacher reports, including reflections on how they had contributed to the group in carrying out the task. These reports were collected three times, before, during and after group work.
- Each student teacher was interviewed individually for about 30 minutes. One of the interviews took place at the beginning of the session to collect information about their previous ideas and background concerning the task. Another was toward the end of the itinerary, focusing on the agreement/disagreement between individual positions and final group decisions.

## Data analysis

The data was analysed in the following steps: 1) The group reports were analysed by the following inductive process. Units of analysis were identified and classified taking into account the elements considered basic to the task-solving process, the presence of the tools provided in these elements, and any relationships established (or not) between tools. We were then able to identify group levels. 2) Researchers

analysed group discussion recordings in detailed, coding the transcripts on the basis of the use each individual student made of the conceptual tools in those discussions. 3) Individual reports and interviews were analysed looking for evidence of student development during the itinerary and in the justification of decisions made - from prior ideas to the identification of theoretical constructs as tools in developing a professional task.

## **RESULTS**

### **Validation of the learning levels**

Concerning validation of the learning levels previously identified, from the analysis of the group reports, we were able to identify different group levels according to their use of the conceptual tools. Five groups were included on the first level. These groups of students were clearly situated at a personal stage, with attitudes based on previous experience. They did not identify the conceptual tools as useful in carrying out the task, as illustrated in the comments quoted below, when one of the groups on this level tried to justify how they had classified the pupils' answers to the questions on the questionnaire they had designed:

“Question 3 [in our questionnaire] was meant to find out the children's ability to identify which of the shapes shown they thought were polygons. Their answers lead us to affirm that most of the students know the criterion differentiating a shape as a polygon, since 27 students answered correctly and 2 were wrong...” (G6T).

They thus went along, evaluating student responses to each of the questions on the questionnaire they had designed to collect information on their students' understanding and previous ideas, based exclusively on the number of right and wrong answers in identifying plane figures.

On a second level, students were able to identify some conceptual tools, but they did not relate that presence/absence to anything. Five groups were found to be on this level. The following response is representative of one of these groups, in which the student teachers based their evaluation on the curricular orientation and information about plane figures provided in the itinerary to find a 'progression' in the pupils' understanding:

“To establish the various steps in which we have classified the answers to the questionnaire, we represented them on a progression hypothesis. Each step is a degree of difference in knowledge, whereby the student progresses from the simplest to the most complicated:

- No knowledge of plane figures
- The student conceives of a polygon as a closed plane figure
- The concept of a polygon acquired by the student is “plane figure, closed and delimited by a straight line”
- The student knows how to group polygons by the number of sides they have
- The student recognizes the names of the polygons by the number of sides” (G2T).

There were four groups on the third level. On this level, the groups tried to make a general classification that included all the questions. They somehow went from the level of each answer to the pupil's level. The following is representative of the student teachers' explanations:

“ We formed groups to establish the general criteria:

- Do not know and do not answer
- Recognize the basic shapes
- Know the plane figures and their characteristics
- Are able to recognize the plane figures and point out their characteristics in any context”

...This classification enables us to make an initial assessment of the students' previous ideas and then use them as the starting point for the study of Geometry ...” (G2M).

Finally, there were only two groups on the highest level, in which the conceptual tools were identified and used, incorporating the relationships among them in a more general framework, as we can see in the following comments:

“The easiest way to see the results (of the questionnaire we designed) would be to make a table in which the van Hiele levels can be compared with the answers given by the children and see their situation. When we had said when we designed our questionnaire, the questions that we had included were related with the Levels 1, 2 and 3.

After checking the results, we find that the children answered Questions 1 and 4, which refer to Level 1, Visual Recognition, correctly, so it can be seen that they have arrived at this level.

On Questions 2 and 5, they seem to have rather a lot of difficulty in beginning to reason or analyse (Level 2). They are aware of the elements which comprise the figure, but are not able to relate them to each other.

Very few were able to solve Question 3, so we can see that Level 3, informal deduction, has not yet been arrived at.

In view of the questionnaires, we believe that the pupils are on Van Hiele's Level 2, and this is where we have to start to work” (G4M).

These results allowed us to validate our previous identification of levels. In addition, we were able to show the difficulty of establishing relationships among different conceptual tools, that is, the difficulty that implies their use in solving a task in pre-service elementary school teacher education programs. Program configuration through professional tasks allows student teachers to translate concepts, ideas and ways of reasoning into the process of solving those tasks. This implies the use of knowledge other than propositional knowledge that is traditionally appraised in some teacher education programs.

We think that one of the objectives for future research in mathematics teacher education should be the search for relevant professional tasks that can be incorporated into mathematics teacher education programs and that foster the use of

conceptual tools. The constructs of ‘purpose’ and ‘utility’, developed by Ainley et al. (2002) as a framework for task design by mathematics teachers might be considered in a mathematical teacher educator context. We agree with these authors in the sense that “Designing tasks that are purposeful for learners ensures that the activity will be rich and motivating” (Ainley et al, 2002, p.21).

### **The relationships between the individual levels of students in the same group and the group level**

Analysis of the individual reports and interviews enabled us to identify individual student levels in the same group. From the overall analysis of the research instruments, we were able to examine the characteristics of the individual/group level relationships. The following table focuses on one group at each of the levels found showing some of the different relationships that we identified.

Group Level	Group	Group characteristics	Individual/Group level relationship characteristics
1	G6T	There were 6 students in this group. All the students were on Level 1.	Group and student levels are the same. The students did not identify the conceptual tools, and based their assessments on previous experience. Nobody posed ‘dilemmas’ in the group discussions.
2	G2T	This group had 4 students. Two of them were on Level 2 and two on Level 1.	The two students on the highest level influenced the group’s decisions with respect to the use of conceptual tools. Nevertheless, group interaction did not cause Level 1 students to improve their level.
3	G2M	This group was made up of 5 students. All the students were on Level 2.	The individual students identified tools as belonging to different domains (learning, content, teaching, etc). These tools were ‘joined’ in the group interactions, increasing the group’s Level from the individual Level of the students.
4	G4M	There were 5 students in this group. Two of them were on Level 3, with some characteristics of Level 4, another two students were on Level 2 and the last one was on Level 2, with some Level 3 characteristics.	The generation of dilemmas in group discussions created an opportunity for constructive dialogue and helped to increase the group’s level.

## CONCLUSIONS AND LIMITATIONS

One of the goals of this study was to examine the potential of using learning levels, identified on the basis of the use of conceptual tools, for characterising the process of learning to teach. The study results point out how useful learning levels are for assessing that process, whether the individual or the group is evaluated.

*We have identified different ways of establishing the relationships between the levels of the individual students in a same group and the level of that group. Two groups in which all the members were on the same level were identified. In Group G6T, the group level is the same as the level of the students in it. We might represent the relationship in this group in the following way:  $L1 \cup L1 \cup L1 \cup L1 = L1$ . In the other group (G2M), the members of the group have identified different conceptual tools that are 'joined' in the group discussions, establishing a relationship that could be represented as:  $L2 + L2 + L2 + L2 + L2 = L3$ .*

Two groups in which the students were on different levels were also identified. In both cases, the group was situated on the highest level. Nevertheless, the relationships found are different. Two students who are on Level 2, and who lead group decisions influence the relationships in Group G2T. The relationships in Group G4M are strongly determined by the dilemmas that some of the students posed – particularly the students in transition between levels. By trying to answer those dilemmas, the group was situated at Level 4.

The different relationships identified have led us to pose a need to delve further into the suitability of level/itinerary. The itinerary we have designed might not be adequate for Level 1 students. So we asked ourselves the following questions: Should we try to find itineraries that are useful for all the groups, regardless of the level of the students in the group? Should we diversify the itineraries according to learning levels? We hope that this paper takes a step toward bringing these questions to light.

**Acknowledgment** The research reported herein has been supported by a grant from the Ministerio de Educación y Ciencia (Spain) (SEJ2005-01283/EDUC, partially financed with FEDER funds).

## References

- Ainley, J., & Pratt, D. (2002). Purpose and utility in pedagogical task design. In A. Cockburn & E. Nardi (Eds.), *Proceedings of the 26 Annual Conference of the International Group for the Psychology of Mathematics Education: Vol.2*. Norwich, UK: School of Education and Professional Development, University of East Anglia, 17-24.
- Brown, J., Collins, A. & Duguid, P. (1989). Situated cognition and the culture of learning. *Educational Researcher*, 32-42.
- Clemens, S.R., O'Daffer, P.G. & Cooney, T.J. (1989). *Geometría con aplicaciones y solución de problemas*. Addison-Wesley Iberoamericana, S.A. Madrid: Alhambra.
- Dickson, L., Brown, M. & Gibson, O. (1991). *El aprendizaje de las matemáticas*. Madrid. MEC: Labor.

- García, M. (2000). El aprendizaje del estudiante para profesor de matemáticas desde la naturaleza situada de la cognición: Implicaciones para la formación inicial de maestros. In C. Corral & E. Zurbano (Eds.) *Propuestas metodológicas y de evaluación en la Formación Inicial de los Profesores del Área de Didáctica de la Matemática*. Oviedo, España: Universidad de Oviedo.
- García, J., & Bertran, C. (1989). *Geometría y experiencias*. Madrid: Alhambra.
- García, M., Sánchez, V., Escudero, I., & Llinares, S. (2003). The dialectic relationship between theory and practice in Mathematics Teacher Education. *Proceedings of the CERME3*, Università di Pisa: Pisa University Press.
- Hemmerling, E. M. (1971). *Geometría Elemental*. México, Limusa-Wiley, S.A.
- Jaime, A., & Gutiérrez, A. (1990). Una propuesta de fundamentación para la enseñanza de la Geometría: El modelo de van Hiele. In S. Llinares & V. Sánchez (Eds.) *Teoría y práctica en Educación Matemática*. Madrid: Alfar.
- Lave, J., & Wenger, E. (1991). *Situated Learning. Legitimate Peripheral Participation*. NY: Cambridge University Press.
- Llinares, S. (2000). La práctica de enseñar y aprender matemáticas. La generación y uso de instrumentos de la práctica. *Revista de Enseñanza Universitaria* nº 18/19, 115-124



## MATHEMATICS ACHIEVEMENT: SEX DIFFERENCES VS. GENDER DIFFERENCES\*

Dora Santos\*\* Sonia Ursini\*\* Martha Patricia Ramirez\*\* Gabriel Sanchez\*\*\*

\*\*Matemática Educativa, CINVESTAV, México; \*\*\*FES-Zaragoza UNAM, México

*In this study our aim was to determine if there were significant differences in students' (12-13 years old) mathematics achievement when differentiating them by sex (boys and girls) and by gender (masculine, feminine, androgynous and undifferentiated traits). 1056 students were given a mathematical test and the Bem Sex Inventory. Results confirm that there are no significant differences when considering sex, but there are significant differences when gender is taken into account. Students (boys and girls) with masculine traits do better. Girls surpassed boys in almost all the gender categories. The sample will be followed up for two more years in order to detect changes in achievement and gender traits.*

### BACKGROUND

Over the past three decades, a considerable number of studies seeking to determine a relationship between gender and mathematics learning have been conducted in various countries. In recent years research efforts (Fierros, 1999; Zhang and Manon, 2000; Johnson, 2000; Leahe and Guo, 2001; Ericikan, McCreith, and Lapointe, 2005) show no significant differences in achievement between boys and girls as they start getting acquainted with mathematics. Nonetheless, differences favoring male students begin to emerge with time (Campbell, 1995; Mullis y Stemler, 2002). Although these studies address gender-related differences, the distinction is usually made by sex, i.e. considering individuals' biological characteristics rather than the sociocultural background that shapes their gender identity. However, gender and sex are not synonymous. Gender is a sociocultural construct, a category that sorts and organizes social relationships between human male and female (Lamas, 1986; Bustos, 1991, 1994; Gomariz, 1992; Barbieri, 1996; Scott, 1996). It is, gender is the outcome of a social, historic and cultural process that develops through practices, symbols, representations and social standards and values, and determines appropriate roles for men and women — all of this based on sex differentiation. Gender acquisition develops through a complex, individual social process. Sex, by contrast, refers to anatomical and physiological characteristics deriving from biology.

Since the seventies quantitative research began, where sex was considered as an independent variable that determined the kind of mathematics skills of men and women, based on their achievement, participation, and performance in this area. The results of these studies showed small differences between men and women, which did not allow to explain the reason for the dissimilarity in achievement, participation and performance in higher education, where more advanced math is taught (Atweh, 1995).

In the nineties, the need to consider other theories and methods to examine this fact became apparent. Thus, attention began to be paid to the social and cultural processes that boys and girls are subject to, which affect their math achievement, participation and performance. For example, Leder (1992) emphatically stated that the research paradigm used in reviewing the “women-math” issue should be replaced with “gender-math”, with emphasis on socialization processes and hidden cultural pressures, because female facts cannot be studied in isolation. Gender then emerges in the mathematics domain as an analysis category with a qualitative approach that considers the sociocultural elements in which individuals are embedded. However, when developing gender-maths studies we still very often differentiate individuals by sex (biological characteristics) rather than by gender (socio-cultural characteristics), in spite of the theories and instruments permitting to differentiate subjects by gender.

Since the seventies, as a criticism towards early views on gender roles which sustained that masculinity and femininity were opposite personality characteristics, two new theories began to develop. The gender identity model (Spence & Helmreich, 1978) and the androgyny model (Bem, 1974) promoted masculinity and femininity as separate and independent constructs. Bem contributed to this evolution in the study of gender roles by developing the concept of androgyny, having both masculine and feminine characteristics, and that of undifferentiated, having low masculine and feminine characteristics. In connection with this concept, Bem also developed a tool for the measurement of masculinity, femininity, and androgyny called the Bem Sex Role Inventory (BSRI).

## **THE STUDY**

The study we are presenting is part of a longitudinal research investigating the relationship between mathematics achievement, sex and gender traits. We present here the results of the first phase of the study. Our first purpose was to investigate if there are significant differences when comparing achievement in mathematics’ performance when students 12-13 years old are differentiated by sex (boys and girls) and when they are differentiated by gender (masculine, feminine, androgynous and undifferentiated traits). During the next two years the same sample of students will be followed up. The results will show whether or not the same results are reached when conducting studies based on sex differences or on gender differences.

## **METHOD**

A quantitative study was conducted with 1,056 students (50.7 % females and 49.3 % males) attending the first year of secondary school in Mexico. The mean age was 12.7 years old ( $d.s. = .53$ ). Students were given two instruments (described below) in order to evaluate their mathematical achievement level and their gender traits.

### **Instruments**

#### Mathematical knowledge

A 14 multi-choice items questionnaire, already validated and widely used for official testing in Mexico, was employed to test students’ mathematics knowledge. It aims at evaluating mathematics knowledge for students attending the first year of high-school

in Mexico. The items tackle students' capabilities to work with basic mathematical concepts that students should have acquired during elementary school, and which are reviewed during the first secondary school year (divisors and dividends of numbers, proportion, percentages, addition and subtractions of fractions, simple probability, ratio, pre-algebra, basic data analysis).

### Gender identification

To identify students' gender the short version of the Bem Sex Role Inventory (BSRI) was used: a 30-statement questionnaire in a 5-point, Likert-type format, intended for psychological androgyny empiric research. It provides an independent evaluation of *masculine* (10 items) and *feminine* (10 items) traits, and the possibility to categorize those presenting *androgynous* or *undifferentiated* traits. Moreover there are 10 filler items. Depending on the score obtained a subject is considered to belong to one of the four gender categories. An individual is considered as *androgynous* if he/she gets high ratings for both masculinity and femininity, and as *undifferentiated* if he/she gets low ratings in both categories. Before using it with Mexican students, we verified that the masculine and feminine traits contemplated in the BSRI are the same as socially ascribed in our country. Reliability and validity testing of the thirty-item Spanish version of the Bem scale adapted for the purposes of this study have shown the reliability and validity of this instrument.

## RESULTS

When analyzing the BSRI scores, one can immediately realize that it is not the same thing to talk about sex than to talk about gender (Table 1). The great majority of first year secondary boys and girls are distributed into the four categories (*masculine, feminine, androgyny, undifferentiated*). Two more categories were added, due to the fact that a small number of students got the same score proportion in two categories: masculine and undifferentiated (*Masc-Undif*) and feminine and undifferentiated (*Fem-Undif*).

Sex	Gender					
	Masculine	Feminine	Androgyny	Undifferentiated	Masc-Undif	Fem-Undif
Girls	10.4	20.7	41.8	20.9	3.0	3.0
Boys	25.5	7.1	28.8	33.2	3.6	1.7

Table 1 – Cross matrix table that shows the sample distribution in percentages for each of the categories regarding students' sex

It is interesting that the majority of girls of this age (12-13) can be found in the *androgyny* category, that is, they tend to have both masculine and feminine characteristics strongly developed. On the other hand, the majority of the boys show *undifferentiated* traits, that is they have low masculine and feminine characteristics.

Our longitudinal study (in course) will provide evidence on how gender identity changes over time.

In order to establish the mathematical achievement level of the students, they were classified in two sets: the ones that had more than 60% correct answers in the knowledge test, and the ones that had less than 60%. With this grouping it was evident that only 13.8% of the sample had at least 60% correct answers. When analyzing the data considering students' sex (Figure 1), there were no significant differences found ( $\chi^2 = 2.71$ , with  $p > .05$  and  $df = 3$ ), which corroborates results found in recent international research reports.

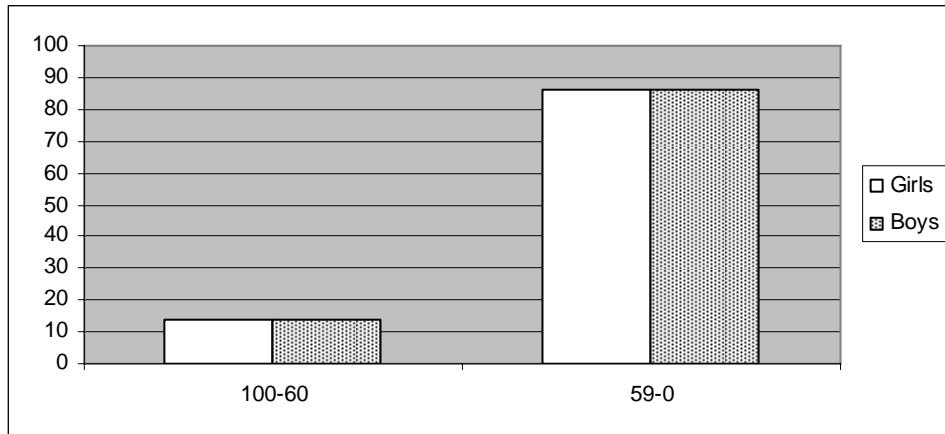

Figure 1 – Percentages of correct answers for boys and girls

Nevertheless, when answers were analyzed differentiating by gender (Figure 2), significant differences ( $\chi^2 = 19, 53$ , with  $p < .01$  and  $df = 5$ ) between the different categories appeared, even though the majority obtained less than 60% of correct answers.

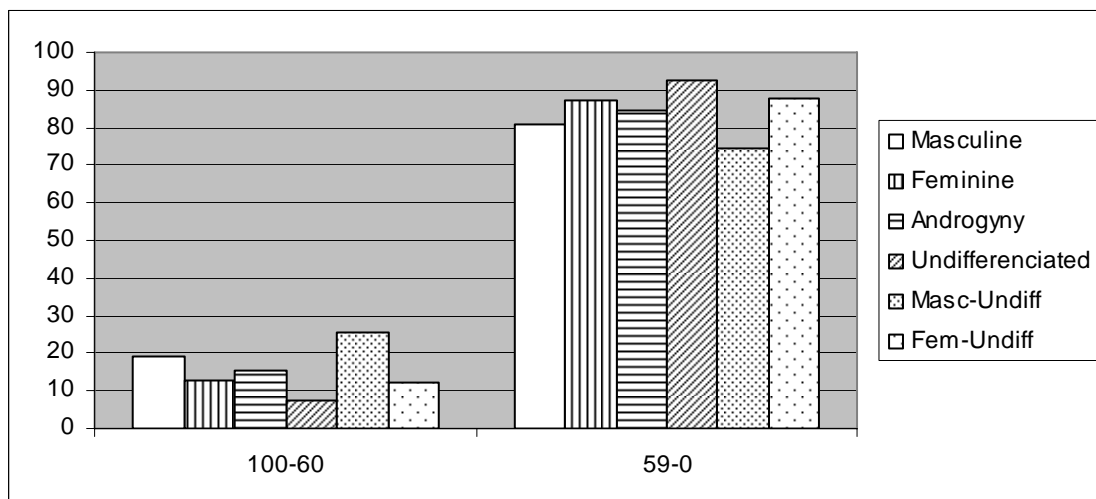

Figure 2 – Percentages of correct answers by gender

In Figure 2 it can be appreciated that *masc-undiff* students are the ones that get the best marks, followed by the ones with *masculine* traits. At the same time, students that have fewer correct answers are the *undifferentiated* ones.

In order to distinguish the different gender traits within each sex, Figure 3 shows the results for girls. Significant differences between the different gender traits ( $\chi^2 = 13, 35$ , with  $p < .05$  and  $df = 5$ ) were found. In particular, it can be observed that *masculine* girls and *fem-undiff* girls are the ones that get the best results. Girls with *undifferentiated* gender traits are the ones that get less correct answers.

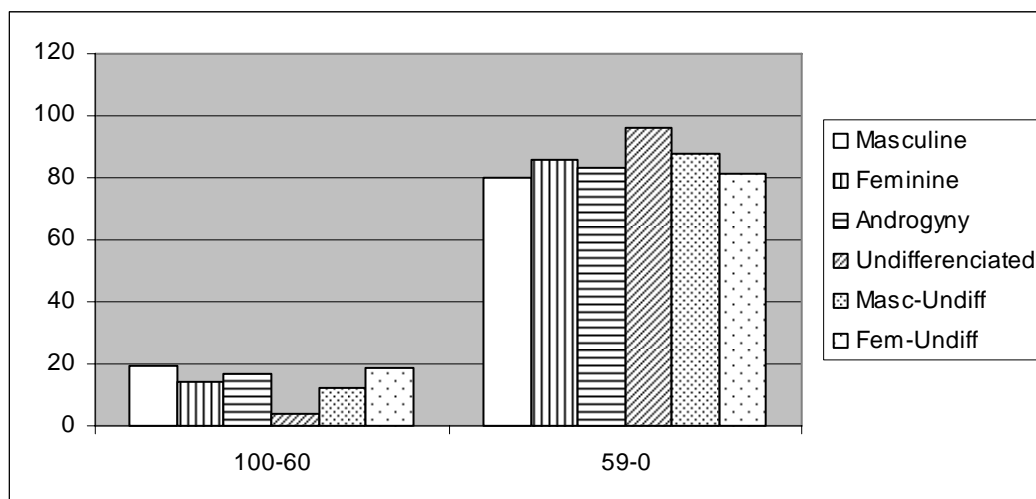

Figure 3 – Percentages of correct answers by gender considering only girls

In the boys' case (Figure 4) differences between genders are also significant ( $\chi^2 = 15, 80$ , with  $p < .01$  and  $df = 5$ ). It can be noted that *masc-undiff* boys are the ones that obtained higher scores, meanwhile the *fem-undiff* boys are the ones with the lowest score. It is important to realize that the differences between categories in the boys case (Figure 4) is stronger than for the girls case (Figure 3).

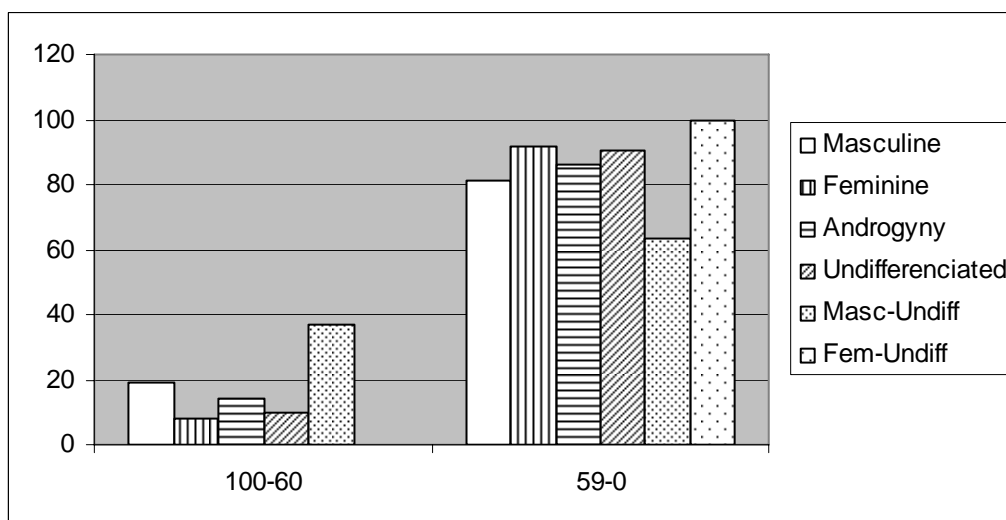

Figure 4 – Percentages of correct answers by gender considering only boys

When comparing the results within each gender category differentiating by sex (Table 2), we find that for the majority of the gender categories there are significant differences between sexes, favoring girls. Several  $\chi^2$  tests were used to evaluate if there were significant statistical differences between the percentage obtained by girls and boys in each gender category.

<i>GENDER/SEX</i>	<i>SCORE</i> <i>100%-60%</i>	<i>SCORE</i> <i>59%-0%</i>
<i>Masculine/G</i>	19.6	80.3
<i>Masculine/B</i>	18.8	81.2
<i>Feminine/G</i>	14.4	85.6
<i>Feminine/B</i>	8.1	91.9
<i>Androgyny/G</i>	16.5	83.4
<i>Androgyny/B</i>	14	86
<i>Undifferentiated/G</i>	3.6	96.4
<i>Undifferentiated/B</i>	9.8	90.2
<i>Masc-Undiff /G</i>	12.5	87.6
<i>Masc-Undiff /B</i>	36.8	63.2
<i>Fem-Undiff /G</i>	18.8	81.3
<i>Fem-Undiff /B</i>	0	100

Table 3 – Store percentages by gender differentiated by sex (G- Girls, B-Boys)

The results were the following:

For *fem-undiff* students significant differences were found favoring girls ( $\chi^2 = 18,8$ , with  $p < .01$  and  $df = 1$ );

For *masculine* students significant differences were found favoring girls ( $\chi^2 = 5,44$ , with  $p < .05$  and  $df = 1$ );

For *feminine* students significant differences were found favoring girls ( $\chi^2 = 8,89$ , with  $p < .01$  and  $df = 1$ );

For *androgynous* students significant differences were found favoring girls ( $\chi^2 = 4,41$ , with  $p < .05$  and  $df = 1$ ).

The only gender category for which a significant difference favoring boys was found is the *undifferentiated* one ( $\chi^2 = 8,05$ , with  $p < .01$  and  $df = 1$ ).

The category where there no significant difference between sexes was found is the *masc-undiff* one ( $\chi^2 = 2,77$ , with  $p > .05$  and  $df = 1$ ). This last result could be due to the low absolute frequency of students corresponding to this category in contrast with the other categories.

## CONCLUSIONS

This study investigated the mathematics achievement level of 12-13 year's old students, in order to see if there were significant differences due to sex or to gender traits. The results obtained specifically show that:

1. When variable sex is considered, no significant differences in students' mathematics achievement is detected, which confirms results obtained in other recent studies.
2. When gender identity (without considering students' sex) is taken into account, significant differences appear between genders favoring students (both, boys and

girls) with masculine-undifferentiated (*Masc-Undiff*) traits followed by students with *Masculine* traits.

3. When sex is considered within a specific gender trait, significant differences appear between sexes. Girls performed significantly better in four of the six categories (*Fem-Undiff*, *Masculine*, *Feminine*, *Androgynous*). Boys performed better only when categorized as *Undifferentiated*. Both sexes performed equally well when gender identity was *Masc-Undiff*.

Our results stress the importance of doing research in which the socio-cultural issues, which define students' gender traits, are considered and not only the biological characteristics. Gender traits reveal issues that remain hidden when only sex differences are considered. Following Leder (1992) we want to stress once more that "gender-math", with emphasis on socio-cultural aspects, should be the new paradigm. The research reports that show no sex differences in students' achievement should be revisited from this perspective. The issue to be looked at now is how strong socio-cultural influences can affect girls and boys mathematics achievement, and how the social construction of gender traits is gradually influencing their capabilities to learn mathematics.

Recent research reports that when older students are tested, significant differences in mathematics achievement favoring men appear. We question if the population that is favored is the male one or the one that has *masculine* traits. We base this questioning in the results obtained in this study, that shows that students with *masculine* traits did better than the others. It might be that with age, due to socio-cultural influences, girls become more "feminine" and boys more "masculine" which will give the idea that men do better than women, and not that students with *masculine* traits do better. If this is the case, we will assume that gender characteristics can influence the achievement level.

In order to see how gender changes with aging and how this correlates with mathematics achievement we will follow the group of students that has participated in this study during two more years.

## References

- Atweh, B. (1995). Social Context in Mathematics Classrooms: Social Critical and Sociolinguistic Perspectives. *Annual Meeting of the American Educational Research Association*. San Francisco, USA.
- Barbieri, M. Teresita de (1996). Certezas y malos entendidos sobre la categoría de género. In *Estudios básicos de Derechos Humanos IV*. Instituto Interamericano de Derechos Humanos. Costa Rica.
- Bem, S. L. (1981). *Bem Sex-Role Inventory*. Redwood City CA, USA: Mind Garden, Inc.
- Bustos, O. (1994). La formación del género: el impacto de la socialización a través de la educación. In CONAPO, *Antología de la sexualidad humana*. México CONAPO-Porrúa.
- Bustos, O. (1991). Género y socialización: Familia, escuela y medio de comunicación. In González Pérez, M.A. and Mendoza-García, J. (Compiladores) *Significados colectivos: procesos y reflexiones teóricas*. Tecnológico de Monterrey/CIIACSO. México.

- Ercikan, K.; McCreith, T. and Lapointe, V. (2005). Factors associated with mathematics achievement and participation in advanced mathematics courses: an examination of gender differences from an international perspective. *School Science and Mathematics* v105 n1 p5.
- Fierros, E. G. (1999). *Examining Gender Differences in Mathematics Achievement on the Third International Mathematics and Science Study (TIMSS)*.
- Gomariz Moraga E. (1992). Los estudios de género y sus fuentes epistemológicas; periodización y perspectivas. Serie: *Estudios Sociales* No. 38, FLACSO, Santiago, pp. 1-17.
- Johnson, R. M. (2000). *Gender Differences in Mathematics Performance: Walberg's Educational Productivity Model and the NELS:88 Database*.
- Lamas, M. (1986). La antropología feminista y la categoría de género. En: Nueva Antropología. *Estudios sobre la mujer, problemas teóricos*. NAH. *Revista de Ciencias Sociales*. Vol. VII, No. 30. GV Editores. México. pp. 173-198.
- Leahey, E. and Guo, G. (2001). Differences in Mathematical Trajectories. *Social Forces*, v80 n2 p713-32.
- Leder, G.C. (1992). Mathematics and Gender: Changing perspectives. Grows, D. A. (Ed.), *Handbook of Research on Mathematics Teaching and Learning*, USA: National Council of Teachers of Mathematics, pp. 597-622.
- Scott, J. (1986). Gender useful category of historical analysis. *American Historical Review*. 91.
- Spence J., Helmreich, R. and Holahan, C. (1979). Negative and positive components of psychological masculinity and femininity and their relationships to self-reports of neurotic and acting out behaviors. *Journal of Personality and Social Psychology*, 37, 1673-1682.
- Zhang, L. and Manon, J. (2000). *Gender and Achievement--Understanding Gender Differences and Similarities in Mathematics Assessment*.

\* This study was carried out with a grant from the Ministry of Education (SEP) and the National Council for Science and Technology (CONACYT), through Fondo Sectorial de Investigación para la Educación. Project number: SEPSEByN-2003-CO1-22.



# SELF ASSESSMENT AND APPROPRIATION OF ASSESSMENT CRITERIA

Leonor Santos and Anabela Gomes

Lisbon University; School of Education of Setúbal

*This article focuses on the evolution of students' ability for self-assessment. Although the student studied shown an evolution, knowledge of the assessment criteria is not enough to contribute to improve her performance. Self-representations of the criteria led to gaps between what the student did and what was aimed by the criteria. The conflict required to change the representations depends on a continuous investment by the teacher.*

## INTRODUCTION

Over the years, the emphasis on understanding assessment as part of the learning process has gained strength (Crockcroft, 1982; NCTM, 1989; NCTM, 1995; NCTM, 2000). The monitoring and self-monitoring dimensions of assessment have especially singled out. In essence, every individual performs self-assessment (Nunziati, 1990) and this ability may contribute to the self-construction of a trajectory that allows him/her to overcome obstacles. Self-assessment is associated to the comparison between what one achieves and what one thinks should be achieved. However, the valued criteria, though explicit, do not necessarily have the same meaning for all those to whom they are presented (Morgan, 2003). Meanings may depend of each one's perspectives, namely as regards assessment, the subject and its teaching. So it is important to understand how students mobilize assessment criteria, the difficulties they encounter in constructing their meanings, and how the discrepancy between different interpretations can be minimized.

This paper concerns a larger study whose main aim was to understand how students' ability for self-assessment develops when the teacher invests in the appropriation of assessment criteria, in the context of the classroom. In this context, where students engaged in problem-solving, in research activities and in writing up reports about their work, we sought to understand (i) in what way students use the assessment criteria adopted throughout their activity, and (ii) the difficulties students have in their appropriation.

## THEORETICAL FRAMEWORK

Viewing mathematics as a creative activity must be accentuated in school mathematics. Students should engage in problem-solving, in research activities and in the construction of mathematical argumentation (NCTM, 200, 2003). But these tasks, per se, are not enough for students to develop their own knowledge about thinking mathematically. Students need to develop a conscious, reflective practice, of which

the development of self-assessment is a part. To do so, they must establish a comparison between what they do and the criteria that are valued. For instance, students should know what is sufficient to correspond to a proposal and understand what is meant by a plausible mathematical justification (Yackel & Cobb, 1996).

According to the NCTM (2003), self-assessment methods comprise teaching students to understand the objectives of learning and the assessment criteria, as well as resorting to tasks that allow them to assess their own learning processes. Involving students in self-assessment requires that they know and understand the assessment criteria (Jorro, 2000; NCTM, 2003; Perrenoud, 1998; Santos, 2002). Fully clarifying the criteria does not imply appropriating the assessment language (Morgan; 2003). The appropriation of assessment criteria, even though clearly defined, varies from individual to individual. This appropriation specifically implies a shared construction of meanings between teacher and students that promotes an alignment between the interpretation of the students and those of the teacher. For this to occur, the teacher should consider other, complementary strategies besides the clarification of criteria (Santos, 2002). Also, the use of criteria depends partly on the individual's level of acceptance and internalization of objectives, standards or criteria.

Self-assessment is a competency that is worth constructing, for moving from a spontaneous assessment to an intentional control system regarding one's performances results from a learning process (Nunziati, 1990). To Hadji (1997), self-assessment is an activity of reflected self-control over actions and behaviour on behalf of the individual who is learning. Santos (2002) stresses that self-assessment implies that one becomes aware of the different moments and aspects of his/her cognitive activity, therefore it is a meta-cognitive process. A non-conscious self-control action is a tacit, spontaneous activity that is natural in the activity of any individual (Nunziati, 1990), and in this sense all human beings self-assess themselves. Meta-cognition goes beyond non-conscious self-control, for it is conscious and reflective (Nunziati, 1990),

## **METHODS**

The methodology used was qualitative and interpretative in nature (Goetz & LeCompte, 1984), because of its adequacy to understand these problems within teaching and the fact that the features of this kind of methodology were in keeping with those of the options in the present study (Bogdan & Biklen, 1982). The research design followed was the case study<sup>1</sup>.

The tools for collecting data were participant observation, interviews and the documental analysis of the written productions of students (reports and self-assessments). 23 lessons of a 7th grade class (12-year-old students) were monitored during the 2003/2004 school year. In the first class the study was explained to the students, as were the general criteria of assessment. Six classes were devoted to

---

<sup>1</sup> Although two case studies were developed in this study, in this paper only one will be addressed.

getting them used to the presence of the researcher and to getting to know the students better. Finally, what had been agreed between the researcher and the class teacher was developed over 16 classes, with a view to developing the students' self-assessment ability. These classes were audio and video-taped and fully transcribed. Four semi-structured interviews took place with each case student and were also fully transcribed. The students did reports about the activity that was developed and their respective self-assessments. The data were subjected to several levels of analysis that took place periodically (Miles & Huberman, 1994), based on categories defined a posteriori that arose from the data gathered and keeping in mind the theoretical framework and the questions of the study.

Throughout the whole year the researcher and class teacher developed collaborative work that included working sessions for planning classes, defining tasks for the students (three problems and two tasks of mathematics research), the creation and reformulation of assessment criteria, analysis of the students' reports and self-assessments and the definition of strategies to facilitate the students' appropriation of the criteria. The assessment criteria considered were: *Presentation of the report; Task solving strategies; Explanation of the way you thought; Reflection about strategies and solutions; Mathematical language*. The facilitating strategies for appropriating assessment criteria included their full clarification, confronting the students with these criteria, the opportunity to improve work, the adoption of a group work methodology (co-assessment between peers), the request of students self-assessments (self-assessment and co-assessment) and writing up feedbacks.

## THE CASE OF VANDA

Vanda is a 12-year-old student who participates in class, but usually she is not one of the first to intervene. She communicates well and generally takes care with the language she uses. She attributes the fact that she had a 5<sup>2</sup> in Mathematics the previous year to her effort: "because I think I worked hard to deserve it". She associates Mathematics to numbers and arithmetic above all, and states that Mathematics helps "our daily life when we're dealing with bills, even when we go to the shops to know what we have to pay". Vanda declares that she likes Mathematics because "it's... interesting, it's different, it's novel". Vanda studies Mathematics by solving exercises in various books, although she also studies the notes she takes in classes: "I solve a few exercises (...) I also study with my notes, sometimes even with the textbooks, but more with activity books". This student relates assessment to teachers' objectives and the final mark to those of the tests. As for self-assessment, Vanda strongly connects it to the end-of-term mark. She is used to self-assessing, especially at the end of term. She does so expressing herself in terms of levels.

In the first task developed within this study, Vanda's self-assessment was very different from the teacher's. The improved version of her report, though carefully and

<sup>2</sup> In a scale of 1 to 5, where 5 is the maximum level of performance.

creatively presented, resorting to an A3 card, simply includes one successful attempt and one lost, for each list of numbers, with very superficial reflections. In the first interview, Vanda finds the following aspects those that teachers most value: “presentation, the words used, the expressions, (...) where we provided that information, which topics we addressed”. So, at the start of the study, she values the report presentation and development most of all because she feels that is where the solution of the task is, that is, the answers to the questions posed.

In the second task, the teacher once again stresses the need for the students to record what they discuss. Although the discussion between Vanda and the colleague sitting beside her took a whole class and involved calling the teacher several times to validate their reasoning, in the report they only present their conclusions without explaining them more thoroughly. The aesthetic side of their work is still the most favored aspect. In fact, these students even wrote titles on the computer to then paste on their work, despite the teacher having explained that embellishing it was not important (“what we want here isn’t pretty work”), and that Vanda had replied: “Well-organized work”. Vanda emphasized the “well-organized” of her comment and the teacher had continued to explain: “It can have things that are crossed out. As if this was the road we were taking and we gave up because we felt it wasn’t the best way”. But Vanda continues to associate this aspect to the appearance, “it’s lovely with the colors”, and to the sequence of ideas that show the answer, but not necessarily to its mathematical grounding. Neither student writes anything down as to the difficulties they felt. In the part of the conclusion and reflection of the report they write: “We enjoyed developing this task because it helped us to develop knowledge and work better in group”.

As the different learning experiences progress, Vanda begins to question her explanation of the reasoning she develops and to distinguish the strategies she used for the calculations. In the interview that took place after the fourth task, when commenting on the criterion *Explanation of the way you thought*, Vanda states: “I think there are things we could have put better because there were parts that perhaps we could have explained more (...) the explanations could have been clearer”. The *Reflection about strategies*, to Vanda, is “reaching a conclusion and explaining with my way of thinking. Now that’s what I think is showing we reflect”. Thus this student now sees reflecting about the task as one of the parts to include at the end of the report, as the synthesis of the entire work, and associates to it a reflection about everything they did.

In the last task, Vanda starts with the introduction, moves on to the development, and then the conclusion. She does the cover after finishing the work. Also, she does no previous draft, nor does she make a fuss about crossing out what she wants to annul. This time, she does not eliminate part of her research from the report just because she decided to go another way. Despite not having commented on her first approach, her intention was to show the route she took.

In the first criterion she feels she respected much of the proposed structure and explains that, as regards the *Presentation of the report*, “it’s really everything, cover

and all, I think the whole report's important, every single sheet, not just the cover, but the presentation of the cover's also important and so is presenting the whole report". So although Vanda still favours the development, and then the conclusion of the task, she refers that she must present every part of the structure. She also finally stops investing mainly in the aesthetic appearance of the report.

As for the *Solving strategies*, she states she presented these fully. She feels she explained the way she thought. For Vanda, presenting solving strategies for a problem and explaining the way she thought are not one and the same:

Well, you can just stick a strategy there, can't you? If you can use an expression, but how does it get there, right? There's got to be an explanation as to how it got there, that I did it, I reached that conclusion.

Vanda still seems to think that if she presents the calculations, or a table, for example, the strategy is there. But she knows she has to include the intention and the connection to what she intends to do, and what she makes of it. She explains that she chose the implementation level 3<sup>3</sup> for the criterion *Task solving strategies* precisely because she thinks that although she tried to meet its requisites, she could have presented her strategies in a "more complete" way. And she clarifies this statement: "I think I could have a more complete explanation of how it got there, how I did that". As such, she considers she only reached the implementation level 3 for the criterion *Explanation of the way you thought*.

In the following criterion she claims to have reflected about strategies and solutions. For her, in Mathematics it is important to reflect about the strategies used and solutions reached, but she still focuses her justification on her reflection about strategies: "yes, because we've got to put a strategy there, and the strategy might be wrong, and we have to reflect, see which conclusion we draw". So Vanda reflects about the strategy to see which conclusion she reaches and to see if the former is wrong. However, she continues not to regard cases where the strategy was right and the answer would have to be in clear consistency with her analysis. Vanda states that the teacher can verify a student's reflection about strategies and solutions, in the report, precisely from the explanations and the "steps" the student took: "ah..., because of the explanations that are there, see, the steps we took". But in her final interview she justifies having chose implementation level 3 in the criterion *Reflecting about strategies* and solutions with the fact that she did not manage to explain why her conjecture (solution) turned up.

To this student, the adequate use of mathematical language, showing a sound knowledge of the relations between expressions and knowledge, implementation level 4 of the last assessment criterion, is "to use the expressions as well, see, to use the content with the right expressions", that is, to resort to the content and mobilize the right expressions in her explanations and definition of her "steps". Vanda chose

<sup>3</sup> In a scale of 1 to 4, where 4 is the maximum level of performance.

level 3 in the criterion *Mathematical language* because she feels she did not mobilize her knowledge well enough: “I didn’t find a justification, the evidence, probably because I didn’t mobilize the content or the knowledge”.

Finally, it should be noted that Vanda attributes implementation level 3 for the first time to all the assessment criteria in the only task she solved individually. The fact that she worked on it alone may have left her more insecure as to the quality of her performance, an aspect that may have influenced her judgments about the quality of her work. However, given that Vanda effectively integrates more aspects of the criteria than she did initially, choosing this level seems to be related to a more critical look at her report.

## CONCLUSIONS

While solving tasks, Vanda mobilizes self-representations of the criteria and other standards that steer her activity; in other words, she resorts to a spontaneous form of assessment (Nunziati, 1990). Initially her stance towards her activity is almost as if the expressed assessment criteria did not exist. She is used to self-assessing herself but only in the final balance performed at the end of each term which, according to Abretch (1991), does not have the desired effects in a formative assessment. As Vanda realizes the importance of the criteria in her assessment, she seeks ways to try and correspond to her understanding of each criterion. In the second task Vanda actually does put down more than the calculations so as to respond to the proposal, but the explanations of certain choices and of one of the conclusions remain only implicit, and one of the conclusions is not clear. She maintains her own personal idea of what she thinks is valued (“well-organized work”), continuing to place aesthetic appearance above a good part of the rest, until she does the third task, in which there is a direct interaction with the teacher about this matter. Up until the fourth task she develops no justifications beyond a few examples, calculations or the adoption of forms of representing data.

From the start of the study, Vanda associates the thing that allows her to reach conclusions to the criterion *Task solving strategies*, which in practical terms means calculations or a table. At the end of the study, she has not totally modified this perspective, but shows she is aware that it is not enough to present only calculations or a table – she must associate to these an “explanation” for the reason they appear in her work, for how it was conducted and for drawing a conclusion from this. Vanda first understood the *Explanation of the way you thought* as the presentation of calculations and opinions. By the end, she actually considers more justifications than those she carries out and grounds one of her conclusions mathematically. As for the criterion *Reflection about strategies and solutions*, Vanda simply related it to strategies. The explanations she elaborated in her solutions assume some relevance in light of this criterion and this evolution is clear in her self-assessment regarding the final task. But ultimately it seems that the main thing that keeps marking this criterion for Vanda is that reflecting about the strategy is all it takes for solutions to

arise naturally. Initially, Vanda associated the criterion *Mathematical language* to the knowledge of the content involved. At the end of the study, she relates this criterion to both knowledge and the expressions used.

Vanda's main difficulties in appropriating assessment criteria are related, first and foremost, to not being used to working with them. At the beginning she is directed by an impression she creates of the work before her, based on self-imposed standards. Later, when developing her learning, Vanda becomes aware of the aspects that are really valued. The interpretation she develops in light of the criteria is influenced by the importance of what she considers to be a correct answer and of what she thinks is a plausible justification. However, this student keeps seeking forms of trying to correspond to the criteria. And despite not changing some of her perspectives, Vanda realizes what she must present in order to draw closer to what the teacher values. As regards self-assessment (final balance) of the report, it also becomes increasingly self-critical.

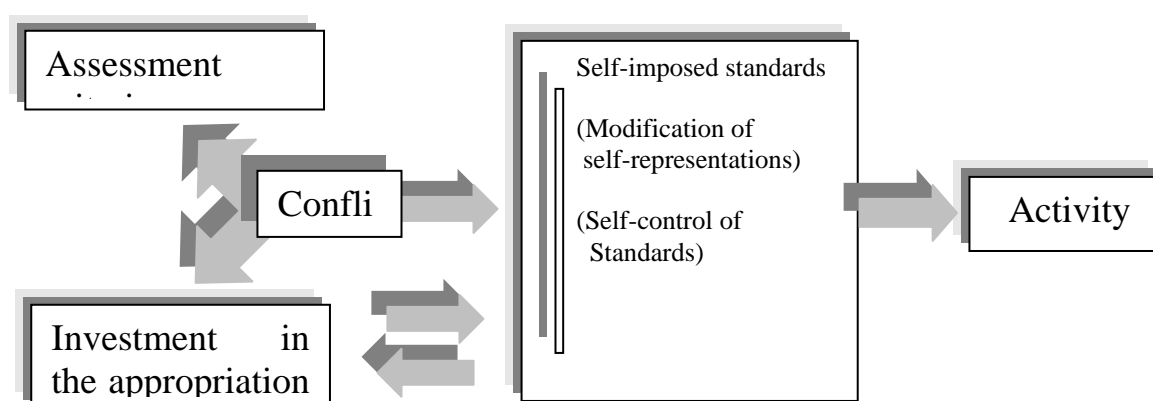

Figure 1. Interrelations between factors intervening in students' activity

In short, self-imposed standards that derive from their experience of assessment may be said to mediate students' actions towards the criteria and the activity under development (see fig. 1). In this study, the conflict required to change representation or to control the standards created by students was motivated by the teacher's investment in appropriating criteria. Standards are questioned through this investment. From this conflict new representations or the self-control of initial standards arise. In other words, the relationship between assessment criteria and self-imposed standards changes, both through adjustments and through the management of what is done, controlling that which is self-valued. This has reflections on students' activity.

## References

- Abrecht, R. (1991). *L'évaluation formative. Une analyse critique*. Bruxelles: De Boeck.
- Bogdan, R. & Biklen, S. (1982). *Qualitative research for education: An introduction to theory and practice*. Boston: Allyn and Bacon, Inc.
- Crockcroft, W. H. (1982). *Mathematics counts*. London: HMSO.

Hadji, C. (1997). *L'évaluation démystifiée*. Paris: ESF Éditeur.

Goetz, J. & LeCompte, M. (1984). *Ethnography and qualitative design in educational research*. New York: Academic Press.

Jorro, A. (2000). *L'enseignant et l'évaluation*. Bruxelles: Éditions De Boeck Université.

Miles, M. B. & Huberman, M. (1994). Data management and analysis methods. In K. D. Denzin & Y. S. Lincoln (Eds.), *Handbook of Qualitative Research* (pp. 428-444). California: SAGE.

Morgan, C. (2003). Criteria for authentic assessment of mathematics. Understanding success, failure and inequality. *Quadrante*, 12(I), 37-51.

NCTM (1989). *Curriculum and evaluation standards for school mathematics*. Reston, Virginia: NCTM.

NCTM (1995). *Assessment standards for school mathematics*. Reston, Virginia: NCTM.

NCTM (2000). *Principles and standards for school mathematics*. Reston, Virginia: NCTM.

NCTM (2003). *A research companion to principles and standards for school mathematics*. Reston, Virginia: NCTM.

Nunziati, G. (1990). Pour construire un dispositif d'évaluation formatrice. *Cahiers Pédagogiques*, 280, 47-62.

Perrenoud, P. (1998). *L'évaluation des élèves: de la fabrication de l'excellence à la régulation des apprentissages. Entre deux logiques*. Bruxelles: Éditions De Boeck Université.

Santos, L. (2002). A auto-avaliação regulada: porquê, o quê e como? In P. Abrantes & F. Araújo (Eds.), *Avaliação das aprendizagens* (pp. 75-84). Lisboa: ME, DEB.

Yackel, E. & Cobb, P. (1996). Sociomathematical norms, argumentation and autonomy in mathematics. *Journal for Research in Mathematics Education*, 27(4), 458-477.



# DRAWING AS PROBLEM-SOLVING: YOUNG CHILDREN'S MATHEMATICAL REASONING THROUGH PICTURES

Carole Saundry and Cynthia Nicol

University of British Columbia, Canada

*Our project investigates how young children think through mathematical problem-solving. The project examines how children respond when presented with a mathematical problem to solve, the kinds of pictures they draw spontaneously, the things they are thinking while they draw, and how teachers can support children in developing these skills in order to become better mathematical problem-solvers. Video footage and student work informs the creation of a framework for examining students' drawing as problem-solving and provide a lens for understanding children's mathematical reasoning as expressed through and derived from pictures.*

## RATIONALE

Mathematical problem solving involves a series of complex processes – identifying the problem, interpreting what is to be done, selecting and applying a strategy for solving the problem and then assessing the reasonableness of the solution. Teachers seek to support their students, particularly in the selecting and applying of strategies for problem solving, by offering a range of possible methods. Often this list of problem-solving strategies includes “draw a picture”.

Some children draw elaborate pictures for even the simplest of problems, representing their final solution in detailed, pictorial form. Students who focus on drawing the surface elements of problem (like the eyelashes of the people sharing the seats on the bus) might miss the mathematical point of the problem.

Other children use drawing in an entirely different way – with a different purpose and outcome. These children employ drawing “as” problem solving. For these children, the act of drawing is both a process and a product. In this case, drawing – or representing – is done during problem solving. For these children, mathematical representations, by virtue of their use as supports for thinking processes, are more iconic – representative of an idea, a numerical process or a mathematical concept.

Our project examines a child’s production of an image in response to a mathematical problem, and the nature and purpose of what children represent while they solve problems. This study focuses on drawing “as” problem solving, and through observation of a series of performance tasks with young children, outlines a framework for describing student’s representational thinking.

## CURRENT RESEARCH

Wheatley and others (Cobb, Reynolds, Presmeg, Steffe; Thomas, Mulligan, and Goldin, 2002; Gray, Pitta, and Tall, 1999) have researched spatial sense and mental imagery, and have posited a connection between a child's capacity to make a mental image and his or her ability to solve mathematical problems. The ability to make and manipulate a mental image is seen to be key in problem-solving, leading a child to think more flexibly in response to a problem. Wheatley and Cobb state that

“[m]athematical problem solving is often a matter of reasoning analytically, constructing an image, using the image to support additional conceptual reasoning... a process of building from images to analysis and analysis to images [that] may continue through many cycles.” (1990, p. 161)

Researchers present varying perspectives on drawing in math class. Some maintain that drawing supports children in modeling a problem and therefore in arriving at a solution for it (Smith, 2003, Woleck, 2001). Woleck (2001) writes from a classroom-teacher/researcher perspective in her attempts to listen to her students' mathematical drawings. She describes her Grade 1 students' drawings in response to math problems and explains that these dynamic representations signify an essential cognitive bridge between the concrete and the abstract in mathematics. As children strip away the unnecessary features of a problem, removing all but the essential elements of the problem's structure, they become generalizable to more than the single context in which they are being used.

Smith's (2003) study of third graders' drawing while problem-solving, he noted that each child drew – both to manipulate the objects in the problem (drawing as problem-solving) and to represent their thinking afterwards (drawing of problem-solving). He noted that the children's use of drawings differed in terms of their idiosyncratic nature in relation to the problem context. Smith concluded that the artifacts children produce in solving mathematical problems – including language, drawings and constructions – cannot be considered separate from the students' mathematical reasoning.

Current Cyprian research focuses on the interpretation of an image and the degree to which the image supports or detracts from a child's capacity to problem-solve (Elia & Philippou, 2004). Focused largely on intermediate aged-children's interpretations of images, these researchers did not ask students to solve mathematical problems by drawing, but rather by reading information presented pictorially. In terms of image production, results indicated that intermediate-aged children were taught to use very specific schema for representing mathematical operations; however, the research did not address a child's spontaneous and constructed representations or the development of these images over time and with experience.

## CONTEXT OF THE STUDY

Research in the area of young children's sense-making through the act of drawing is just developing. While there is acknowledgement that drawings assist children in

representing their mathematical thinking and that this form of representation has merit (Smith, 2003), there is little research focused on how representational capacity develops in young children, or what thinking transpires while drawing. Clearly, talk is central to understanding a child's internal representational capacity; this study uses an interview format to clarify and expand on what a child is thinking while he or she draws, and how the process of representing a problem supports the problem-solving process.

Several questions are raised: How do children represent actions (like sharing, joining or separating) in pictures? How do these paper-pencil images match what children see in their heads? How complex does a problem have to be before a child's internal representations must be supported by external ones?

## **RESEARCH METHODS**

The participants for this study were 34 Grade 2 students from a suburban school district. An initial set of problems was given to all grade 2 students in small groups of 4-5 children at a time. This whole class data served two purposes – as a screen for potential individual participants, and as artifacts to inform the generation of a framework for considering drawing as problem-solving capacity. Following on from this whole-group experience, six individuals were selected for further in-depth interviews. The assessment of “picture use as a thinking scaffold” took place in a one-on-one interview format. Students in both settings were video-taped, both from above and using a hand-held camera to capture both the talk and the act of drawing as it happened.

Problems were both routine and non-routine in nature. Students were asked to solve a range of problems: a grouping and a sharing problem (e.g. 18 cookies. 12 children share. How many will each child get?) as well as a combination and two-step problem involving more than one operation (e.g. 18 wheels, how many toys could there be?). Children were presented with a piece of paper and a pencil, and the problems were read aloud to the students.

During the course of the child's problem-solving, the following metacognitive questions were asked: “Can you tell me what you're thinking? How do you know? What does this part of your drawing mean?” After the problems are completed, specific questions around the act of drawing were asked, including: “How did drawing help you think about the problem? How did drawing help you solve the problem?”

## **DATA ANALYSIS:**

Data analysis involved repeated watchings of the video footage - both the footage gathered on the overhead stationary camera and that from the handheld camera used for close-ups. These two vantage points proved invaluable in the assessment of the students' processing of the problems through visualization. Careful observation of the footage of children working revealed a range of common responses to the problems

presented. Each response type (using a picture as a counter, using a drawing to keep track of or eliminate items) children's image-making efforts (lifting eyes up, thinking aloud about the pictures in their heads), and the degree of sophistication of the drawing itself (elaborate pictures, or more iconic representations) were annotated along with the time at which they occurred. In all, there were 15 different types of responses to the problems noted; as subsequent video was viewed and re-viewed, these 15 were grouped into four categories or drawing as problem-solving themes, namely: virtual manipulatives, systems, imagery and sophistication.

Students' comments - the questions they asked, their meta-cognitive talk, their interactions with other children - were transcribed verbatim. A further language sample was recorded when children were asked how drawing helped them solve the problem. These answers helped to clarify what students were thinking while they drew and the degree to which drawing was seen as helpful.

## **RESULTS**

Video data of grade 2 students' processing of the sharing problem provided multiple indicators of drawing as problem-solving. Key themes emerged upon analysis of both the footage and the students' work in progress.

The use of pictures as manipulatives: Some children used their drawings as a kind of manipulative or counter. They manipulated their recorded images on the page, moved, eliminated, shared or divided pictures as a way of solving the sharing problem. Like using physical manipulatives, this particular use of pictures required movement; students represented the action of sharing of cookies or the grouping of wheels with lines, arrows or circles, and counted their representations as they would have if they had used physical counters.

Pictures as system support: For some, pictures or other iconic representations provided students with a scaffold for keeping track of the elements of the problem - a system for eliminating or distributing items, a way to systematically test possible solutions. For the sharing problem, (18 cookies, 12 kids), students using their pictures in this systematic way drew 18 cookies on one side of the page, and then people on the other side, crossing out cookies that they had "given away". In this way, children could apply a process of elimination. The picture itself was critical to keeping track of the elements of the problem, and children using their drawings in this way would often count, recount and check their partial solutions.

Sophistication of representation: The degree of sophistication of student drawings varied greatly; while some drew elaborate, artistic pictures, still others used simple iconic representations. While some children lost mathematical direction by focusing too heavily on elaborately detailed pictures of people and cookies, still others processed the mathematics through the act of drawing the "story" or problem situation. One child put himself right into the cookie-sharing situation and drew his own portion of the 18 cookies on a plate. His picture allowed him to represent - and really understand - his response of "we all get one cookie and a half of a cookie".

Imagery: Still other students did not draw a picture immediately, or even at all. On initial viewing of the hand-held video footage in which the camera's lens was focussed on pencil and paper, it appeared by their lack of drawing as though these students were confused by the problem or did not have a strategy for recording their ideas. Once the overhead camera footage was viewed, however, it was clear that these students were using a different kind of strategy for processing the problem: visualization. From a vantage point overhead, it was observed that these children spent time looking up and thinking, their eyes moving as though watching a movie in their heads. Several of these children recorded their solution to the problem by printing only a numerical answer on the page. One child spent more than 10 minutes without putting pencil to paper, eyes up and muttering to himself, then wrote "3 halves" on his page. When asked how he had come up with the answer three halves, he stated simply that "it just came into my head". Without drawing, this child had still processed the information in the problem in a visual way.

Within each of these broad themes, individual indicators were recorded and analyzed by task and by working group in order to examine trends in the kind and type of drawing as problem-solving behaviors. Many children used more than one type of strategy for approaching the problem, moving from virtual manipulatives to visualization and then to the adoption of a system for processing the information. The most successful children in the solution of the problem were those who adopted and implemented a system (elimination, check and re-check), regardless of the sophistication of their drawing - or whether they drew at all.

### **Contribution to a current body of research**

Some researchers seek to support students by moving beyond their constructed idiosyncratic drawings to more structured and formal representations. Novick, Hurley and Francis (1999) have defined 4 general-purpose diagrams that can be used to match the structure of any given problem; Diezmann and English (2001) describe ways that teachers can support their students in understanding the relationship between a problem and the diagram needed (2001, p. 86-87). Diezmann and English promote diagram literacy – “the ability to understand and use and to think and learn in terms of images” in their study of 10 year old mathematics students (p. 77). The authors’ desire to connect image-making and mathematical understanding is consistent with the work of Wheatley, Cobb and Yackel. An important distinction is the application of Diezmann’s research findings. While Diezmann and English highlight the importance of talk and modeling when working with diagrams, they also recommend that students be explicitly taught these four specific diagrams and when to apply them, and should practice them within structured problem sets. They maintain that students should be presented with sets of problems that can be represented with a particular diagram and that the relationship between a problem and its corresponding diagram should be explicitly taught. Although the participants in the Diezmann study are 10 years old and approaching a developmental stage at which these relationships could be introduced and discussed, caution must be exercised when accelerating this developmental process for younger students. The desire to

support diagram literacy (Nickerson, 1994) in elementary school-aged students should not supercede the natural development and constructed meaning-making for young children promoted by the NCTM and researchers like Woleck and Smith. Smith acknowledges that children need to bridge from idiosyncratic to mathematical representations in order to understand and communicate mathematics (p.273) but makes the case for sharing, discussing and analyzing peers' solutions as a developmentally appropriate way to bridge from one to the another.

## CONCLUSION

To support teachers in understanding how it is that the act of drawing assists their students in problem-solving, and how drawing as problem-solving is often complemented by visualization, a framework for describing the indicators of thought through representation is needed. Providing early primary educators with ways to interpret students' performance when drawing to solve a problem will give them a tool to support their children in moving along the continuum. Exploring drawing as problem-solving may help teachers recognize and lend credibility to children's earliest representations, and help them to notice the process of problem-solving and not simply the product.

Research in the area of young children's drawing as problem solving is limited. The hope is that this study might contribute to a larger body of research related to the representation of mathematical thinking, and to fill a gap in considering how the process of drawing – not simply its product – has a central role to play in fostering children's mathematical reasoning. Our project seeks to address key questions related to this topic: complexity, problem-types, the relationship between problem language and student action, and by identifying observable indicators of mathematical reasoning while children are engaged in drawing, to contribute to the field of mathematical representation.

## References

- Diezmann, C. M. & English, L.D. (2001). Promoting the use of diagrams as tools for thinking. In A Couco (Ed.) *The roles of representation in school mathematics*. (pp. 215-227) Reston, VA: NCTM.
- Gray, E., Pitta, D., & Tall, D. (1999, in press). *Objects, actions and images: A perspective on early number development*. Adapted version of a paper presented to the Elementary Number Research Forum of the XXI International Conference of the Group for the Psychology of Mathematics Education, Lahti, Finland.
- Elia, I., & Philippou, G. (2004). The functions of pictures in problem-solving. In Johnsen Høines and Fuglestad (Eds) *Proceedings of the 28<sup>th</sup> Conference of the International Group for the Psychology of Mathematics Education, Volume 2*. pp. 327-335.
- Nickerson, R. S. (1994). The teaching of thinking and problem-solving. (pp. 409-449) In Sterberg, (Ed.) *Thinking and Problem Solving*. San Diego, CA: Academic Press.
- Novick, L. R., Hurley, S. M. and Francis, M. D. (1999). Evidence for abstract, schematic knowledge of three spatial diagram representations. *Memory and Cognition* 27: 288-308.

- Smith, S.P. (2003). Representation in school mathematics: Children's representations of problems. In Kilpatrick, J., Martin, W.G., & Schifter, Deborah (Eds.) *A Research Companion to Principles and Standards for School Mathematics*, (pp. 263-274). Reston, VA: NCTM.
- Thomas, N. D., Mulligan, J.T., & Goldin, G.A. (2002). Children's representation and structural development of the counting sequence 1-100. *Journal of Mathematical Behavior*, 21, 117-133.
- Wheatley, G. H. & Cobb, P. (1990). Analysis of young children's spatial constructions. In L. Steffe & T. Wood (Eds.) *Transforming Children's Mathematics Education: An International Perspective*. (pp. 161-173). Hillside, NJ: Erlbaum.
- Woleck, K. R., (2001). Listen to their pictures: An investigation of children's mathematical drawings. In A Couco (Ed.) *The roles of representation in school mathematics*. (pp. 215-227) Reston, VA: NCTM.





# THE ROLE OF THE TEACHER IN TURNING CLAIMS TO ARGUMENTS

Baruch Schwarz

The Hebrew  
University

Rina Hershkowitz

The Weizmann  
Institute

Shirly Azmon

The Hebrew  
University

*This study concerns teachers' actions and roles while interacting with students in knowledge construction activities. We aimed at tracing how teachers led discussions with students, how they triggered explanations and how they helped integrating them in coherent arguments. We identified some patterns in two teachers who taught the same sequence of activities, with the same didactical aims of constructing probability concepts. We show that these patterns were recurrent and characterized the interactions of each teacher. The patterns concerned how teachers trigger explanations and expand them to turn claims to arguments.*

## THEORETICAL FRAMEWORK

Communication processes are an integral part of classroom life. During a classroom discussion, students express their ideas and thoughts through negotiation of meaning among themselves and between them and the teacher. (Voigt, 1994; Cobb & Bauersfeld, 1995; Mercer, 1997) Therefore, school discussion might be a powerful context for learning and practicing new concepts and for reasoning behavior, when the teacher is leading them to accomplish those aims (Wood, 1995; Mercer, 1997).

Vygotsky dealt with the socio-cultural processes that may influence knowledge construction (Vygotsky, 1936/1987). He argued that the development of knowledge is a process through which one learns how to use intellectual tools already developed by society. He emphasized the crucial role of social interactions in this endeavor. The learner is exposed to tools and procedures and especially to the language that the adult uses which structures his/her thought. The learner may imitate adult behavior, eventually internalizing skills that become mental tools. Their use may lead to knowledge construction (Vygotsky, 1936/1987). However, Vygotsky's theory lacks empirical evidence to show how cognitive gains are attained through and subsequent to social interactions.

Research on interactions between teachers and students is quite rich in the school context. Cazden (1973, 1988) observed *social interactions* between teacher and students in classrooms and found typical patterns with a defined structure. The classroom discourse appears to be *asymmetric*, with a tripartite structure, **IRE** (**I**-Initiation, **R**-Response, **E**-Evaluation): The teacher asks questions, students answer, and the teacher evaluates the answer. Cazden findings describe social interactions only, without focusing on the cognitive processes involved in those interactions.

Van Zee (1997) focused on the powerful cognitive process that may be triggered by the questions of the teacher. She analyzed the patterns involved in questions of a

physics teacher dedicated to guide students' thinking during discussions about measurement. She illustrated different kinds of questions such as opening a discussion, engaging students in thinking actively about a topic, and closing a discussion. Mercer (1996, 1997) elaborated an impressive repertory of the various ways (named *guidance strategies*) teachers adopt to guide knowledge construction.

Some recent educational studies on various domains have emphasized the potential of argumentation for cognitive development and learning (Pontecorvo & Girardet, 1993; Krummheuer, 1995; Kuhn, 1991). Cognitive gains result from reaching consensus through argumentative moves. Individuals try to see others' points of view. Some may ask clarifying questions and by doing so, obliging others to turn the argument to understandable as well as sufficiently substantiated.

The classroom context has the potential to practice argumentative moves and patterns as mental tools that individuals may adopt through social interactions, eventually leading to knowledge construction

In addition to the importance of argumentation as a tool for knowledge construction, some mathematical researchers have recognized its usefulness for *analyzing* learning and teaching processes. For example Cobb and colleagues identified sociomathematical norms (Cobb & Bauersfeld 1995; Cobb et al 2001); others could identify knowledge development through *collective argumentation* (Krummheuer, 1995; Stephan & Rasmussen, 2002). Toulmin's (1969) schemes of justification were used to analyze the acquisition of mathematical concepts. Those studies also show the potential of structural Toulminian argumentative structures (warrants, backing, etc.) explicitly used and routinized to foster learning in classrooms. Yackel and Wood used argumentative structures to analyze teachers' actions while teaching mathematical concepts. They looked for regularities and patterns in the ways that teachers and students act (Yackel, 2002; Wood 1995). These were top-down approaches since ready-for-use Toulminian structures were used to describe various roles played by teachers.

In this study we adopt a bottom-up approach: while we seek argumentative structures, we aim at identifying structures that emerge from talk and interactions between the teacher and her students.

## THE STUDY

The study reported here has one general goal – to trace teachers' guidance from an argumentative point of view in classroom talk. The two specific questions that we ask are:

1. Can we discern specific argumentative patterns that characterize (and differentiate) teachers?
2. In what way these patterns influence argumentation processes in students?

## Method

Experimental design. The data has been taken from a research project in which sequences of activities were designed to lead Grade 8 students to learn conceptual knowledge in probability. The unit includes: Written individual pre-tests, 5 activities designed to take 10 lessons, structured as sequences of problem situations in different social contexts (whole classroom discussion, small group collaborative problem solving, and homework), and individual written post-tests.

## Participants

We followed two teachers from two different schools who volunteered to take part in this experiment. Students in both schools were high achievers. Teacher A had taught probability once before; Teacher B taught probability for the first time. The teachers received the same instructions concerning guidance, specifically concerning leading the class discourse and knowledge construction. Each teacher was free to choose social contexts for teaching the unit (individually in homework assignments, in small groups, or in teacher-led discussion with the whole class). We chose here one of the problem situations in which the two teachers led a discussion with the whole class on the same problem. By doing so, comparison between the two teachers was possible.

	<p>Ofra and Ayelet are throwing an arrow to a target.</p> <ol style="list-style-type: none"> <li>The odds for Ofra to hit the target are 0.3. Mark it on the chance bar.</li> <li>The odds for Ayelet to hit the target are 0.5. Mark it on the chance bar.</li> <li>by using the two chance bars for each girl, we draw a square and divide it with use the probability of the girls to hit and miss the target board.</li> <li>Write within each rectangle what the area stands for?</li> <li>What is the area of the square?</li> <li>Write within each rectangle its area.</li> <li>What is the probability for both girls to hit the target?</li> <li>What is the probability that both miss the target board?</li> </ol>
--	--

## Data analysis

The entire lesson for each of the two teachers was video-recorded, transcribed and analyzed. We sought to identify how they helped in constructing knowledge. Therefore, we looked for argumentative patterns of interaction. The building bricks necessary for this purpose are: (a) *claims* – declarations, viewpoints, etc. and (b) *arguments* – claims followed by explanations. We present here one episode to compare the argumentative patterns of interaction for each teacher.

**Argumentative patterns of interaction for Teacher A**

Teacher A gave this problem as homework. In the following lesson the teacher noticed that most of the students did not complete their homework. She decided to go over this activity with the entire class. This episode is demonstrated in the following excerpt:

Argumentative analysis (argumentative moves and structures)	Protocol	Speaker
	O.K. Is there someone who wants to calculate a different area? Please Guy, choose one.	T 46
Claim & Explanation Argument	Actually the area that Ofra hits is 15% Because they are the same size 0.5 and 0.3.	S 47
Elaboration of the explanation	Are you saying that when only Ofra hits, it is easy to calculate, because Ayelet's chance to hit is 0.5 and it's the same chance not to hit? The exercise is the same, so I chose one for which I already know the answer. And what if we want to calculate another area, how can we do that?	T 48
	May I calculate the area when just Ayelet hits?	S 49
claim	It will be 0.7 multiplied by 0.5.	S 51
Encouragement	0.7 times 0.5, From where did you get 0.7?	T 52
Explanation	Only Ayelet won't hit.	S 53
Elaboration of the explanation	If there is 0.3 chance that Ofra hits, what is left is the chance of 0.7 that she won't hit, Do you understand that? There is a 50% chance that Ayelet will hit ...so What is the result?	T 54
Elaboration of the explanation	0.35	S 55
Encouragement	Can someone tell us, without calculating what the result is here?	T 56
Claim	It's also 35%	S 59
Encouragement	Because?	T 60
Explanation	Because it's the same size.	S 61
Evaluation Explanation Encouragement	<b>That's right</b> , it's the same size. Now, how do we check our calculation to be sure that we didn't make a mistake?	T 62
Claim & explanation	$15\% + 15\% + 35\% + 35\% = 100\%$	S 63
Encouragement	Why should the total be 100% when we add our results?	T 64
Explanation	Because our whole is 100%.	S 65

Argument

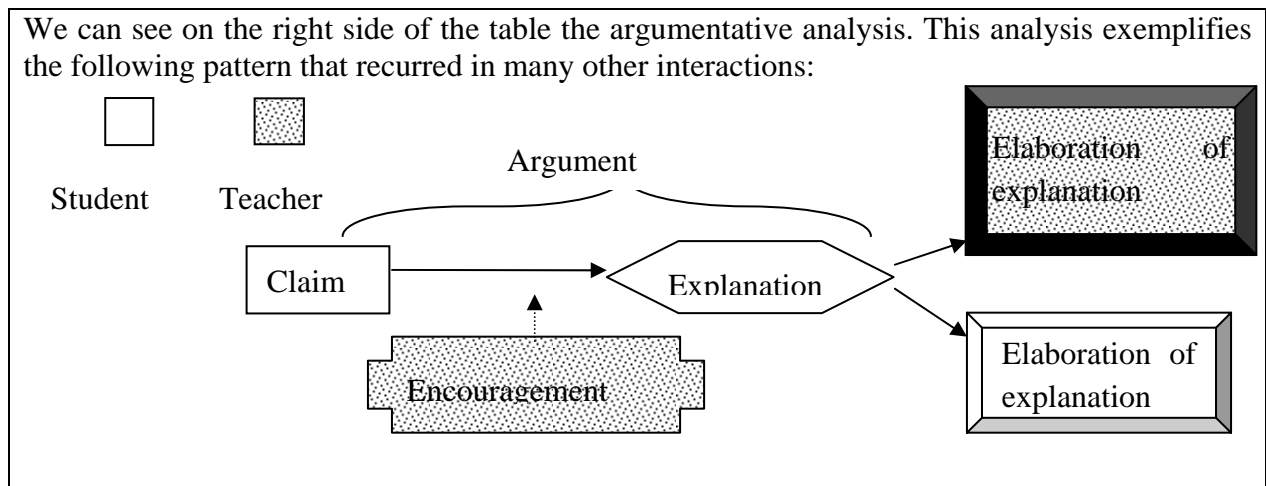

In T46 and T48, teacher A asks her students to engage in knowledge construction and they react accordingly. She elicits their participation (T52, T56, T60, T62, T64). Through her encouragements, she accompanies her students' ways of thinking and by doing so she fosters an argumentative process of knowledge construction. For instance, in the excerpt (T56-S65), teacher A encourages her students to explain why Ayelet's chances to hit are also 0.35. One student expresses the claim "it's also 35%" (S59). The teacher A is not satisfied by the answer and asks for reasons, so she continues eliciting argumentation by questioning: "Because?". The students are probably aware of her expectation to expand the claim and to explain why they expressed this statement, since such a question turned almost into a routine in the class. Then teacher A rephrases answers to challenge their calculation process with a critical question (T62). By saying "15%+15%+35%+35%" they express the calculation process and by adding "=100%" they complete their explanation to the teacher's question. Again the teacher ensures that the argument of the students is reasoned and encourages them to elaborate their explanation (T64), and the students give her an explanation, and leads them to articulate it (S65).

The argumentative analysis uncovers the teacher's mediating role: she encourages students' claims to turn them into arguments (51-55, 59-61, 63-65). In the course of the excerpt, it appears that if a student does not give any explanation, she encourages him/her to do so (T52, T60), and if the explanation does not satisfy her, she elaborates on the explanation (T48, T54), or encourages other students to do so (S55, S65).

This analysis suggests the teacher's belief that the construction of knowledge should be carried out by the students, while her role is to mediate knowledge construction by challenging arguments and encouraging explanations. The pattern displayed graphically above reflects a teaching strategy: she guides her students to raise their own ideas and formulate them as claims, and then encourages them (if they don't do so by themselves) to develop these claims into arguments by providing explanations.

### Argumentative patterns of interaction for Teacher B

Teacher B gave the same problem in the context of small group collaboration. Then she decided to reflect on this task with the entire class during the last ten minutes of the lesson. The protocol of the lesson is as follows:

Argumentative analysis(argumentative moves and structures)	Protocol	Speaker
	Let's go on to Ofra and Ayelet. How do we have to divide the square?	T 335
Claim	To 4!	S 336
Evaluation	<b>That's right;</b> first of all we have to divide into 4 parts. Everyone agrees?	T 337
	Yes!	S 338
Encouragement	What should I write up here? And why?	T 339
Elaboration of the claim	0.3 when she hits and 0.7 when she misses.	S 340
Encouragement	And what about Ayelet?	T 341
Elaboration of the claim	0.5 and 0.5 when she hits and when she misses.	S 342
Encouragement	<b>O.K,</b> So what do you say? What does this rectangle tell us? What is heading? What is the probability?	T 343
Claim	That Ofra misses and Ayelt hits.	S 344
Evaluation	That's right, Ofra misses and Ayelet hits.	T 345
Encouragement	What is the probability to happen?	
Elaboration of the claim	0.35	S 346
Encouragement	And down here? What does the area describe? Yes, Yarden?	T 347
Claim	The probability that both will miss.	S 348
Encouragement	And what is the chance to happen?	T 349
Elaboration of the claim	0.35	S 350
Encouragement	What question does this rectangle answer?	T 351
Claim	I want to answer, Ofra hits and Ayelet does not.	S 352
Evaluation	Ofra hits and Ayelet misses.	T 353
Encouragement	And what is the chance to happen?	
Elaboration of the claim	0.15	S 354
Elaboration of the claim & Encouragement	Also here it is 0.15. Is it the same?	T 355
Elaboration of the claim	No, is a different 0.15.	S 356

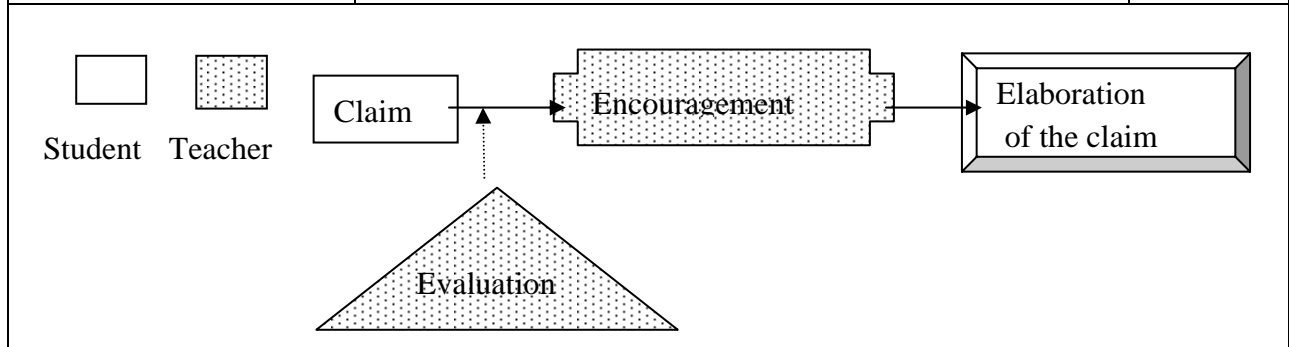

It appears that Teacher B asks very short and closed questions (T335, T339, T343, T345, T347, T349, T351, T353). The students give short answers – claims without explanations (S336, S338, S344, S 346, S350, S354, S356). We called this kind of talk **Socratic talk**, in the sense that the students guess the expectations of the teacher and answer accordingly (it is not Socratic in the sense that the teacher helps articulating implicit, unclear knowledge). The evaluations Teacher B expresses (T337, T343, T345, T353) frame students' answers, and tune the students with the expectations of the teacher (Teacher A evaluate just once). Teacher B triggers and encourages talk in students through short questions, to which students react by very short and superficial answers. When the teacher tries to elicit more elaborated responses (T339, T341, T355), the students are not responsive.

The argumentative analysis shows that the questions of the teacher lead students to express claims but not explanations that would have completed them to arguments (T343-S346). Here also, the argumentative pattern reflects a personal teaching strategy: asking local and closed questions, getting back claims, evaluating those claims and encouraging students to elaborate them. But they do not provide explanations. In fact we suggest that the encouragement is a lip service to pretend that this is the role of the students to provide explanations. She and the students play this game, but all participants are content that the teacher eventually provides the explanations that should have been given by the students.

The two analyses contrast the talk of the two teachers. The contrast is salient from an argumentative point of view: while students discuss probability concepts with teacher A, students express that do not develop to deeper constructs.

## CONCLUDING REMARKS

As stated before, our main goal was to trace how teachers guide knowledge construction in whole class discussions. We could identify argumentative patterns of interaction involving the teacher and students. These patterns were recurrent although we could not demonstrate this recurrence in this short paper. The analyses of additional discussions by different teachers that participated in the experiment show that the patterns characterize teachers. They convey different mathematical norms and classroom cultures: with teacher A, students feel obligated to support claims by explaining; they are used to crystallize ideas by reaching agreement and negotiating mathematical meanings; with teacher B, students are committed to tune to the teacher's questions and to adopt her explanation as theirs. We could discern other variants of patterns that convey different mathematical and epistemological norms.

An exciting research direction we currently pursue concerns linking argumentative patterns of interaction and students' further behaviors in successive activities (including small group and individual activities). Although the students who interacted with teacher A seem to have had more opportunities to construct meaningful knowledge through the argumentative tools, their internalization is subject to complex factors. For example, the autonomy given to students with teacher A may impair the acquisition of scientific knowledge, as compared with the

authoritative patterns presented by teacher B that give more confidence that a certain kind of explanations and arguments is usable further on. These are certainly very interesting considerations we try to cope with in our current research efforts.

## References

- Cazden, B. C. (1988). *Classroom discourse: The language of teaching and learning*. Portsmouth, NH: Heinemann.
- Cobb, P. & Bauersfeld, H. (1995). *The emergence of mathematical meaning: interaction in classroom cultures*. Hillsdale, New Jersey.
- Krummheuer, G. (1995). The ethnography of argumentation. In P. Cobb & H. Bauersfeld (Eds.), *The emergence of mathematical meaning* (pp. 229-269). Hillsdale, New Jersey.
- Kuhn, D. (1993). Science as Argument: Implications for Teaching and Learning Scientific Thinking. *Science Education*, 77(3), 319-337.
- Mercer, N. (1997). *The guided Construction of knowledge: Talk amongst teachers and learners*. Clevedon. Philadelphia. Adelaida.
- Pontecorvo C. & Girardet, H. (1993). Arguing and reasoning in understanding historical topics. *Cognition and instruction* 11(3&4), 365-395.
- Stephan, M. & Rasmussen, C. (2002). Classroom mathematical practices in differential equations. *Journal of Mathematical Behavior*, 21, 459-490.
- Toulmin, S. (1969). *The uses of argument*. Cambridge, UK: Cambridge University Press.
- Van Zee, E. & Minstrel, J. (1997). Using questioning to guide students thinking. *The Journal of the Learning Sciences*, 6(2), 227-269.
- Voigt, J. (1994). Negotiation of mathematical meaning and learning mathematics. *Educational Studies in Mathematics*, 26, 275-298.
- Vygotsky, L. S. (1936/1987). *Thinking and Speech*. In R. W. Rieber & A. S. Carton (Eds.), *The collected work of L. S. Vygotsky* (N. Minick, Trans.). New York: Plenum Pr
- Wood, T. (1995). An emerging practice of teaching. In P. Cobb & H. Bauersfeld (Eds.), *The emergence of mathematical meaning* (pp. 203-227). Hillsdale, New Jersey.
- Yackel, E. (2002). What we can learn from analyzing the teacher's role in collective argumentation. *Journal of Mathematical Behavior*, 21, 423-440.



# LEARNING MATHEMATICS FOR TEACHING

Nanette Seago

Lynn Goldsmith

WestEd

EDC

*The identification of mathematical knowledge for teaching (Ball & Bass, 2000), leads to questions about how to promote and assess it. What kinds of professional development experiences might provide teachers with the opportunity to develop mathematical knowledge for teaching? What does it mean to learn it? In this paper, we address these questions with illustrations of teachers learning various aspects of mathematical knowledge for teaching. These teachers were participants in Turning to the Evidence<sup>1</sup>, a study investigating the role of practice-based professional development centered in the use of classroom artifacts (e.g., student work and classroom video) and its effect on teacher learning<sup>2</sup>.*

## MATHEMATICAL KNOWLEDGE FOR TEACHING

Mathematical knowledge for teaching focuses attention on the considerable *mathematical* demands that are placed on classroom teachers (Ball & Bass, 2000; Ball, Bass, & Hill, 2004). Building on Shulman's (1986) notion of pedagogical content knowledge, characterized as "bundled" mathematical, pedagogical, and cognitive/developmental knowledge which can help teachers anticipate and address typical issues of students' learning mathematics, Ball and Bass posit an "unbundled," complementary mathematical knowledge that teachers must call upon as needed in the course of classroom practice to effectively engage students in learning.

Although pedagogical content knowledge provides a certain anticipatory resource for teachers, it sometimes falls short in the dynamic interplay of content with pedagogy in teachers' real-time problem solving. . . . [A]s they meet novel situations in teaching, teachers must bring to bear considerations of content, students, learning, and pedagogy. They must reason, and often cannot simply reach into a repertoire of strategies and answers. . . . It is what it takes *mathematically* to manage these routine and nonroutine problems that has preoccupied our interest. . . . It is to this kind of *pedagogically useful mathematical* understanding that we attend to in our work. (Ball & Bass, 2000, p. 88-9, italics in original)

They also argue that the kind of pedagogically useful mathematical knowledge and understanding differs in a number of ways from the mathematical knowledge and

---

<sup>1</sup> The Turning to the Evidence project is supported by the National Science Foundation under grant no. REC-0231892. Any opinions, findings, conclusions, or recommendations expressed here are those of the authors and do not necessarily reflect the views of the National Science Foundation.

<sup>2</sup> We would like to acknowledge Mark Driscoll, Johannah Nikula, Zuzka Blasi, Daniel Heck and Joe Maxwell for their contributions to the ideas discussed in this paper. In addition, we would like to thank Judith Mumme for her contributions to the development of this work.

understanding required in other disciplines that use mathematics. For example, Ball and Bass argue that the mathematics needed for teaching requires an unpacking of fundamental ideas, while the mathematician seeks their elegant compression. They have identified several core activities of mathematics teaching such as: (1) figuring out what students understand; (2) analyzing methods and solutions different from one's own, determining their adequacy, and comparing them; (3) unpacking familiar mathematical ideas, procedures, and principles; and (4) choosing representations to effectively convey mathematical ideas.

While these core activities can serve as productive arenas for the investigation of teachers' learning of mathematics knowledge for teaching, they raise questions about how to promote this kind of learning in teachers. What kinds of experiences might provide teachers with the opportunity to further develop this specialized kind of mathematical content? What does it mean to learn it?

Several research projects have demonstrated that practice-based (Smith, 2001) professional development projects that utilize artifacts of practice, such as classroom video and student work, are effective tools in efforts to increase teachers' opportunities to learn mathematics knowledge for teaching (Borko, 2004). By bringing the everyday work of teaching into the professional development setting, these tools enable teachers to unpack the mathematics in classroom activities, examine instructional strategies and student learning, and discuss ideas for improvement (Ball & Cohen, 1999; Driscoll et al., 2001; Kazemi & Franke, 2004; Schifter et al., 1999a, 1999b; Seago et al., 2004).

In this paper, we highlight different aspects of mathematical knowledge for teaching (MKT) that we have seen teachers develop through their engagement in professional development centered around the use of classroom artifacts. The teachers described in this paper were participants in the Turning to the Evidence Project, a study investigating the role of classroom artifacts in teacher learning (Seago & Goldsmith, 2005). The professional development focused on a number of the core activities described by Ball and Bass, such as: unpacking familiar mathematical ideas, analyzing alternative methods and solutions, and choosing and using mathematical representations. We present data collected about three participants in this professional development to show how each developed their thinking in one of these areas of MKT

## **THE TURNING TO THE EVIDENCE STUDY**

Seventy-four middle and high school teachers participated in this study; 49 teachers enrolled in one of four professional development seminars and 25 served as comparison teachers for pre- and post-program assessments. Two of the seminars used materials from the Fostering Algebraic Thinking Toolkit (Driscoll, et al., 2001) and two used modules from Learning and Teaching Linear Functions: VideoCases for Mathematics Professional Development (Seago et al., 2004). In all,

18 teachers participated in Fostering Algebraic Thinking (AT) seminars and 31 in Learning and Teaching Linear Functions (LF) groups.

The two sets of materials within this study are both grounded in situative perspectives on learning. A key principle of situative perspectives is that the activities and contexts in which people learn become a fundamental part of what they learn (Greeno, 2003; Greeno, Collins, & Resnick, 1996). Although this principle suggests that teachers' own classrooms are powerful contexts for their learning, it does not assert that professional development activities should occur only in classrooms (Putnam & Borko, 2000). Both LF and AT use artifacts (e.g., videotapes, samples of student work) to bring teachers' classrooms into the professional development setting, enabling teachers to examine instructional strategies and student learning, and to discuss ideas for improvement (Ball & Cohen, 1999).

The professional development for both programs is structured in similar ways—both include work on the mathematical task prior to examining and discussing the classroom artifact with the goal to help teachers learn to more deeply focus their attention on students' mathematical thinking and to connect seminar work to their own practice. The materials differ in two ways: (1) the mathematical focus (algebraic habits of mind versus unpacking linearity, and (2) the kinds of artifacts used (written artifacts of student problem-solving versus video episodes of classroom discussions).

### **Data sources**

The project collected information from several data streams, including a background questionnaire completed at the beginning of the project by all participants, pre- and post-program assessments of mathematics knowledge for teaching (Math Survey) and analysis of classroom artifacts (Artifact Analysis) using paper-and-pencil instruments.

The Math Survey includes both multiple choice and open-response items focusing on understanding algebra (with a particular emphasis on linearity). In constructing the survey, we drew heavily on items from the SII database and also included items used to assess teachers' learning in California Mathematics Professional Development Institutes (Hill & Ball, 2004). The Artifact Analysis was a two-part instrument designed for this project. The first involved viewing and answering a series of increasingly specific questions about a short video segment of a class discussion that centered on students' presentation of generalizations of a linear relationship set in a geometric context. The second part asked teachers to comment on three pieces of written student work for the same problem. This measure replicated the professional development work of both projects in that it used both types of artifacts—video and student work. In addition, videotapes of all professional development seminars were collected and transcribed for analysis in order to study teachers' professional development experiences.

## **LEARNING MATHEMATICAL KNOWLEDGE FOR TEACHING: *What do teachers know that they didn't know before?***

In this paper we draw from the larger study of 49 teachers to examine what kinds of MKT learning are possible when teachers participate in practice-based professional development that utilizes artifacts of practice. The teacher learning cases included in this paper illustrate what teachers can learn by examining a few individual teachers across the data sources, creating learning stories with corresponding evidence. In doing so, we illustrate the learning of specific knowledge such as: learning to analyze various methods for solving problems, learning to unpack mathematics, and learning to use mathematical representations. We do not make claims about what all teachers in the study learned, but rather about what it looks like when a teacher learns about a particular aspect of MKT.

We focus primarily upon three teachers: Trevor, Charles, and Laura in our illustrations of the learning of MKT. We primarily chose these three teachers because they each showed gains in different types of learning. Additionally, we chose these teachers based on how they scored on the pre-program Math Survey. We chose one teacher that scored high (Charles) and two that scored low (Trevor and Laura), because we found their initial scores and their gains in mathematical knowledge for teaching interesting.

### **Learning to unpack the mathematics**

Trevor has a bachelor's degree in mathematics and taught high school during the time he was involved with the Video Cases seminars. In the background questionnaire, he wrote that he had signed up for the seminar in hopes of "finding alternative approaches to teaching algebraic thinking and computational skills." Trevor showed 17% improvement on the Math Survey (MS). On his post-program MS, Trevor not only answered more problems than he had on the pre-program MS (from 27 to 35), but he also showed significant improvement in problems that required him to employ conceptual understanding of  $y$ -intercept, as well as geometric representations of linear growth. Three problems he got wrong in the pre-program MS that he answered correctly in the post-program MS were word problems that involved translating a linear relationship into a formula while recognizing the starting point ( $y$ -intercept), the slope, and the variable. The three problems all began with a statement about the initial condition or starting point. This is especially interesting given the fact that Trevor's undergraduate degree is in mathematics.

Trevor's learning to unpack the mathematics of  $y = mx + b$ , specifically of the meaning of  $y$ -intercept ( $b$ ), shows up again in his participation in the seminars. In the eighth seminar, the group revisits a video segment from the first session in which a student (James) explains his recursive thinking—focusing on the growth of the pattern and not attending to the starting point. As was common during the beginning seminars, Trevor did not say much during the video portion within each session. His involvement primarily showed up within the portion of the sessions that worked on

the mathematical task. During the eighth session however, Trevor discusses James' thinking:

“He'd gotten so deep into the table that he forgot the part that starts the table going. . . if you just looked at lines 2, 3, and 4, you'll see a change taking place for sure, but that doesn't give you your initial conditions because you're seeing the changes taking place as you march down the table.”

After some discussion by the group about how to build upon James' idea and help him to see the initial starting point, Trevor suggests “ $b + mx$ ” as an alternative order. This shows Trevor has learned to appreciate the conceptual difference that putting the “ $b$ ” first might mean as he unpacks the parts of a linear equation.

Trevor recognizes his own learning to unpack the mathematics as he replies to a question about his own learning by saying that the “practice of looking at geometric representations of linear growth has developed in me to extract both the initial conditions and the constant of growth.” Trevor reported that he intends to utilize his learning within his teaching practice because he will “invest more preparation time looking for opportunities for student algorithmic development” and “it influenced me to try to get a depth of understanding in what I'm presenting so that I can anticipate the struggles my students are going through before they get there, and be able to help them through it when they do get there.”

### **Learning to choose and use mathematical representations**

Laura taught 6<sup>th</sup> grade during the time she was involved with the Video Cases seminars. She signed up for the LF seminars “in order to learn new teaching skills in hopes of becoming a better teacher”. While she entered into the professional development for pedagogical learning, she in fact gained mathematical knowledge for teaching specifically within the domain of choosing representations to effectively convey mathematical ideas.

Overall, Laura improved 20% from on the MS. She was able to answer 7 more questions on her post-program MS than on her pre-MS. She displayed more use of mathematical representations in solving the problems—she used tables, geometric models, arithmetic expressions and some algebraic notation. Though she showed signs of struggles with algebraic notation, she showed a marked increase in willingness to solve the problems.

The same theme emerged from her pre-program to post-program Artifact Analysis (AA)—she used more mathematical representations and displayed mathematical persistence and engagement with the problem—noting at one point a pattern she found as “cool.” In fact, in the pre-AA she commented mostly with general and non-mathematical statements. For example, Laura went from initially noticing management and social issues in the video to a more mathematically focused attention—from how many students were in the class and on-task to noticing that the students were looking at the “arms” of the figure. In addition, she improved in her ability to analyze student thinking more accurately and specifically. On the student work, she went from commenting on neatness and drawings to commenting on

whether or not formulas worked—from “the picture in 3D is much more accurate. I also noticed that I can read their writing,” to “the formula will not work. You must know the previous answer. The drawing is more accurate.” On another student’s work, she initially commented on the amount of written explanation, but in the post-AA she notices mathematical inconsistencies.

At the end of the seminar when asked if she thought that participating in the seminars influenced how she thought about math, she said it is harder than she thought it was—it is not so cut and dry. Laura stated that she believed it helped her to become a better teacher, but “I still have a long way to go—I would have to do more of this to really feel comfortable teaching it.”

### **Learning to figure out what students understand**

Charles taught 6<sup>th</sup> grade during the time he was involved with AT seminars. He signed up for the AT seminars in order to improve his own algebra as well as his teaching of the subject. By the end of his participation, he displayed an improved ability to figure out what students understand.

He improved upon his Math Survey by 11%, even though he reported that he was tired and “gave up more quickly” on the post-program version. Upon close examination of his pre and post-program MS, Charles appears to have made progress in his ability to reason from and with algebraic notation—he moved from using numeric substitution methods for checking accuracy of expressions, to reasoning about the geometric representation with algebraic notation. For example, one problem involved correctly choosing an algebraic representation of a student’s verbally explained method. In the pre-program MS, he chose a correct mathematically equivalent formula for the problem, but it did not accurately represent the student’s method. In the post-program MS, Charles correctly chose the algebraic formula that represented the student’s method. In addition, his work on the problems provided glimpses into his method for checking student’s accuracy—he moved from a substitution strategy in the pre-program version to using algebraic notation in reasoning about student’s methods in the post-program version.

Charles increased the mathematical specificity of his analysis of student thinking—in both the video and the written student work sections of the Artifact Analysis. Overall, Charles shifted from a focus on communication and explanation in the pre video analysis to a more mathematical focus on reasoning, and generalization. He displayed an increased ability to follow the mathematical logic of the students in a more precise analytical way. For example, in the pre-program AA, Charles interpreted one student’s work by stating “you can’t really tell what this student is thinking from the examples given; mixes written explanation with formula.” In examining the same student’s work on the post-program AA, Charles was much more precise in his analysis of the student’s thinking and much better at figuring out what students understand—he was able to break down the mathematical logic, noting places of confusion and shifting from a deficit view of the student’s thinking to suggesting there exists a basis for teaching “to what they know.”

When asked what he learned by participating in the seminars, Charles stated that he learned “skills like generalizing, patterns, breaking apart and chunking.” These mathematical processes allowed him to improve in the mathematical knowledge for teaching of figuring out what students understand.

## CONCLUSION

This paper has examined various data from three teachers to illustrate what mathematical knowledge for teaching teachers might learn from artifact-based professional development. By carefully examining the various sources of data and utilizing Ball and Bass’ definition of mathematical knowledge for teaching, we find evidence of gains in various domains of mathematics knowledge for teaching. Trevor, a mathematics major, came into the seminars with a lot of mathematical background and conventional, compressed knowledge—yet he scored low on the pre-program Math Survey. His improvement came on problems that required him to employ conceptual and unpacked understanding of y-intercept (starting point), as well as geometric representations of linear growth. He learned to unpack and conceptualize a familiar mathematical idea. Laura increased in her ability to use various mathematical tools and representations. This gained knowledge showed up in her increased ability to analyze student ideas more accurately and specifically using various mathematical representations. Charles increased in his ability to reason through student ideas—to figure out what students understand. In the student work, Charles moves from a focus on how the student communicates (written explanation and visual models) to specific and detailed mathematical analysis of the student’s logic—including interpretation and error analysis.

These cases provide an additional angle from which to view the practice-based theory of mathematical knowledge for teaching (Ball, Bass, & Hill, 2004). This work adds an interpretive frame for examining the construct of mathematical knowledge for teaching and what it might mean to learn it, by examining it from a different mathematical topic area (algebra), grade level (middle and high school teachers) and context—two practice-based professional development programs and their relationship to supporting teacher learning of mathematics for teaching.

## References

- Ball, D.L., & Bass, H. (2000). Interweaving content and pedagogy in teaching and learning to teach: Knowing and using mathematics. In J. Boaler (Ed.), *Multiple perspectives on the teaching and learning of mathematics*. (pp. 83-104). Westport, CT: Ablex.
- Ball, D., Bass, H. and Hill, H. (2004). Knowing and using mathematical knowledge in teaching: Learning what matters. In Buffgler, A. and Lausch, R. (Eds.) *Proceedings for the 12th Annual Conference of the South African Association for Research in Mathematics, Science and Technology Education*. Durban. SAARMSTE.
- Ball, D., & Cohen, D.K. (1999). Developing practice, developing practitioners: Toward a practice-based theory of professional development. In G. Sykes & L. Darling-Hammond (Eds.), *Teaching as the learning profession: Handbook of policy and practice* (pp. 3-32). San Francisco: Jossey Bass.

*Seago & Goldsmith*

- Ball, D., Hill, H., and Bass, H. (2005). Knowing mathematics for teaching: Who knows mathematics well enough to teach third grade, and how can we decide? *American Educator*. Fall 2005
- Borko, H. (2004). *Professional Development and Teacher Learning: Mapping the Terrain*. *Educational Researcher*, Volume 33, Number 8, pp. 3-15.
- Driscoll, M., Zawojewski, J., Humez, A., Nikula, J., Goldsmith, L., & Hammerman, J. (2001). *The fostering algebraic thinking toolkit: A guide for staff development*. Vols. 1-4. Portsmouth, N.H.: Heinemann.
- Greeno, J.G. (2003). Situative research relevant to standards for school mathematics. In J. Kilpatrick, W.G. Martin, & D. Schifter (eds.), *A research companion to principles and standards for school mathematics* (pp. 304-332). Reston, VA: National Council of Teachers of Mathematics.
- Greeno, J. G., Collins, A.M., & Resnick, L. (1996). *Cognition and learning*. In D.C.
- Hill, H.C., & Ball, D.L. (2004). Learning mathematics for teaching: Results from California's Mathematics Professional Development Institutes. *Journal for Research in Mathematics Education*. 35(5), 330-351.
- Kazemi, E., Franke, M. (2003). *Using student work to support professional development in elementary mathematics*. Center for Study of Teaching and Policy: University of Washington.
- Putnam, R.T., & Borko, H. (1997). Teacher learning: Implications of new views of cognition. In B.J. Biddle, T.L. Good, & I.F. Goodson (Eds.) *The international handbook of teachers and teaching* (Vol.II, pp. 1223-1296). Dordrecht, The Netherlands: Kluwer.
- Schifter, D., Bastable, V., Russell, S.J., Lester, J.B., Davenport, L.R., Yaffee, L., & Cohen, S. (1999a). *Building a system of tens*. Parsippany, NJ: Dale Seymour.
- Schifter, D., Bastable, V., Russell, S.J., Lester, J.B., Davenport, L.R., Yaffee, L., & Cohen, S. (1999b). *Making meaning for operations*. Parsippany, NJ: Dale Seymour.
- Seago, N., & Goldsmith, L. (2005). *Turning to the Evidence: Examining the impact of two professional development programs focused on algebraic thinking*. Paper presented at the annual meeting of the American Educational Research Association in Montreal, Canada. April, 2005.
- Seago, N., Mumme, J., & Branca, N. (2004). *Learning and teaching linear functions*. Portsmouth, N.H.: Heinemann.
- Shulman, L. S. (1986). Those who understand: Knowledge growth in teaching. *Educational Researcher*. 57(1), 1-22.
- Smith, M.S. (2001). *Practice-based professional development for teachers of mathematics*. Reston, VA: The National Council of Teachers of Mathematics.



# COHERENCE OF MATHEMATICS LESSONS IN JAPANESE EIGHTH-GRADE CLASSROOMS

Yasuhiro Sekiguchi

Yamaguchi University, Japan

*Recent international comparative studies indicated that mathematics lessons in Japanese classrooms were distinctly coherent. This paper is an attempt to understand the coherence issue from a more comprehensive perspective. First, a comprehensive framework for capturing the coherence of lesson was proposed based on the discourse research. Second, data from consecutive lessons were employed to explore connections not only within single lessons but also between lessons. An analysis from this perspective indicated that Japanese mathematics lessons by experienced teachers developed rich coherent discourse with a guide of a traditional lesson script.*

## INTRODUCTION

Stevenson and Stigler (1992) and TIMSS Video Study (Hiebert et al., 2003) reported that Japanese mathematics instructions had distinctly high coherence: Japanese lessons tended to contain explicit goal and summary statements, receive little interruptions, and use mathematically related problems. The current paper is to complement these results by broadening the framework of lesson coherence and the unit of data. More specifically, the purpose of this paper is two-fold. First, a comprehensive framework for understanding the coherence of lesson is proposed based on the discourse research. Second, data from consecutive lessons are employed to explore connections not only within single lessons but also between lessons.

## CONCEPTUAL FRAMEWORK

TIMSS 1999 Video Study analysed the coherence of mathematics lessons from pedagogical factors and mathematics problems:

Many factors can influence the clarity and coherence of mathematics lessons. Chapter 3 considered pedagogical factors that can influence the ease with which students identify the main points of the lesson (goal and summary statements) as well as factors that affect the flow of a lesson (lesson interruptions).

The mathematics content itself can contribute to the clarity and coherence of lessons. Because much of the content was carried through the mathematics problems of the lesson, the clarity and coherence of lessons might have been influenced by the way in which the problems within lessons were related to each other. (Hiebert et al., 2003, p. 76)

Also, a subgroup of the Study made a preliminary analysis on overall mathematical coherence of lesson. The coherence was there evaluated based on relations among themes or topics appeared in the lesson:

Coherence was defined by the group as the (implicit and explicit) interrelation of all mathematical components of the lesson. A rating of 1 indicated a lesson with multiple unrelated themes or topics and a rating of 5 indicated a lesson with a central theme that progressed saliently through the whole lesson. (Hiebert et al., 2003, p. 196)

Thus, they recognized that multiple dimensions need to be considered for lesson coherence, but they have not provided any comprehensive framework for it.

The current paper aims to take a broader perspective from the viewpoint of discourse coherence (Brown & Yule, 1983; Tomlin et al., 1997). Discourse participants try to communicate their ideas through language or some other media. As symbolic interactionism says, they actively engage in constructing their own interpretation of each other's ideas. According to Tomlin et al. (1997), the speaker considers four different dimensions of discourse management in order to help the listener construct a coherent knowledge: rhetorical, thematic, referential, and focus management. And, the speaker normally manages more than one dimension simultaneously. Any piece of the discourse could have multiple functions (cf. Redeker, 2000).

The current paper adapts this framework to the coherence of classroom discourse. In terms of classroom discourse, the above mentioned dimensions would be formulated this way (for explanation in linguistics, see Tomlin et al., 1997): The teacher intends to provide the students with a certain coherent vision of mathematical knowledge. In a lesson the teacher has some goals or intentions, and tries to produce discourse interaction with them in mind. This dimension of coherence between goals and discourse production is called "rhetorical" management. With rhetorical goals in mind the teacher tries to organize topics and themes into a connected whole. This dimension of coherence is called "thematic" management. When introducing a topic or theme and discussing it, the teacher needs to monitor what are taken to be shared or not among the students. This dimension is called "referential" management. Finally, in the course of discourse interaction the teacher needs to make sure that students pay attention to the right thing at the right time by stressing or highlighting it. This dimension is called "focus" management.

## **RESEARCH PROCESSES**

This paper is a part of *Learner's Perspective Study (LPS)*, an international project coordinated by David Clarke (Clarke, 2004). This project collects and analyses data of eighth-grade mathematics lessons of various countries. Unlike TIMSS Video Study, in *LPS* project, eighth-grade teachers were not randomly selected. Only those who were considered "competent" by local educators were selected. In addition, for each teacher, ten consecutive lessons were videotaped by three cameras, capturing teachers, students, and the whole class. Teachers and students were interviewed by the stimulated-recall method using videotapes of the lessons.

This paper analyzes two Japanese teachers' ten consecutive lessons that were located in the unit of linear functions (Site J1) and simultaneous linear equations (Site J3). The videotapes of the lessons, their transcripts, and the interview data were analyzed qualitatively from the above discussed framework.

Because of the limitation of space, data from Site J1 is mainly discussed below (Site J3 is occasionally mentioned). In the following, the lessons are numbered, and indicated by symbols like L3 (the third lesson of the ten lessons).

## COHERENCE OF MATHEMATICS LESSONS

### Unit of discourse

When studying coherence of discourse, we need to consider what collection of discourse segments are conceived as one "chunk," a connected whole. That is, what should be the unit of classroom discourse? A simple question-and-answer exchange like "Did you get the answer?" "No!" is certainly a connected discourse, but this size of discourse is too small to understand the coherence of classroom lessons. TIMSS Video Study used single lesson as the unit. It is a reasonable choice for a unit of international comparative analysis on teaching because it is the unit of school time management, and an internationally recognized concept. On the other hand, to understand the teaching practice in depth, it would be important to incorporate the perspectives of teachers and students when considering the unit. As Stigler and Hiebert (1999) mentioned, "teaching is a cultural activity" (p. 85). To understand teaching as a cultural practice, we need to take the participants' perspectives into consideration (Pelto & Pelto, 1978, pp. 54-66).

Japanese teachers usually consider one whole teaching unit as one set: They would not talk about a lesson without mentioning in which teaching unit it is located. They spend about ten to twenty school hours for one unit. They often divide the whole unit into several subunits. Textbooks are important resources when they plan the construction of the whole unit. Overall, a unit and its subunits of teaching seem to correspond to a chapter and its sections of a textbook.

Actually, the teacher of Site J3 mostly used problems in the textbook as main topics of lessons, and there appears to be a parallelism between the construction of the textbook and the topics of lessons (Table 1).

There were some cases where the teacher did not follow the order of topics of the textbook, however. For instance, he introduced a different way of solving simultaneous equation from the addition and subtraction method in L1. Though that actually used the idea of the substitution method (it was formally introduced in L7), he discussed it using a student's solution method. Students' ideas were thus partially incorporated into the construction of teaching unit.

Headings of the textbook	Lessons of Site J3
Section 1: Simultaneous equations	
1. Simultaneous equations and their solutions	N/A
2. Solving simultaneous equations	L1-L7
- Addition and subtraction method	L1-L6
- Substitution method	L7
3. Various types of simultaneous equations	L8-L9
Section 2: Applications of simultaneous equations	L10

Table 1: Relation between the textbook and the lessons at Site J3.

### Rhetorical management

It has been well known among Japanese teachers that Japanese lesson has a three-phase script like a story: Introduction (“dounyu”), Development (“tenkai”), and Summary (“matome”) (Stevenson & Stigler, 1992; Stigler & Hiebert, 1999). In mathematics lessons, Development phase is often divided into two phases, resulting a four-phase script (“problem-solving style lesson”):

Phase 1: The teacher presents one problem.

Phase 2: Students first try to solve it individually. Then, they may work with neighbors, or in small groups.

Phase 3: Some students present their solutions on the blackboard, and the class discuss the presented solutions.

Phase 4: The teacher summarizes important points.

We have to keep in mind here that a “story” does not necessarily end within a single lesson. In fact, for example, at Site J1 the teacher spent three hours (L1-L3) to complete the activity started from one problem, as discussed below.

### Thematic management

There are many theoretical arguments about theme and topic in linguistics. But, they are mostly concerned with a sentence or short exchanges, or written discourse. Theoretical studies on theme and topic in a long interactive discourse like classroom lessons is very limited (for an exception, Voigt, 1995). Mostly, discourse topic is defined intuitively as what is being talked about. Though some linguists attempted to define “topic” formally, Brown and Yule (1983) claimed “the formal means of identifying the topic for a piece of discourse ... is, in fact, an illusion” (p. 110). The observer needs to figure out what a speaker is talking about through various data sources.

Theme is defined by topics. Common ideas considered to cover a series of topics in a discourse is called a theme of the discourse. A conversation like just jumping around unrelated topics may have no theme. Themes usually emerge through discourse topics. They could be formulated variously. The speaker could set a theme of

discourse at the beginning, for example, by saying or writing a title of talk, but until other participants accept it as a theme, it is not considered as such.

At Site J1, the content of the unit was linear function, and the title of chapter of the textbook was “linear functions.” If the teacher wrote “linear functions” as a title on the blackboard at the beginning of the unit, she could easily set it as a theme because teachers have the power to control discourse topics. The teacher did not mention the term “linear functions” by the third lesson of the unit, however. Instead, she initiated the first lesson of the unit by asking the class about what changes occurred during the last vacation, and then introduced “how to investigate changes” as a global theme of the unit. If she had introduced the new term “linear functions” at the outset of the unit, she would have had to define it and present its examples because the students did not know the term. Rather, she seemed to have wanted to formulate a theme in common words so that the students could easily understand, relate to their experiences, and accept it.

The teacher then introduced an open-ended problem “staircase”-pattern problem (Figure 1) as a theme, and asked the students to list changing aspects of the pattern. The students came up with many aspects: size, area, height, perimeter, the number of right angles, the number of edges, and so on.

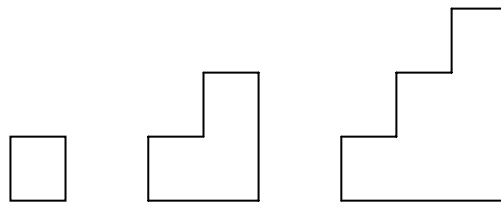

Figure 1: Staircase-pattern problem.

Then, the class first investigated the perimeter of staircase together. After that the teacher assigned the students homework of investigating other aspects. The next lesson L2 discussed other aspects based on what students did as homework. In L3, the class started to investigate the number of right angles in the pattern together.

After the investigation of the number of right angles in L3, the class reflected on the types of equations found in the past investigations of the staircase pattern, by comparing them. The new concept “linear functions” emerged as a central theme, and the teacher explained it formally.

Thus, the three consecutive lessons L1-L3 seems to follow the script of Introduction-Development-Summary:

Introduction: Introduction of the staircase-pattern problem

Development: Investigation of various aspects of the staircase-pattern

Summary: Introduction of the concept of linear functions to recapitulate the results

Though the three-phase script is often identified within single lessons (cf. Stevenson & Stigler, 1992; Stigler & Hiebert, 1999), it is thus found between lessons also. In addition, the script is not just an activity pattern, but functions as a guide for connecting topics and themes. These connections were further strengthened by the

homework assigned at the end of lessons. Homework mostly was used not just as practice or review of what the students studied during the class, but also as topics to be discussed at the next lesson. Thus, homework functioned as connector to topics or themes of the next lesson. The same pattern was observed thereafter also (Table 2).

Lesson number	Main activities
L1-L3	Investigation of the staircase-pattern problem
L4-L7	Investigation of the “origami” problem
L8-L9	Investigation of relations between equations and graphs of linear functions
L10	Solving review exercises

Table 2: Lesson activities at Site J1.

### **Referential management**

Tomlin et al. (1997) says, “One important problem in reference management has been understanding how speaker and listener keep track of referents during discourse production and comprehension” (p. 80). Unlike standard samples of discourse in linguistics, there are many strategies and tools available to help the participants keep track of referents in classroom discourse: naming, symbolizing, drawing, reviewing, summarizing, using textbooks, blackboards, worksheets, notebooks, and projectors, and so on.

The use of blackboard is one of the most effective strategies to cope with the limitation of human short-time memory in classroom lessons. Especially, experienced Japanese teachers are known to be very deliberate in the blackboard writing (“bansho”). They use large blackboards in so well-planned manner that the students can easily understand and remember what have been discussed, and also take notes of it neatly for review.

Figure 2 is a scene taken in L1 of Site J1, at 42 min. 46 sec. from the start of the lesson, close to the end. At that moment, on the leftmost part of the board was a large figure of the staircase pattern drawn on a white paper. This was presented at the beginning of the lesson. On the centre of the board, all the changing aspects that students found are listed. This was written when discussing changing aspects of the staircase pattern. On the rightmost part (only its half appears on the photo) is a table and an equation from student’s investigation about change of perimeter. This was written by a student after the class chose one aspect, perimeter, and investigated its change. Parallel with the flow of the lesson, the main topics were written down from left to right. All the main points of the lesson were visually summarized on the blackboard at the end of the lesson.

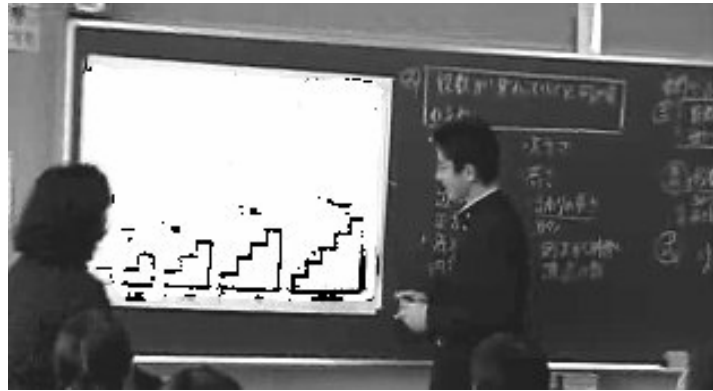

Figure 2: Blackboard writing.

### Focus management

Focus information of discourse is what the listener is expected to know or accept by discourse interaction. That is, “the point” of discourse. The teacher always needs to make sure that the students “see the point.” There are many strategies to keep students’ attention on the right focus. One of the most powerful strategies is to use a comparison or contrast. A comparison strategy is integrated into the above mentioned “problem-solving style” script of Japanese mathematics instruction. In the script, students are often encouraged to find various ways of solving (at Phase 2), then present them in front of the class (at Phase 3). Then, the class compare, discuss, and appreciate them. The teacher’s summary at Phase 4 further ensure the students’ understanding of the main points.

At Site J1, from L1-L3 the class found and investigated various aspects of change in the staircase pattern. The pattern of linear function stood out from the investigation and discussion. The teacher’s introduction of the concept at the end of L3 was clearly highlighted.

### CONCLUDING REMARKS

This paper adapted a framework of discourse coherence to the analysis of discourse of mathematics lessons. It is still under development, and further elaboration of the framework is necessary through data analysis. Especially, where “mathematical” aspects are located in the framework would be an important issue (cf. Kaldrimidou, 2002). Also, the coherence of classroom discourse is generally expected to be related to students’ knowledge integration, but this point would require much more research.

The analysis of Japanese mathematics lessons indicated that Japanese mathematics lessons by experienced teachers developed rich coherent discourse with a guide or “scaffolding” (cf. Anghileri, 2002) of a traditional lesson script. This point should be further investigated through comparison with lessons of other countries.

### References

- Anghileri, J. (2002). Scaffolding practices that enhance mathematics learning. In A. D. Cockburn & E. Nardi (Eds.), *Proc. 26<sup>th</sup> Conf. of the Int. Group for the Psychology of Mathematics Education* (Vol. 2, pp. 49-56). Norwich, UK: PME.

- Brown, G. & Yule, G. (1983). *Discourse analysis*. Cambridge: Cambridge Univ. Press.
- Clarke, D. (2004). Learner's perspective study: Developing meaning from complementary accounts of practice. In M. J. Høines & A. B. Fuglestad (Eds.), *Proc. of 28<sup>th</sup> Conf. of the Int. Group for the Psychology of Mathematics Education* (Vol. 1, pp. 212-216). Bergen, Norway: PME.
- Hiebert, J. et al. (2003). *Teaching mathematics in seven countries: Results from the TIMSS 1999 Video Study*. Washington, DC: U.S. Department of Education.
- Kaldrimidou, M. (2002). Teachers' role in the management of mathematical knowledge: An analysis of problem solving process. In A. D. Cockburn & E. Nardi (Eds.), *Proc. 26<sup>th</sup> Conf. of the Int. Group for the Psychology of Mathematics Education* (Vol. 3, pp. 169-176). Norwich, UK: PME.
- Pelto, P. J. & Pelto, G. H. (1978). *Anthropological research: The structure of inquiry* (2nd ed.). Cambridge, UK: Cambridge University Press.
- Redeker, G. (2000). Coherence and structure in text and discourse. In W. Black & H. Bunt (Eds.), *Abduction, belief and context in dialogue: Studies in computational pragmatics* (pp. 233-263). Amsterdam: Benjamins.
- Stevenson, H. W. & Stigler, J. W. (1992). *The learning gap*. New York: Summit Books.
- Stigler, J. W. & Hiebert, J. (1999). *The teaching gap*. New York: Free Press.
- Tomlin, R. S., Forrest, L., Pu, M. M., & Kim, M. H. (1997). Discourse semantics. In T. A. van Dijk (Ed.), *Discourse as structure and process* (pp. 63-111). London: Sage.
- Voigt, J. (1995). Thematic patterns of interaction and sociomathematical norms. In P. Cobb & H. Bauersfeld (Eds.), *The emergence of mathematical meaning* (pp. 163-201). Hillsdale, NJ: LEA.



# TRIANGLE PROPERTY RELATIONSHIPS: MAKING THE CONNECTIONS

Penelope Serow

University of New England, Australia

*Thinking that is characteristic of Level 3 in the van Hiele theory is focused on the relationships that exist among figures and those that exist among the properties. Whilst such knowledge is considered an important base that appears to assist in the retention and usability of geometrical facts, it remains unclear how relationships between individual properties develop. This study, involving in-depth interviews with 24 secondary students, addresses this issue by considering their attempts at providing minimum descriptions or definitions of particular triangles. The purpose of this paper is to report the findings of an initial exploration, utilising the SOLO model into the quality of the students' responses. The findings provide some light on the development of triangle property relationships.*

## INTRODUCTION

The van Hiele Theory (van Hiele, 1986) comprises five levels of development in Geometry from which to view students' understandings. Numerous studies have focused upon the holistic aspects of the first four van Hiele levels (Burger & Shaughnessy, 1986; Fuys, Geddes & Tischler, 1985; Mayberry, 1981; Usiskin, 1982) and this has resulted in supportive empirical evidence of the existence and nature of the levels. The level pertinent to this study, is described as Level 3, and includes the formation, and awareness, of a network of relations among properties and figures; the ability to describe descriptions of figures and properties based upon known relationships; and, the recognition of class inclusion concepts, and the implications of these. This study intensively explores the nature of students' responses, made in an interview situation, of known and utilised relationships among triangle properties. Hence, attempting to address the need to shed light upon the development of property relationships.

To assist the analysis, the SOLO model was used as an interpretative tool once the categories of responses were identified. The SOLO model grew from Biggs and Collis (1982) desire to explore and describe students' understandings in the light of the criticisms of the work of Piaget. Rather than focus on the level of thinking of the student, the emphasis in the SOLO model is on the structure of students' responses. The framework is comprised of two main components, these being: the modes of functioning; and, the cycles of levels.

There are two modes of functioning relevant to this paper, namely, concrete symbolic (C.S.) and formal (F). The concrete symbolic mode involves the application and use of a system of symbols, for example, written language and number problems, which

can be related to real world experiences. The formal mode is characterised by a focus upon an abstract system, based upon principles, in which concepts are imbedded. Within each mode there occurs development, and development is described in terms of levels. General descriptions of the levels are:

- Unistructural (U) - response is characterised by a focus on a single aspect of the problem/task.
- Multistructural (M) - response is characterised by a focus on more than one independent aspect of the problem/task.
- Relational (R) - response is characterised by a focus on the integration of the components of the problem/task.

Studies (Campbell, Watson, & Collis, 1992; Pegg, 1992) have extended the SOLO model through the suggestion that more than one cycle of levels exist within each mode. As a result, studies have identified two cycles of levels in the concrete symbolic mode. This study identifies cycles of levels.

## **DESIGN**

Three research questions guided the study. They are:

1. Can students' demonstrated understandings of relationships among triangle properties be categorised into identifiable groups according to similar characteristics?
2. Was there evidence of some developmental pattern in the different responses to a task requiring the utilisation of relationships among triangle properties?
3. Does the SOLO model offer a framework to explain the identified categories of responses concerning students' understandings of relationships among triangle properties?

This paper reports the results of one aspect of a larger study developed to explore students' understandings of the relationships among figures and properties. Twenty-four students, six from each of Year 8 to Year 11 (ages 13 to 17), were selected from two secondary schools. The students were of above average ability and there were equal numbers of males and females.

The nature of this study was to have the students complete a task which focused upon known relationships among triangle properties. The triangles chosen for this task were the equilateral triangle and right isosceles triangle. While a summary of the interview is contained in Figure 1, the structure allowed for individual dialogue incorporating prompts and probes where necessary. The students were provided with a focus for discussion, which involved properties of the triangles known by the individual student. Through discussion of the student devised clue combinations, a vehicle was provided which initiated discussion concerning triangle property relationships while remaining in the working domain of the individual student.

- Triangle Property Relationships
- (i) Int: We are going to look closely at a few triangles. The cards in front of you have triangle characteristics on them. I would like you to begin by choosing the cards which belong to the equilateral triangle (selection made). Look carefully to make sure that you have included all the cards which belong to that triangle.
- (ii) Int: Suppose you wanted to leave some clues for a friend. Do you think that your friend would need to see all these properties to know that you are thinking about an equilateral triangle? What combination could you leave? (discussion follows concerning reasons for cards included in the combination and those that have been removed) Do you think it could be made simpler? (discussion follows concerning reason for the simplification or inability to make simpler)
- (iii) Int: Let's put all the cards back. I would like you to make a different set of clues for your friend. (point (ii) repeated until student has provided all known combinations)
- (iv) First three steps repeated for the right isosceles triangle.

Figure 1: Summary interview structure

At the beginning of the interview each student was shown a selection of twelve cards. These are referred to as 'characteristic cards' and are listed below:

3 SIDES	3 ANGLES EQUAL	NO AXES OF SYMMETRY
3 ANGLES	3 SIDES EQUAL	3 AXES OF SYMMETRY
HAS RIGHT ANGLE	2 ANGLES EQUAL	1 AXIS OF SYMMETRY
HAS OBTUSE ANGLE	2 SIDES EQUAL	HAS ACUTE ANGLES

## RESULTS

Of interest to this analysis are the combinations of relationships utilised, and the variety of justifications provided within the responses. It was possible to divide the 24 responses for both the equilateral triangle and right isosceles triangle into seven groups.

A description of the response types follows. The descriptions include interview excerpts which illustrate identified relationships and student justifications. Each response indicated that the relationship between number of sides and number of angles was known and utilised, and therefore is not incorporated into the analysis. A concise characterisation of each response group's SOLO coding summarises each category. Four of the response groups, Types A, B, C, and D fall within the concrete symbolic mode (C.S.) when considered in the light of the SOLO model. Types E, F, G, and H are characteristic of the formal mode (F.).

**Type A** This type of response indicated a strong reliance on specific visual or traced examples of the triangle type from which the properties were determined. While side, angle, and symmetrical properties were chosen from the list provided, in each case the student first drew or traced the figure.

The student was aware that properties were relevant to the figure, however, there was no indication of known relationships between the properties. This type of response is characterised by the figure determining the properties; thus, the response is driven by the notion that if the property belongs to the shape it is required in the description. The relevant chosen properties are recognised from the figure individually. Ellen provided the following as a minimum set of cards to depict the equilateral triangle.

Combination 1. 3 SIDES EQUAL 3 ANGLES EQUAL  
3 AXES OF SYMMETRY

Interviewer: What if I took out that the three sides are equal?

Ellen: They wouldn't know then.

Interviewer: What if I took out three angles equal?

Ellen: No it has to stay there because you need to know that.

The Type A responses are coded as relational within the first cycle of the concrete symbolic mode ( $R_1$  C.S.), as there is reliance on specific examples from which a list of properties may be generated and on a demonstrated need for visual cues. Overall, the properties are perceived as features that are determined by the figure. All known properties are included in the description.

**Type B** These responses are characterised by the utilisation of one known property to provide a minimum description/definition of the triangle. The ultimate reference point is the particular triangle, which is considered to have a single property, which is unique to this type of triangle.

While the single minimum description provided initially reflects a possible understanding of property relationships, when the students were probed to justify the chosen combinations this understanding was not evident. This is evident in Peter's justification for his right isosceles triangle minimum combination below.

Combination 1. 3 ANGLES HAS RIGHT ANGLE 2 ANGLES EQUAL

Peter: I don't need the axis of symmetry.

Interviewer: Why can you take that one out?

Peter: I just don't think that you would really need to know that. It is not really necessary.

Interviewer: What about two angles equal?

Peter: Oh yeah that is pretty necessary if it is isosceles.

Interviewer: Is there any other combination that you could use?

Peter: No that is the only way.

The Type B responses are coded as unistructural in the second cycle of the concrete symbolic mode (U<sub>2</sub> C.S.). This response indicates the recognition of one property as a unique and necessary signifier for a particular triangle. Hence, only one minimum description/definition is identified within the response. The figure is the main point of reference, and determines the property.

**Type C** The Type C responses also incorporated no relationships among the properties of the triangle. The student provided more than one minimum description. Each description included one property, which was used in isolation, as a necessary indicator of the particular triangle.

The characteristics of the Type C response are reflected in Nathan's attempt at providing minimum descriptions/definitions for the equilateral triangle.

Combination 1. 3 SIDES EQUAL

Nathan: I could just use that one.

Interviewer: So why can you just use that one?

Nathan: There is no other triangle that has just three sides equal.

Combination 2. 3 ANGLES EQUAL

Interviewer: So why can you have either of those?

Nathan: Because um either makes it unique.

Interviewer: Could you have another set of clues?

Nathan: You could have three axes of symmetry.

Interviewer: Why would that work?

Nathan: Because it is the only triangle with three axes of symmetry.

The Type C responses are coded as multistructural in the second cycle of the concrete symbolic mode (M<sub>2</sub> C.S.). In summary, more than one property is identified as unique to a particular triangle type. More than one minimum description is provided, and no links exist between the properties. The properties utilised are determined by the figure and perceived as significant signifiers.

**Type D** This group of responses is similar to the Type C response, with the addition of a single link between two properties, which is utilised in one direction at any one time. While these responses are characterised by the inclusion of one or more isolated property signifiers of a particular triangle, the students' justification was also based upon a tentative connection between two properties.

While one property is described as relating to another, the relationship has not become a workable unit. Hence the student was unable to include a second combination based upon the link as evident in the following response.

Combination 1. 3 SIDES 3 AXES OF SYMMETRY

Interviewer: Why is that enough?

Louise: Well the only triangle that has three axes of symmetry is the equilateral.

Combination 2. 3 ANGLES EQUAL

Louise: Just three angles. If the angles are equal it is an equilateral.

Interviewer: So why don't you need to have that the three sides are equal?

Louise: Because if it has got um three angles that are equal it has three sides that are equal.

Interviewer: Can you find another combination of cards, which denote the equilateral triangle?

Louise: No, that would be it.

The Type D responses were coded as relational in the second cycle of the concrete symbolic mode ( $R_2$  C.S.). In general, a link between two properties is evident in the justification of minimisations; however, it remains verbose, tentative, and is not incorporated readily in both directions. Hence, the link has not formed a workable unit. Ordering exists between two properties.

**Type E** This group of responses made explicit reference to a single relationship between two properties as the basis for the minimum property combinations formed. While a third property may be known, it does not link to any other properties. These responses included justifications and property combinations that utilise one bi-directional relationship between two properties.

It is evident in Peter's justifications below that the chosen combinations for the equilateral triangle are based upon the bi-directional relationship between 'three sides equal' and 'three angles equal.'

Combination 1. 3 ANGLES 3 SIDES EQUAL HAS ACUTE ANGLES

Interviewer: Why can you remove three angles equal?

Peter: Well if there were three sides equal then the angles would be equal as well. I suppose I could have removed that one and left that one it doesn't really make that much of a difference.

Combination 2. 3 ANGLES 3 ANGLES EQUAL

Interviewer: Can you come up with any other combinations?

Peter: No, I don't think so.

The Type E responses are coded as unistructural in the first cycle of the formal mode ( $U_1$  F.). The focus of the minimisations provided is the single relationship between two properties. This relationship has formed a readily available unit. The response indicates a perception that the property relationships determine the figure, as opposed to being determined by the figure or belonging to the figure.

**Type F** This group of responses is characterised by minimum property combinations which incorporate two or more relationships among known properties. These responses included property combinations, which have formed separate workable units that are treated in isolation.

It is evident in the excerpt below that Allan is focused upon two isolated relationships, these being: between three sides equal and three angles equal, and three sides equal and three axes of symmetry.

Combination 1. 3 SIDES EQUAL

Interviewer Now why would you only need that?

Allan: Because by having three sides equal it is going to have three angles equal anyway because of the three sides, um and three sides equal will mean that it has got three axes of symmetry and three sides are equal well it has got to have three acute angles because it has got to be 180 divided by three and two angles will be equal for the same reason as three.

Combination 2. 3 ANGLES EQUAL

Combination 3. 3 SIDES 3 AXES OF SYMMETRY

The Type F responses are coded as multistructural in the first cycle of the formal mode ( $M_1 F$ ). In summary, this response is based upon the links existing between more than one pair of properties; however, they are perceived to be in isolation.

**Type G** The Type G responses utilise all relationships that exist between the known properties. The minimum combinations chosen are based upon the bi-directional relationships that exist between side, angle, and symmetrical properties. All properties are utilised and justified through their relationship with other properties of the particular triangle.

It is evident in the excerpt below, given by Frances, that the focus is upon the interrelationships between ‘two sides equal,’ ‘two angles equal,’ and ‘one axis of symmetry.’ Although Frances’ language is not succinct, for example “two bottom ones” for angles, and “you fold it” for symmetry, Frances spontaneously utilises the relationships between these properties, and no prompting is required.

Combination 1. 3 SIDES HAS RIGHT ANGLE 2 SIDES EQUAL

Interviewer: How come two angles equal can go?

Frances: Because being isosceles, like those two are the same then those two bottom ones are the same, and you have the axis of symmetry.

Combination 2. 3 ANGLES HAS RIGHT ANGLE 2 ANGLES EQUAL

Combination 3. 3 ANGLES HAS RIGHT ANGLE 1 AXIS OF SYMMETRY

Interviewer: Why is that one enough when you haven't mentioned anything about two sides equal or two angles equal?

Frances: Um because it means that you can fold it and then those two sides will be equal and those two angles will be equal.

The Type G responses are coded as unistructural in the second cycle of the formal mode ( $U_2 F$ ). These responses include the consideration of the network of relationships among the triangle properties. Responses are focused upon the interrelationships between the properties.

## CONCLUSION

There was evidence of characteristically different thinking associated with students' understanding of the relationships among properties. A developmental path was identified due to the observed change in perception of the role of properties and the relationships between them. The first level of understanding, as evident in this sample, perceived a property as a feature of specific examples of triangle types—the property is seen to be generated from the shape. This perception is subsumed by another, where a single property is perceived as a unique signifier of a particular triangle type. The property can be used in isolation when minimising; however, it is not linked to another property. It is not until the property is perceived as determining the particular triangle that a progression to utilising and justifying descriptions and definitions on the basis of property-to-property relationships occurs, and finally, justifications based upon the interrelatedness of properties among triangles.

Overall, the application of the SOLO model has provided a deeper interpretation of the response categories associated with the development of relationships between triangle properties. Through the identification of levels and modes within the response categories a framework emerged which has highlighted a pathway leading to an understanding of the interrelationships among triangle properties. This framework sheds light on the development of property relationships.

## References

- Biggs, J. B. & Collis, K. F. (1982). *Evaluating the Quality of Learning: The SOLO Taxonomy*, New York: Academic Press.
- Burger, W. F. & Shaughnessy, J. M. (1986). Characterising the van Hiele Levels of development in Geometry, *Journal for Research in Mathematics Education*, 17 (1), 31–48.
- Campbell, K. J., Watson, J. M. & Collis, K. F. (1992). Volume measurement and intellectual development, *Journal of Structural Learning*, 11 (3) 279–298.
- Fuys, D., Geddes, D. & Tischler, R. (1985). *An Investigation of the van Hiele Model of Thinking in Geometry Among Adolescents*, New York: Brooklyn College.
- Mayberry, J. (1981). *An Investigation of the van Hiele Levels of Geometric Thought in Undergraduate Pre-Service Teachers*, Thesis, Ed. D. University of Georgia.
- Pegg, J. E. (1992). Assessing students' understanding at the primary and secondary levels in the mathematical sciences, in M. Stephens and J. Izard (Eds.), *Reshaping Assessment Practices: Assessment in Mathematical Sciences Under Challenge*, (pp. 368–385), Melbourne: Australian Council of Educational Research.
- Usiskin, Z. (1982). *Van Hiele levels and achievement in secondary school geometry (Final report of the Cognitive Development and Achievement in Secondary School Geometry Project)*, Chicago, IL: University of Chicago, Department of Education.
- van Hiele, P. M. (1986). *Structure and insight: a theory of Mathematics education*, New York: Academic Press.



# ACCESS TO MATHEMATICS VERSUS ACCESS TO THE LANGUAGE OF POWER

Mamokgethi Setati

Marang Wits Centre for Maths and Science Education, University of the Witwatersrand, South Africa

*This paper explores how learners position themselves in relation to use of language(s) in multilingual mathematics classrooms. It draws from a study in multilingual mathematics classrooms in South Africa. The analysis presented shows that learners who position themselves in relation to English are concerned with access to social goods and are positioned by the social and economic power of English. They do not focus on epistemological access but argue for English as the language of learning and teaching. In contrast, learners who position themselves in relation to mathematics and so epistemological access, reflect more contradictory discourses, including support for the use of their home languages as languages of learning and teaching.*

## INTRODUCTION

Classroom conversations that include the use of [...] the [bilingual] students' first language as legitimate resources can support students in learning to communicate mathematically. (Moschkovich, 2002: 208)

I prefer that they teach us in English so that I can learn English. If you can't speak English, there will be no job you can get. In an interview you will find a white person not able to speak Sesotho or IsiZulu, you will lose the job because you don't know English. (Sipho, a Grade 11 mathematics learner, 2004)

Research argues that the learners' main languages are a resource in the teaching and learning of mathematics while learners argue for the use of English. The quotes above capture the essence and complexity of the arguments. These arguments are equally compelling as they are about access to mathematics and social goods (power and status). In this paper I use data from South Africa to explore the power dynamics that are evident in the language choices that learners make in relation to their learning of mathematics. Using data from South Africa is convenient but also appropriate: South Africa is an extraordinarily complex multilingual country. While the multilingual nature of South African mathematics classrooms may seem exaggerated, they are not atypical. In South Africa, there is a general view that most parents want their children to be educated in English and that most learners would like to be taught in English. While there is no systematic research evidence, it is also widely held that many schools with an African student body choose to use English as a language of learning and teaching (LoLT) from the first year of schooling (Taylor & Vinjevoold, 1999). The TIMSS results in South Africa were very poor. Studies that have emerged from TIMSS argue that the solution to improving African learners'

performance in mathematics is to develop their English language proficiency (e.g. Howie, 2002). What does this recommendation mean for mathematics learning?

The work on language and power is complex, not well developed in mathematics education and often misrepresented. To put this debate in perspective it is important to provide a brief overview on the political role of language.

## **LANGUAGE, POWER AND MATHEMATICS LEARNING AND TEACHING**

Previously I have argued that language is always political and therefore decisions about which language to use in multilingual mathematics classrooms, how, and for what, are not only pedagogic but also political (Setati, 2003; 2005a). The political nature of language is not only evident at the macro-level of structures but also at the micro-level of classroom interactions. Language can be used to exclude or include people in conversations and decision-making processes. Zentella (1997) through her work with Puerto Rican children in El Bario, New York shows how language can bring people together or separate them. Language is one way in which one can define one's adherence to group values.

In this paper, I use the work of Gee (1996, 1999) to explain the language choices of learners in multilingual mathematics classrooms beyond the pedagogic and cognitive. When people speak or write they create a political perspective; they use language to project themselves as certain kinds of people engaged in certain kinds of activity (Gee 1996; 1999). Language is thus never just a vehicle to express ideas but it is also used to enact a particular 'who' (identity) engaged in a particular 'what' (situated activity).

Gee uses the theoretical construct of cultural models to explore the identities and activities that people are enacting. Cultural models are shared, conventional ideas about how the world works, which individuals learn by talking and acting with their fellows. They help us explain why people do things in the way that they do and provide a framework for organizing and reconstructing memories of experience (Holland and Quinn, 1987). Cultural models do not reside in people's heads, but they are embedded in words, in people's practices and in the context in which they live. The question that is relevant for this paper is what cultural models do teachers and learners in multilingual mathematics classrooms enact in relation to language and mathematics? In what follows I use the notion of cultural models to explore why learners prefer the language(s) that they choose for learning and teaching mathematics. Thereafter I will look at the implications of such language choices for research and practice.

## **LEARNERS' LANGUAGE CHOICES**

The data used here is drawn from a wider study still in process which involves secondary school learners. I analyse individual interviews with five Grade 11 (16-year-old) learners from Soweto, the largest and most multilingual African township in South Africa with a population of about 3 million people. All of these learners are multilingual (they speak four or more languages) and learn mathematics in English,

which is not their home language. They chose their preferred language for the interview. With the exception of one (Basani), all their schooling has been in Soweto. They all made a choice to do mathematics and indicated that they like doing mathematics. Three indicated that they prefer to be taught mathematics in English while the other two felt that it really does not matter what language mathematics is learned in.

For the learners who preferred to be taught English (Tumi, Siphon and Nhlanhla) the cultural model of *English as an international language*, which positions English as the route to success, emerged as dominant in their discourse. Their preference for English is because of the social goods that come with the ability to communicate in English.

Tumi: English is an international language, just imagine a class doing maths with Setswana for example, I don't think it's good.

Researcher: Why?

Tumi: I don't think it is a good idea. Let's say she taught us in Setswana, when we meet other students from other schools and we discuss a sum for instance and she is a white person. I only know division in Setswana, so I must divide this by this and don't know English, then he I going to have problem. So I think we should talk English. English is okay.

Tumi sees English as an obvious language for learning and teaching mathematics. It is unimaginable to him for mathematics to be taught in an African language like Setswana. The use of English as a language of learning and teaching mathematics is common sense to him; he cannot imagine mathematics without English. This resonates with the teachers' cultural models above, which are exacerbated by the fact that mathematics texts and examinations are in English. Another factor that emerges in Tumi's views above is the fact that he wants to be taught mathematics in English so that he can be able to talk about mathematics in English with white people.

Siphon: I prefer that ba rute ka English gore ke tlo ithuta ho bua English. If you can't speak English, there will be no job you can get. In an interview, o thola hore lekgowa ha le kgone ho bua Sesotho or IsiZulu, ha o sa tsebe English o tlo luza job. (*I prefer that they teach us in English so that I can learn English. If you can't speak English, there will be no job you can get. In an interview you will find a white person not able to speak Sesotho or IsiZulu, you will lose the job because you don't know English.*)

Siphon's preference for English is because he sees it as a language that gives access to employment. Siphon also connects employment with white people by arguing that during the interview one must be able to express oneself in English because white people conduct interviews. This connection of jobs to white people and English is as a result of the socio-political history of South Africa in which the economy was and still continues to be in the hands of white people with English as the language of commerce, hence Siphon's expectation that a job interview will be conducted by a white person in English. Like Gugu, Tumi and Siphon see the mathematics class as an opportunity for them to gain access to English - the language of power.

Unlike Tumi and Sipho, Nhlanhla, who also indicated a preference for English, positioned herself in relation to mathematics. Nhlanhla, however, had conflicting cultural models.

Nhlanhla: ...is the way it is supposed to be because English is the standardized and international language.

Researcher: Okay, if you had a choice what language would you choose to learn maths in.

Nhlanhla: For the sake of understanding it, I would choose my language. But I wouldn't like that [English as language of learning and teaching] to be changed because somewhere somehow you would not understand what the word 'transpose' mean, ukhithi uchinchela ngale (*that you change to the other side*), some people wont understand. They would not understand what it means to change the sign and change the whole equation.

While Nhlanhla recognises the value of learning maths in a language that she understands better, she does not want English as LoLT to change because English is international and the African languages do not have a well-developed mathematics register. There are conflicting cultural models at play here: one that values the use of African languages for mathematical understanding and another that values English because of its international nature.

Researcher: What if there are students who want to learn mathematics in Zulu, what would say to them?

Nhlanhla: I would say its okay to have it but you have to minimize it because these days everything is done in English especially maths, physics and biology.

Researcher: Why does maths, physics and biology have to be done in English?

Nhlanhla: I don't know, think that's the way it is.

Nhlanhla's conflicting cultural models are evident in the above extract. They are indicative of the multiple identities that she is enacting. As a multilingual learner who is not fully proficient in English, she does not want to loose the social goods that come with English. As a mathematics learner it is important for her that she has a good understanding of mathematics and using her language, as she says, facilitates understanding. A recent study shows that while the teachers also experience conflicting cultural models, theirs are about access to social goods and not to mathematics (Setati, 2005b).

Basani and Lehlohonolo are the two learners who felt that it really does not matter what language is used for mathematics. As indicated earlier, Basani is new in the school. Before coming to the school in Soweto, he was a student at a suburban school, which was formerly for whites only. At the time of the study, it was his second year at the Soweto school, which he came to because his mother could no longer afford the fees at the former white school. Basani's level of English fluency was clearly above all the other learners interviewed. During the interview, he explained that he was doing Grade 11 for the second time because he failed IsiZulu

and Mathematics the previous year. He however insisted that he has no problem with mathematics and that he failed mathematics because he was not as focused as he should have been.

Basani: Maths is also a language on its own, it doesn't matter what language you teaching it. It depends if the person is willing to do it.

Researcher: What would you say to learners who want to be taught maths in their African languages?

Basani: I would not have problem. If that's the way they wanna do it , well its their choice. I have a friend here at school he is Sotho, I help him with Maths. Sometimes when I explain in Sesotho he doesn't understand and when I explain it in English he understands.

Researcher: why is that?

Basani: I don't know that's something I cannot answer because, how should I know, I never had a problem with maths before.

As the above extract shows, Basani believes that mathematics is a language and thus it does not make any difference what language it is taught and learned in. Basani is very confident about his mathematical knowledge and seems to be working with a cultural model that says, the key to mathematics learning is the willingness to do it. Lehlohonolo, who is also very confident about his mathematical knowledge, also felt that it does not matter what language is used for mathematics. The class teacher explained that he is the best performing learner in mathematics in his class. Another interesting thing is that when I gave them the information letters and consent forms to participate in the study, Lehlohonolo immediately indicated that I should use his real name because he wants to be famous. During the interview, Lehlohonolo focused more on mathematics rather than language.

Researcher: Does it matter which language you do maths in?

Lehlohonolo: To me it doesn't matter just as long as I am able to think in all languages and I can speak and write in those languages then I can do maths in those languages.

Lehlohonolo is connecting language to learning in very sophisticated ways. For him fluency in a language (ability to read, speak, write and think) facilitates ability to learn in the language. As he explains below, fluency in a language is not sufficient to make a learner successful in mathematics.

Lehlohonolo: What I have realized is students that are I go with in class fail maths but they do well in English, I don't think English is the cause of why they failing maths. Some of them they chose maths because of their friends, some of them are in the wrong class. From my past experience they are not good in maths so they shouldn't have gone with maths. Even if you do it in IsiZulu, things will be the same, the problem is not with the language. They don't want to think, they don't want to be active; they don't interact with the teacher. If the teacher does the exercise and ask them if they are okay with this, they just agree, but when it comes to writing they don't understand.

For Lehlohonolo, language cannot be blamed for failure or given credit for success in mathematics. He sees the important factor in succeeding in mathematics as being the learners themselves and the choices they make about how they participate in the mathematics class. The above extract suggests that Lehlohonolo enacts a cultural model that mathematics should be taken only by those who are good at it and being good at mathematics is not connected to language.

Researcher: So if you had a group of students who want to do maths in Zulu, what would you say to them?

Lehlohonolo: That's their own problem because if they out of high school, they cannot expect to find an Indian lecturer teaching maths in Zulu. English is the simplest language that everyone can speak so they will have to get used to English whilst they are still here.

While Lehlohonolo does not connect failure or success in mathematics to language, in the above extract he seems to be suggesting that learners should choose to learn in English because in higher education no lecturer will be able to teach in their languages. This is an emergence of a conflicting cultural model for Lehlohonolo, which says even if there is no causal link between success in mathematics and the language used for learning and teaching, English cannot be ignored.

The above discussion shows that the learners who prefer to be taught in English position themselves in relation to English. Nhlanhla is the only one who preferred English and also positioned herself in relation to mathematics. Tumi and Siphon are more concerned with gaining fluency in English so that they can access social goods such as jobs and higher education. They enact the cultural model that *English is international*.

A recent analysis of teachers' language choices shows that they prefer English to be the language of learning and teaching mathematics (Setati, 2005b). Teachers are aware of the linguistic capital of English and the symbolic power it bestows on those who can communicate in it. They see their role as that of preparing their learners for participation in the international world, and teaching mathematics in English is an important part of this preparation. A glaring absence in the teachers' interviews was any reference to how learning and teaching in English as they prefer, would facilitate the learners' access to mathematics (epistemological access) for the learners. This absence suggests that the teachers position themselves in relation to English and not mathematics. What is more prevalent in the reasons for preference of English are: economic, political and ideological factors.

The preference for English highlights the belief that the acquisition of the English language constitutes the major content of schooling. This is inconsistent with the content of schooling, which is about giving epistemological access and to research and the Language in Education Policy (LiEP) in South Africa, which promotes multilingualism and encourages use of the learners' home language. The assumption embedded in this policy is that mathematics teachers and learners in multilingual classrooms together with their parents are somehow free of economic, political and

ideological constraints and pressures when they apparently freely opt for English as LoLT. The LiEP seems to be taking a structuralist and positivist view of language, one that suggests that all languages can be free of cultural and political influences.

As indicated earlier, the learners who position themselves in relation to the mathematics seem to be working with conflicting cultural models – one that is about mathematical understanding and the other that is about English fluency.

### **WHAT DOES THIS MEAN FOR RESEARCH AND PRACTICE?**

Research argues that to facilitate multilingual learners' participation and success in mathematics teachers should recognise their home languages as legitimate languages of mathematical communication (Khisty, 1995; Moschkovich, 1999, 2002; Setati & Adler, 2001). The analysis presented in this paper shows that the language choices of teachers and learners who prefer English are informed by the political nature of language. The challenge is in bringing the two together. Research shows that in bringing the two together, English dominates.

A recent detailed analysis of a lesson taught by primary school teacher suggested a relationship between the language(s) used, mathematics discourses and cultural models that emerged (Setati, 2005a). During the lesson, the teacher switched between English and Setswana. However, her use of English was accompanied by procedural discourse while her use of Setswana was accompanied by conceptual discourse. While it can be argued that the observations made in this teacher's classroom cannot be generalised to all the teachers in multilingual classrooms, they give us an idea of what the dominance of English in multilingual mathematics classrooms can produce.

Recent research in South Africa points to the fact that procedural teaching is dominant in most multilingual classrooms (Taylor and Vinjevod, 1999). In most cases, this dominance of procedural teaching is seen as being a function of the teachers' lack of or limited knowledge of mathematics. What the above discussion suggests is that the problem is much more complex.

### **CONCLUSION**

The analysis presented in this paper shows that teachers and learners who position themselves in relation to English are concerned with access to social goods and positioned by the social and economic power of English. They argue for English as LoLT. Issues of epistemological access are absent in their discourse. In contrast, learners who position themselves in relation to mathematics and so epistemological access, reflect more contradictory discourses, including support for the use of the learners' home languages as LoLT. The work presented in this paper provides an important contribution in dealing with the complex issues related to teaching and learning in multilingual classrooms. Much remains to be done.

### **References**

Gee, J. P. (1996). *Social Linguistics and Literacies: Ideology in Discourses*. London: Falmer Press, Taylor and Francis group.

- Gee, J. P. (1999). *An Introduction to Discourse Analysis: Theory and Method*. London: Routledge.
- Holland, D., & Quinn, N. (Eds.). (1987). *Cultural Models in Language and Thought*. Cambridge: Cambridge University Press.
- Howie, S. (2002). *English Language Proficiency and Contextual Factors Influencing Mathematics Achievement of Secondary School Pupils in South Africa*. Den Haag: CIP-Gegevens Koninklijke Bibliotheek.
- Khisty, L. L. (1995). Making inequality: Issues of language and meaning in mathematics teaching with Hispanic students. In W. G. Secada, E. Fennema, & L. B. Abajian (Eds.), *New Directions for equity in mathematics education*. (pp. 279-297). Cambridge: Cambridge University Press.
- Moschkovich, J. (1999). Supporting the participation of English language learners in mathematical discussions. *For the Learning of Mathematics*, 19(1), 11 - 19.
- Moschkovich, J. (2002). A situated and sociocultural perspective on bilingual mathematics learners. *Mathematical Thinking and Learning*. 4(2 & 3), 189 – 212.
- Setati, M. (2003). Language use in a multilingual mathematics classroom in South Africa: A different perspective. In L. Pateman, B. Dougherty & J. Zilliox (Eds.) *Proceedings of the 2003 Joint meeting of PME and PMENA*. Pp. 151 – 158. Honolulu: University of Hawai'i.
- Setati, M., & Adler, J. (2001). Between languages and discourses: Language practices in primary multilingual mathematics classrooms in South Africa. *Educational Studies in Mathematics*, 43(3), 243 - 269.
- Setati, M. (2005a). Teaching mathematics in a primary multilingual classroom. *Journal for Research in Mathematics Education*. 36(5) pp. 447 – 466.
- Setati, M. (2005b). Power and access in Multilingual mathematics classrooms. In M. Goos, C. Kanen and R. Brown. *Proceedings of the 4<sup>th</sup> International Mathematics Education and Society Conference*. Australia: Centre for Learning Research, Griffith University.
- Taylor, N., & Vinjevold, P. (1999). *Getting Learning Right*. Johannesburg: Joint Education Trust.
- Zentella, A. C. (1997). *Growing up bilingual: Puerto Rican children in New York*. Malden, MA: Blackwell.



# COMPARTMENTALIZATION OF REPRESENTATION IN TASKS RELATED TO ADDITION AND SUBTRACTION USING THE NUMBER LINE

Myria Shiakalli\*, Athanasios Gagatsis\*\*

\* Primary School Teacher, PhD in Mathematics Education

\*\* Department of Education, University of Cyprus

*The present paper aims at identifying the difficulties that arise in the conversion from one mode of representation of the concepts of addition and subtraction to another, and examining the phenomenon of compartmentalization, i.e. deficiency in the coordination of at least two modes of representation of a concept. Three tests were administered to 231 first and 241 second grade students. All the tests consisted of the same addition and subtraction tasks, but differed in the types of conversions that they involved. Data analysis showed lack of connections among the tasks of the three tests for both age groups. This finding reveals that different types of conversions among representations of the same mathematical content were approached in a distinct way, indicating the existence of the phenomenon of compartmentalization.*

## INTRODUCTION

Representations are used extensively in mathematics and translation ability is highly correlated with success in mathematics education. Mathematics teaching, school textbooks and other teaching materials in mathematics submit children to a wide variety of representations. The representational systems are fundamental for conceptual learning and determine, to a significant extent, what is learnt (Cheng, 2000). Understanding an idea entails (a) the ability to recognise an idea, which is embedded in a variety of qualitatively different representational systems; (b) the ability to flexibly manipulate the idea within given representational systems and (c) the ability to translate the idea from one system to another accurately (Gagatsis & Shiakalli, 2004). This is due to the fact that a construct in mathematics is accessible only through its semiotic representations and in addition one semiotic representation by itself cannot lead to the understanding of the mathematical object it represents (Duval, 2002). Understanding any concept entails the ability to coherently recognise at least two different representations of the concept and the ability to pass from the one to the other without falling into contradictions (Duval, 2002; Gagatsis, & Shiakalli, 2004; Griffin, & Case, 1997). Kaput (1992) found that translation disabilities are significant factors influencing mathematical learning. Strengthening or remediating these abilities facilitates the acquisition and use of elementary mathematical ideas. To diagnose a student's learning difficulties or to identify instructional opportunities teachers can generate a variety of useful kinds of questions by presenting an idea in one representational mode and asking the student to illustrate, describe or represent the same idea in another mode. A central goal of mathematics teaching is thus taken to be that the students be able to pass from one

representation to another (Hitt, 1998; Janvier, 1987). Despite this fact, many studies have shown that students face difficulties in transferring information gained in one context to another (e.g., Gagatsis, Shiakalli, & Panaoura, 2003; Yang, & Huang, 2004).

In this paper, the term representations, in a restricted sense, is interpreted as the tools used for representing mathematical ideas (Gagatsis, Elia, & Mougi, 2002). By translation or conversion process, we refer to the psychological process involving the moving from one mode of representation to another (Janvier, 1987). The ability to identify and represent the same concept in different representations, and flexibility in moving from one representation to another, are crucial in mathematics learning, as they allow students to see rich connections, and develop deeper understanding of concepts (Even, 1998).

Difficulties in the translation from one mode of representation of the same concept to another and inability to use a variety of representations for a mathematical idea can be seen as an indication for the existence of compartmentalization. The particular phenomenon reveals a cognitive difficulty that arises from the need to accomplish flexible and competent translation back and forth between different kinds of mathematical representations (Duval, 2002). The focus of the present study is to identify the difficulties that arise in the conversion back and forth between the symbolic and the number line representation of the concepts of addition and subtraction and to examine the phenomenon of compartmentalization, which may affect mathematics learning in a negative way.

What is usually meant by the number line as a didactic means is a straight line with a scale, which is used for representing and carrying out arithmetic operations. Some researchers in mathematics education consider the number line to be (a) an important manipulative, that is a concrete model that students can use as a visual aid to solve mathematical problems (Hegarty, & Kozhevnikov, 1999; Raftopoulos, 2002); (b) a critical component in teaching arithmetic in general (Klein, Beishuizen, & Treffers, 1998; Selter, 1998) and the ordinal aspects of number. Related research explores the conditions under which the number line can enhance arithmetic understanding in first and second grade students (Fueyo, & Bushell, 1998; Klein et al., 1998). The effectiveness of the number line in helping students improve their performances in whole number addition and subtraction tasks, is, however questioned by other researchers in the field (Ernest, 1985; Hart, 1981; Liebeck, 1984).

Previous empirical studies have not clarified compartmentalization in a comprehensive or systematic way. The existence of this phenomenon in students' behaviour could not be revealed or verified by students' success rates neither by students' protocols in tasks involving different representations. These types of data can just be considered as an indication of the existence of compartmentalization. Thus, we theorize that the Factor Analysis along with the Implicative Statistical Method of Analysis, which reveals the similarity connections between students' responses in the administered tasks, can be beneficial for identifying the existence of compartmentalization in students' behaviour. Our basic conjecture is that

compartmentalization exists when the following conditions appear: First, students deal inconsistently or incoherently with different types of translation of the same mathematical knowledge from one mode of representation to another; and second, success in one mode of representation or type of conversion of a concept does not entail success in another mode of representation or type of conversion of the same concept. The basic hypotheses of the present paper, which is part of a larger research study (Shiakalli, 2004), are the following: (a) There is a compartmentalization of addition and subtraction tasks in symbolic representation without the use of the number line and of the corresponding number line addition and subtraction tasks; (b) There is a statistically significant difference in the performance of first and second grade students according to the direction of the translation – from the symbolic to the number line representation and vice-versa.

## METHOD

### Participants

In the research participated 231 first grade students – average age 6.1 – coming from 10 different classrooms and 241 second grade students – average age 7.2 – coming from 11 different classrooms. The population of the study was the number of first and second graders attending the 74 public primary schools in the Limassol district in Cyprus. The subjects came from six public primary schools.

### Research instruments

Three tests (Test A, Test B, Test C) were administered to the students, a week apart from each other. Test A includes 12 addition and 12 subtraction tasks with numbers up to 30 expressed symbolically (e.g.,  $5+3=$  \_\_\_\_,  $16-2=$  \_\_\_\_,  $19+$  \_\_\_\_  $=25$ ,  $9 -$  \_\_\_\_  $= 2$ , \_\_\_\_  $+ 2 = 8$ , \_\_\_\_  $- 3 = 14$ ). Test B includes the same tasks, but this time students had to use the number line in order to represent the given mathematical sentence, to find the answer on the number line and then to complete the mathematical sentence (translation from the symbolic representation – mathematical sentence to the number line representation). For example,  $5 + 3 =$  \_\_\_\_

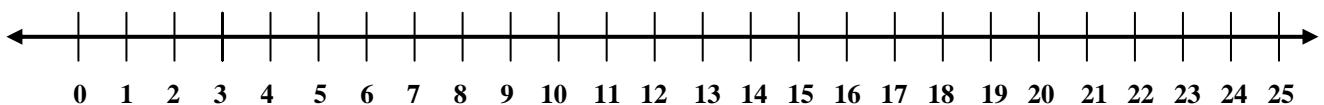

Test C includes the same tasks, however, students had to write the mathematical sentence represented on the number line (translation from the number line representation to the symbolic representation).

### Data analysis

The Factor Analysis, the Repeated Measures Analysis and the Implicative Statistical Method of Gras using a computer software called C.H.I.C. (Classification Hiérarchique Implicative et Cohésive) (Bodin, Coutourier, & Gras, 2000) were used for the analysis of the collected data based on students' performance in the tasks. Gras's Implicative Statistical Model is a method of analysis that determines the similarity connections of factors (Gras, 1996). For this study's needs, similarity diagrams were produced for each age group of students. The similarity diagram

allows for the arrangement of the tasks into groups according to the homogeneity by which they were handled by the students.

**RESULTS**

The six factors, which occurred from the Factor Analysis explaining 53% of the total variance, indicate that the addition and subtraction tasks were grouped based on the type of representation. Factor 1 is related to the symbolic representation tasks (tasks included in Test A), Factor 6 is related to the easy symbolic representation tasks (tasks included in Test A), Factor 4 is related to the translation tasks from the symbolic representation to the number line representation (tasks included in Test B), Factor 5 is related to the easy translation tasks from the symbolic representation to the number line representation (tasks included in Test B), whereas Factor 3 is related to translation tasks from the number line representation to the symbolic representation (tasks included in Test C). Only Factor 2 is related to symbolic representation tasks as well as to translation tasks from the symbolic representation to the number line representation. In this case, the grouping of the variables was based on the difficulty of the tasks, which is attributed to the place of the unknown quantity (initial quantity is unknown) and not based on the type of the representation.

The results from the Factor Analysis are reinforced by the results from the Implicative Statistical Method of Analysis. Figure 1 presents the Similarity Diagram (Lerman, 1981) of the addition and subtraction tasks in Test A (symbolic representation) and Test C (number line representation) according to the second graders' responses.

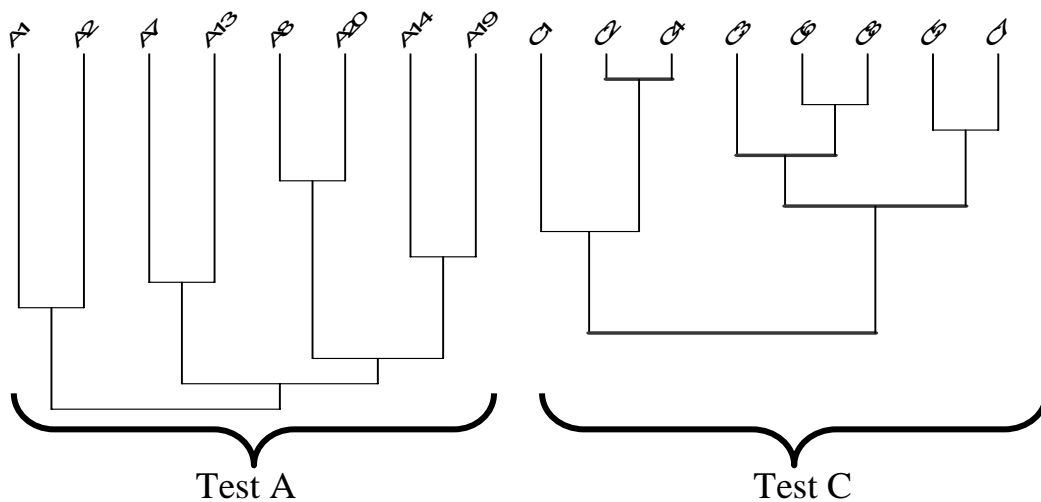

Figure 1: Similarity diagram of second grade students' responses in Test A and Test C

Similarities presented with bold lines are important at significant level 99%. Two distinct similarity groups of tasks are identified in Figure 1. The first group involves similarity relations among the tasks of Test A, while the second group involves similarity relations among the tasks of Test C. This finding reveals that the mode of representation (symbolic representation, number line representation), seems to influence students' performance, even though the tasks involved the same algebraic

relations. The same conclusion can be drawn from the Similarity Diagram of first grade students' responses in Test A and Test C (Shiakalli, 2004).

The results from the Repeated Measures Analysis showed that the performance of first and second graders differs according to the direction of the translation – symbolic to the number line representation (tasks in Test B) or vice-versa (tasks in Test C). The mean of the performance of first graders at translation tasks from the symbolic to the number line representation is 4.242, whereas the mean of their performance at translation tasks from the number line representation to the symbolic representation is 5.052. The mean of the performance of second graders at translation tasks from the symbolic to the number line representation is 4.207, whereas the mean of their performance at translation tasks from the number line representation to the symbolic representation is 5.589. The performance of first and second graders is higher at translation tasks from the number line to the symbolic representation (tasks in Test C) when compared to their performance at translation tasks from the symbolic to the number line representation (tasks in Test B) ( $<0.05$ ). The results from the Repeated Measures Analysis are reinforced by the results from the Implicative Statistical Method of Analysis presented in the Similarity Diagrams of first and second grade students' responses in Tests B and C (Shiakalli, 2004). This finding reveals that different types of conversions among representations of the same mathematical content were approached in a completely distinct way. The mode of representation along with the type of the conversion (translation from the symbolic to the number line representation or vice-versa), seem to influence students' performance, even though the tasks involved the same algebraic relations.

## **DISCUSSION**

Based on the results derived from the Factor Analysis, the Repeated Measures Analysis and the Implicative Statistical Method of Analysis there appears to be a compartmentalization of the addition and subtraction tasks in symbolic form and diagrammatic form (number line). Despite the fact that we have proposed the same addition and subtraction tasks in symbolic representation and in number line representation, the tasks are grouped based on the type of representation. This indicates that there is no relationship between the two representations of the concepts of addition and subtraction – the symbolic representation and the number line representation. First and second grade students do not realize that the two different representations are just different expressions of the same concept.

It is evident that there is no relationship between first and second grade students' ability to perform whole number addition and subtraction operations with the use of the number line and their ability to perform these tasks in symbolic representation. The successful or unsuccessful use of the number line in performing whole number addition or subtraction tasks is not an indication of understanding or lack of understanding of these operations (Shiakalli, 2004; Shiakalli, & Gagatsis, 2005). According to the results, it seems that first as well as second graders are able to solve whole number addition or subtraction tasks expressed symbolically, whereas they

face difficulties in understanding and using the addition and subtraction number line model.

The aim of the present study was to identify and investigate the phenomenon of compartmentalization as regards the understanding of the concepts of addition and subtraction. There was a congruent structure of the similarity diagrams for both age groups, indicating that the phenomenon of compartmentalization exists irrespective of students' age. Lack of connections among different types of representation and different types of conversion of the same mathematical content is the main feature of the phenomenon of compartmentalization and indicates that students of both age groups did not construct the whole meaning of the concepts of addition and subtraction and did not grasp the whole range of their applications. As Even (1998) supports, the ability to identify and represent the same concept in different representations, and flexibility in moving from one representation to another allow students to see rich relationships, and develop deeper understanding of the concept. This inconsistent behaviour can also be seen as an indication of the students' conception that different representations of the same concept are completely distinct and autonomous mathematical objects and not just different ways of expressing the meaning of a particular notion. In other words, students may have confused the mathematical objects of addition and subtraction with their semiotic representation (Duval, 2002).

The differences among students' scores in the various conversions from one representation to another, referring to the same addition or subtraction task provide support to the above findings as well as to the different cognitive demands and distinctive characteristics of different modes of representation. A translation involves two modes of representation: the source (initial representation) and the target (final representation) (Janvier, 1987). According to Janvier (1987), to achieve directly and correctly a given translation, one has to transform the source target-wise or, in other words, to look at it from a target point of view and derive the results. For example, students' greater difficulty in carrying out a conversion from the symbolic representation to the number line representation (tasks in Test B) than carrying out a translation from the number line representation to the symbolic representation (tasks in Test C), may be due to the fact that perceptual analysis and synthesis of mathematical information presented implicitly in a diagram often make greater demands on a student than any other aspect of a problem (Aspinwall, Shaw, & Presmeg, 1997; Gagatsis, & Shiakalli, 2004).

This phenomenon of compartmentalization is a strong indication that learning in this domain is not achieved because, as Duval (2002) claims learning can be accomplished only through "de-compartmentalization". It is worthwhile to note that students' difficulties in working with number line seem to be independent of the students' culture, language and the teaching of mathematics that they received. In fact, as the research of Gagatsis, Kyriakides and Panaoura (2004) showed, the assessment of the applicability of number line in conducting arithmetic operations in Cypriot, Italian and Greek primary pupils follows the same structural model. From

this perspective it would be interesting to examine and compare the phenomenon of compartmentalization across students of different countries.

## References

- Aspinwall, L., Shaw, K. L., Presmeg, N. C. (1997). Uncontrollable mental imagery: Graphical connections between a function and its derivative. *Educational Studies in Mathematics*, 33, 301-317.
- Bodin, A., Coutourier, R., & Gras, R. (2000). *CHIC : Classification Hiérarchique Implicative et Cohésive-Version sous Windows – CHIC 1.2*. Rennes : Association pour la Recherche en Didactique des Mathématiques.
- Cheng, P.C.H. (2000). Unlocking conceptual learning in mathematics and science with effective representational systems. *Computers and Education*, 33, 109-130.
- Duval, R. (2002). The cognitive analysis of problems of comprehension in the learning of mathematics. *Mediterranean Journal for Research in Mathematics Education*, 1 (2), 1-16.
- Ernest, P. (1985). The number line as a teaching aid. *Educational Studies in Mathematics*, 16 (4), 411-424.
- Even, R. (1998). Factors involved in linking representations of functions. *The Journal of Mathematical Behavior*, 17 (1), 105-121.
- Fueyo, V., & Bushell, D. Jr. (1998). Using number line procedures and peer tutoring to improve the mathematics computation of low-performing first graders. *Journal of Applied Behavior Analysis*, 31 (3), 417-430.
- Gagatsis, A., Shiakalli, M., & Panaoura, A. (2003). La droite arithmétique comme modèle géométrique de l' addition et de la soustraction des nombres entiers. *Annales de Didactique et de Sciences Cognitives*, 8, 95-112.
- Gagatsis, A., & Shiakalli, M. (2004). Ability to translate from one representation of the concept of function to another and mathematical problem solving. *Educational Psychology*, 24 (5), 645-657.
- Gagatsis, A., Elia, I., & Mougi, A. (2002). The nature of multiple representations in developing mathematical relations. *Scientia Paedagogica Experimentalis*, 39 (1), 9-24.
- Gagatsis, A., Kyriakides, L., & Panaoura, A. (2004). Assessing the cross-cultural applicability of number lines in conducting arithmetic operations using structural equation modeling : A comparative study between Cypriot, Italian and Greek primary pupils. *World Studies in Education*, 5(1), 85-101.
- Gras, R. (1996). *L'implication statistique. Collection associée à Recherches en Didactique des Mathématiques*. Grenoble: La Pensée Sauvage.
- Griffin, S., & Case, R.(1997). Re-thinking the primary school math curriculum: an approach based on cognitive science. *Issues in Education*, 3(1), 1-49.
- Hart, K. M. (Ed.) (1981). *Children's understanding of mathematics*. London: John Murray.
- Hegarty, M., & Kozhevnikov, M. (1999). Types of visual-spatial representations and mathematical problem solving. *Journal of Educational Psychology*, 19, 684-689.

- Hitt, F. (1998). Difficulties in the articulation of different representations linked to the concept of function. *The Journal of Mathematical Behavior*, 17 (1), 123-134.
- Janvier, C. (1987). Translation processes in mathematics education. In C. Janvier (Ed.), *Problems of representation in the teaching and learning of mathematics* (pp. 27-32), Hillsdale, NJ: Lawrence Erlbaum.
- Kaput, J. (1992). Technology and mathematics education. In D. A. Grouws (Ed.), *Handbook of research on mathematics teaching and learning* (pp. 515-556). New York: Macmillan.
- Klein, A. S., Beishuizen, M., & Treffers, A. (1998). The empty number line in Dutch second grades: Realistic versus gradual program design. *Journal for Research in Mathematics Education*, 29 (4), 443-464.
- Lerman, I.C. (1981). *Classification et analyse ordinale des données*. Paris: Dunod.
- Liebeck, P. (1984). *How children learn mathematics*. Harmondsworth: Penguin.
- Raftopoulos, A. (2002). The spatial intuition of number and the number line. *Mediterranean Journal for Research in Mathematics Education*, 1 (2), 17-36.
- Selter, Ch. (1998). Building on children's mathematics – A teaching experiment in grade three. *Educational Studies in Mathematics*, 36, 96-121.
- Shiakalli, M., & Gagatsis, A. (2005). The number line as a geometrical model for teaching whole number addition and subtraction. In A. Gagatsis, F. Spagnolo, Gr. Makrides, & V. Farmaki (Eds.), *Proceedings of the 4<sup>rd</sup> Mediterranean Conference on Mathematical Education*, (Vol. II, pp. 329-340). Palermo: University of Palermo, Cyprus Mathematical Society, MATHEU Project (Socrates-Comenius).
- Shiakalli, M. (2004). The number line as a geometrical model for the teaching of whole number addition and subtraction: Research with first and second graders. *Unpublished PhD Thesis* (in Greek).
- Yang, D., & Huang, F. (2004). Relationships among computational performance, pictorial representation, symbolic representation and number sense of sixth-grade students in Taiwan. *Educational Studies*, 30 (4), 373-389.



# THE DERIVATION OF A LEARNING ASSESSMENT FRAMEWORK FOR MULTIPLICATIVE THINKING

Dianne Siemon John Izard Margarita Breed Jo Virgona

RMIT University

*Research has shown that many students in Years 5 to 9 experience considerable difficulty with rational number, algebra, and the application of multiplication and division to a broader range of problem types. While each of these has been the focus of considerable research, there is little advice about how these ideas are connected and jointly develop over time. This paper describes the genesis of a learning assessment framework for multiplicative thinking based on Rasch analysis of student responses to a range of rich tasks to inform more targeted approaches to teaching mathematics in the middle years.*

## INTRODUCTION

The purpose of this paper is to share some of the findings from a current research project aimed at scaffolding numeracy learning in the middle years of schooling. The project was prompted by the results of an earlier study which indicated that many students in Years 5 to 9 have difficulty with what might broadly be described as multiplicative thinking. That is, thinking that is characterised by (i) a capacity to work flexibly and efficiently with an extended range of numbers (for example, larger whole numbers, decimals, common fractions, and/or per cent), (ii) an ability to recognise and solve a range of problems involving multiplication or division including direct and indirect proportion, and (iii) the means to communicate this effectively in a variety of ways (for example, words, diagrams, symbolic expressions, and written algorithms). In particular, the results suggest that while most students are able to solve multiplication problems involving relatively small whole numbers they rely on additive strategies to solve more complex multiplicative problems involving larger whole numbers, rational numbers, and/or situations not easily modelled in terms of equal groups (Siemon & Virgona, 2001). This suggests that the transition from additive to multiplicative thinking is nowhere near as smooth or as straightforward as most curriculum documents seem to imply, and that access to multiplicative thinking as it is described here represents a real and persistent barrier to many students' mathematical progress in the middle years of schooling.

This observation is supported by research more generally. For example, there is a considerable body of research pointing to the difficulties students experience with multiplication and division (Mulligan & Mitchelmore, 1997; Anghileri, 1999), and the relatively long period of time needed to develop these ideas (Clark & Kamii, 1996; Sullivan, Clarke, Cheeseman & Mulligan, 2001). Student's difficulties with rational number and proportional reasoning have also been well documented (for example, Hart, 1981; Harel & Confrey, 1994; Lamon, 1996; Baturo, 1997;

Misailidou & Williams, 2003). Moreover, there is a growing body of research documenting the link between multiplicative thinking and rational number ideas (Harel & Confrey, 1994; Baturu, 1997); multiplicative thinking and spatial ideas (Battista, 1999), and the importance of both as a basis for understanding algebra (Gray & Tall, 1994). While this work contributes to a better understanding of the ‘big ideas’ involved, very little is specifically concerned with how these ideas relate to one another and which aspects might be needed when, to support new learning both within and between these different domains of multiplicative thinking. Moreover, very little of this work appears to be represented in a form and language that directly translates to practice in the middle years of schooling.

Ball (2000) identified three problems that need to be solved if we are “to prepare teachers who not only know content but can make use of it to help all students learn” (p.6). First, she suggests, we need to re-examine what content knowledge matters for good teaching. Second, we need to understand how subject matter must be understood to be useable in teaching (pedagogical content knowledge), and thirdly we need “to create opportunities for learning subject matter that would enable teachers not only to know, but to learn to use what they know in the varied contexts of practice” (p.8). Simon’s (1995) idea of constructing hypothetical learning trajectories as mini-theories of student learning in particular domains appears to offer a useful approach to these problems as they provide an accessible framework for identifying where students ‘are at’ and offer starting points for teaching.

In Australia, learning trajectories have tended to take the form of learning and assessment frameworks which have been developed and validated in terms of a number of discrete domains such as counting, place-value, and addition in the early years of schooling (Clarke, Sullivan, Cheeseman & Clarke, 2000). While learning and assessment frameworks for multiplication and division have been developed at this level, the evidence suggests that very few students in Years P to 3 are at the point of abstracting multiplicative thinking, that is, able to work confidently and efficiently with multiplicative thinking in the absence of physical models (Mulligan & Mitchelmore, 1997; Sullivan et al., 2001). Where teachers were supported to identify and interpret student learning needs in terms of the frameworks, it was shown that they were more informed about where to start teaching, and better able to scaffold their students’ mathematical learning (Clarke, 2001). This suggests that clarifying and extending the key ideas involved in multiplicative thinking and working with teachers to identify student learning needs and plan targeted teaching interventions, is likely to contribute to enhanced learning outcomes for students in the middle years.

## **THE PROJECT**

The research reported in this paper is a key part of a larger study aimed at investigating the efficacy of a new assessment-guided approach to improving student numeracy outcomes in Years 4 to 8. In particular, it is concerned with documenting the development of multiplicative thinking which is known to be a major barrier to students’ mathematical progress in the middle years. The research is premised on the

view that where teachers have a clear understanding of learning trajectories and where students 'are at' in terms of those trajectories, they are better able to make informed decisions about what targets to set and how to achieve them. A major component of the research study was the identification of an evidence-based learning and assessment framework which could be used to support a more targeted approach to the development of multiplicative thinking in the middle years of schooling.

While the project was designed to address a number of research questions, the one that will be addressed here is the extent to which it is possible to identify and validate an integrated learning assessment framework for multiplicative thinking that relates to and builds on what is known in the early years.

## METHOD:

The research plan was designed in terms of three overlapping phases. Phase 1 was aimed at identifying a broad hypothetical learning trajectory (HLT) which would form the basis of the proposed learning and assessment framework for multiplicative thinking (LAF). Phase 2 involved the design, trial and subsequent use of a range of rich assessment tasks which were variously used at the beginning and end of the project to inform the development of the LAF. Phase 3 involved research school teachers and members of the research team in an eighteen month action research study that progressively explored a range of targeted teaching interventions aimed at scaffolding student learning in terms of the LAF.

Just over 1500 Year 4 to 8 students and their teachers from three *research* school clusters, each comprising three to six primary (K-6) schools and one secondary (7-12) school, were involved in Phases 2 and 3 of the project. A similar group of Year 4 to 8 students from three *reference* school clusters was involved in Phase 2 only.

**Phase 1:** The initial HLT was derived from a synthesis of the research literature on students' understanding of multiplicative thinking, proportional reasoning, decimal place-value and rational number. It comprised nine 'levels' of increasingly complex ideas and strategies grouped together more on the basis of 'what seemed to go with what' than any real empirical evidence, although this was used where available. The HLT was then used to select, modify and/or design a range of rich tasks including at least two extended tasks (Callingham & Griffin, 2000; Siemon & Stephens, 2001). The tasks were trialled and either accepted, rejected or further modified on the basis of their accessibility to the cohort, discriminability and perceived validity in terms of the constructs being assessed. Trial data were used to develop scoring rubrics and feedback from the trial teachers was used to modify the assessment protocol.

**Phase 2:** A total of just under 3200 students in the research and reference schools completed the initial assessment tasks in May 2004. To control order effects and maximise the number of tasks that could be included, four different test booklets were prepared. Each test comprised one of two extended tasks (9 or 13 items) and five shorter tasks (2 to 4 items each). Common tasks were variously used to link the four tests. For instance, two short tasks were completed by all students, two more

were completed by 75% of the students and another two were completed by 50% of the students.

Research school teachers administered the tasks and scored these on the basis of the scoring rubrics provided. A professional development session was provided to support this process at a meeting of all research school teachers at the beginning of 2004. Reference school teachers were briefed on the purpose and administration of the tasks at a separate meeting but were not required to score students' work. This was undertaken by a group of scorers under the direction of the research team. Following this, and to support the further elaboration of some levels of the LAF particularly those hypothesised at the upper end of the framework, a number of additional tasks were developed and trialled in October 2004. The results of this exercise and the subsequent assessment of Year 7 students in March 2005 were used to inform the development of the LAF.

### Analysis

The data were analysed using Rasch (1980) measurement techniques, which allowed both students' performances and item difficulties to be measured using the same log-odds unit (the logit), and placed on an interval scale. Consistent with other studies that have used Rasch to evaluate mathematical performance, for example, Izard, Haines, Crouch, Houston and Neill (2003), Misailidou & Williams (2003) and Watson, Kelly, & Izard (2004), anchoring strategies were used to place students on a common achievement scale. The Quest computer program (Adams & Khoo, 1996) was used to apply the Partial Credit Model (Masters, 1982) and obtain a variable map showing the placement of students and items along the scale. The Quest program evaluates the fit of the data to the Rasch Model: the default acceptable values (between 0.77 and 1.3) were used to check the fit of the data to the model. The values of the Separation Reliability for both items and persons were high, indicating consistent behaviours of both items and persons.

An excerpt from the variable map produced for one version of the initial assessment tasks is shown in Figure 1. Students are shown (anonymously) on the left-hand side of the variable map (in this case, each x represents 2 students). The coded items on the right refer to a particular part of each task, for example, **pkpb.2** (highlighted in bold) refers to part b of the *Packing Pots* task. The location of the coded item indicates the point at which students scoring at this level have a 50% chance of satisfying the scoring criterion indicated by the number following the full stop (in this case, a score of 2 out of a possible 0, 1 or 2). The logit value at this point is referred to as the item threshold (in this case, -0.16).

The variable maps for each test administration were combined to produce an overall list of item thresholds which differentiated items on the basis of student performance. Easier, more accessible items had relatively low item thresholds. For example, the item threshold associated with a score of 1 for part b of the *Tables and Chairs* task (possible scores 0 or 1) was -2.69. The item threshold associated with a score of 4 on part b of the *Adventure Camp* task (possible scores 0, 1, 2, 3 or 4) was 3.53.

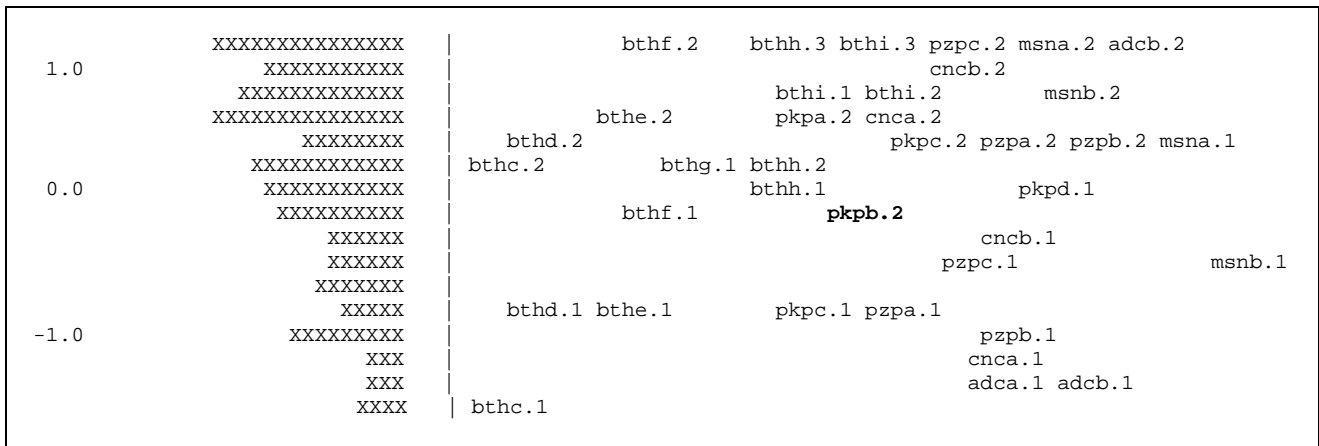

Figure 1. Excerpt from Variable Map V1 (N=358, full logit range: -3 to 4.2)

### THE FRAMEWORK

A detailed content analysis of items led to the identification of eight relatively discrete categories which described what students might be expected to be able to do if they scored within the corresponding band of item thresholds. For instance, in terms of the items shown in Figure 1, items with thresholds ranging from 0 to 0.5 were grouped together (with other items not shown on this version) to form a discrete category that might broadly be described as early multiplicative thinking (see Level 4 in Table 1 below). Students who scored within this band were generally able to solve simple 2-digit by 2-digit multiplication problems (for example, a snail travels at 15 cm/minute, how far will it travel in 34 minutes), and accurately represent and describe the results of sharing 4 pizzas among 3 and 3 pizzas among 4, but they had some difficulty interpreting remainders and justifying their responses.

Level 1: Solves simple multiplication and division problems involving relatively small whole numbers but tends to rely on drawing, models and count-all strategies. May use skip counting for groups less than 5. Makes simple observations from data and extends simple number patterns. Multiplicative thinking (MT) not really apparent as no indication that groups are perceived as composite units, dealt with systematically, or that the number of groups can be manipulated to support more efficient calculation

Level 2: Counts large collections efficiently, keeps track of count but needs to see all groups. Shares collections equally. Recognises small numbers as composite units (eg, can count equal groups, skip count by twos, threes and fives). Recognises multiplication needed but tends not to be able to follow this through to solution. Lists some of the options in simple Cartesian product situations. Some evidence of MT as equal groups/shares seen as entities that can be counted.

Level 3: Demonstrates intuitive sense of proportion. Works with useful numbers such as 2 and 5 and intuitive strategies to count/compare groups (eg, doubling, or repeated halving to compare simple fractions). May list all options in a simple Cartesian product, but cannot explain or justify solutions. Beginning to work with larger whole numbers and patterns but tends to rely on count all methods or additive thinking (AT).

<p>Level 4: Solves simple multiplication and division problems involving two-digit numbers. Tends to rely on AT, drawings and/or informal strategies to tackle problems involving larger numbers, decimals and/or less familiar situations. Tends not to explain thinking or indicate working. Partitions given number or quantity into equal parts and describes part formally. Beginning to work with simple proportion.</p>
<p>Level 5: Solves whole number proportion and array problems systematically. Solves simple, 2-step problems using a recognised rule/relationship but finds this difficult for larger numbers. Determines all options in Cartesian product situations involving relatively small numbers, but tends to do this additively. Beginning to work with decimal numbers and percent. Some evidence MT being used to support partitioning. Beginning to approach a broader range of multiplicative situations more systematically</p>
<p>Level 6: Systematically lists/determines the number of options in Cartesian product situation. Solves a broader range of multiplication and division problems involving 2-digit numbers, patterns and/or proportion but may not be able to explain or justify solution strategy. Renames and compares fractions in the halving family, uses partitioning strategies to locate simple fractions. Developing sense of proportion, but unable to explain or justify thinking. Developing capacity to work mentally with multiplication and division facts</p>
<p>Level 7: Solves and explains one-step problems involving multiplication and division with whole numbers using informal strategies and/or formal recording. Solves and explains solutions to problems involving simple patterns, percent and proportion. May not be able to show working and/or explain strategies for situations involving larger numbers or less familiar problems. Constructs/locates fractions using efficient partitioning strategies. Beginning to make connections between problems and solution strategies and how to communicate this mathematically</p>
<p>Level 8: Uses appropriate representations, language and symbols to solve and justify a wide range of problems involving unfamiliar multiplicative situations, fractions and decimals. Can justify partitioning, and formally describe patterns in terms of general rules. Beginning to work more systematically with complex, open-ended problems.</p>

Table 1. Summary Learning Assessment Framework for Multiplicative Thinking

## CONCLUDING REMARKS

The detailed item response analysis generally supported the developmental sequence reflected in the initial HLT, but the richer descriptions generated by the analysis prompted a reduction in the number of categories and revealed some interesting anomalies. For instance, while the item response data confirmed that partitive division is generally more accessible than quotitive division (Greer, 1992), and discrete quantities such as *24 pots*, were generally easier to work with than continuous ones such as *34 metres* (Hart, 1981), the relatively late emergence of efficient partitioning strategies to represent or locate common fractions and decimals (Levels 6 and 7 of the Framework) suggests that the link between division and fractions and the issue of discrete and continuous might be much more complex than

previously imagined. The primary purpose of this paper was to describe the derivation of a Learning Assessment Framework for Multiplicative Thinking that is being used to help scaffold student learning in this area. While it is too early to speculate on the outcomes that may or may not emerge as a consequence of the action research component of the current study (Phase 3), classroom observations and teacher feedback to date are promising, suggesting that the LAF is a powerful tool in helping teachers identify specific learning needs and plan appropriate teaching responses. Subsequent analyses will address whether the teaching responses were effective.

**Acknowledgements.** The authors acknowledge the contribution of Shelley Dole, Max Stephens and Peter Sullivan who assisted with the identification of tasks and/or provided valuable feedback on earlier drafts of the Framework.

## References

- Adams, R., & Khoo, S. (1993). *Quest: The interactive test analysis system*. (Computer software & Manual). Melbourne: Australian Council for Educational Research.
- Anghileri, J. (1999). Issues in teaching multiplication and division. In I. Thompson (Ed.), *Issues in teaching numeracy in primary schools* (pp. 184-194). Buckingham, UK: Open University Press.
- Ball, D. (2000). Bridging practices: Intertwining content and pedagogy in teaching and learning to teach. In J. Bana & A. Chapman (Eds.), *Mathematics education beyond 2000 Proceedings of the 23rd annual conference of the Mathematics Research Group of Australasia* (pp.3-10). Fremantle: MERGA
- Battista, M. (1999). The importance of spatial structuring in geometric reasoning. *Teaching Children Mathematics*, 6(3), 170-178.
- Baturo, A. (1997). The implication of multiplicative structure for students' understanding of decimal-number numeration. In F. Biddolf & K. Carr (Eds.), *People in mathematics. Proceedings of the 20th conference of the Mathematics Education Research Group of Australasia* (pp.88-95). Rotorua: MERGA
- Callingham, R., & Griffin, P. (2000). *Street party assessment task*. Melbourne: Assessment Research Centre, The University of Melbourne.
- Clark, F., & Kamii, C. (1996). Identification of multiplicative thinking in children in grades 1-5. *Journal for Research in Mathematics Education*, 27(1), 41-51.
- Clarke, D., Sullivan, P., Cheeseman, J., & Clarke, B. (2000). The Early Numeracy Research Project: Developing a framework for describing early numeracy learning. In J. Bana & A. Chapman (Eds.), *Mathematics education beyond 20. Proceedings of the 23rd annual conference of the Mathematics Research Group of Australasia* (pp.180-187). Fremantle: MERGA
- Clarke, D., (2001). Understanding, assessing and developing young children's mathematical thinking: Research as a powerful tool for professional growth. In J. Bobis, B. Perry & M. Mitchelmore (Eds.), *Numeracy and beyond. Proceedings of the 24th annual conference of the Mathematics Education Group of Australasia* (pp.9-26). Sydney: MERGA

- Gray, E., & Tall, D. (1994). Duality, ambiguity, and flexibility: A 'proceptual' view of simple arithmetic. *Journal for Research in Mathematics Education*, 25(2), 116-140.
- Greer, B. (1992). Multiplication and division as models of situations. In D.A. Grouws (Ed.), *Handbook of Research on Mathematics Teaching and Learning* (pp.276-295). New York: Macmillan.
- Harel, G., & Confrey, J. (1994). *The development of multiplicative reasoning in the learning of mathematics*. New York: SUNY Press
- Hart, K.M. (1981). *Children's understanding of mathematics: 11-16*. London: John Murray.
- Izard, J., Haines, C., Crouch, R., Houston, S., & Neill, N. (2003). Assessing the impact of the teaching of modelling: Some implications. In S. Lamon, W. Parker, & K. Houston (Eds.), *Mathematical Modelling: A Way of Life: ICTMA 11*, (pp. 165-177). Chichester: Horwood Publishing.
- Lamon, S. (1996). The development of unitising: Its role in children's partitioning strategies. *Journal for Research in Mathematics Education*, 27(2), 170-193.
- Masters, G.N. (1982). A Rasch model for partial credit scoring. *Psychometrika*, 47, 149-174.
- Misailidou, C. & Williams, J. (2003). Diagnostic assessment of children's proportional reasoning. *Journal of Mathematical Behaviour*, 22, 335-368.
- Mulligan, J., & Mitchelmore, M. (1997). Young children's intuitive models of multiplication and division. *Journal for Research in Mathematics Education*, 28(3), 309-331.
- Rasch, G. (1980). *Probabilistic models for some intelligence and attainment tests*. Chicago: University of Chicago Press (original work published 1960).
- Siemon, D., & Stephens, M. (2001). Assessing numeracy in the middle years – The shape of things to come. In S. Thornton & B. Lee (Eds.), *Mathematics: Shaping Australia Proceedings of the 18th Biennial Conference of the Association of Mathematics Teachers* (pp.188-200). Adelaide: AAMT (CD Rom).
- Siemon, D., & Virgona, J. (2001). *Roadmaps to numeracy – Reflections on the Middle Years Numeracy Research Project*. Paper presented at the AARE Conference, Fremantle, WA. <http://www.aare.edu.au> (search code SIE01654)
- Simon, M. (1995). Reconstructing mathematics pedagogy from a constructivist perspective. *Journal for Research in Mathematics Education*, 26(2), 114-145.
- Sullivan, P., Clarke, D., Cheeseman, C., & Mulligan, J. (2001). Moving beyond physical models in multiplicative reasoning. In M. van den Heuvel-Panhuizen (Ed.), *Proceedings of the 25th conference of the International Group for the Psychology of Mathematics Education (Vol.4, pp.233-241)*. Utrecht: PME.
- Watson, J., Kelly, B. & Izard, J. (2004). *Student change in understanding of statistical variation after instruction and after two years: An application of Rasch analysis*. Refereed paper presented at the AARE Conference, Melbourne, Vic <http://www.aare.edu.au> (search code WAT04867)



# SOURCES OF STUDENTS' FRUSTRATION IN BRIDGING MATHEMATICS COURSES

Anna Sierpiska

Concordia University

*This paper presents a study on students' frustration in "bridging" mathematics courses, which they have to take as prerequisites for admission into university programs of their choice. The paper focuses on two possible sources of frustration: (a) students' perceived irrelevance of mathematics for their future studies and professions and (b) their dependence on teachers for the validity of their solutions.*

## INTRODUCTION

Universities experience an influx of mature students who return to school to continue their studies or re-orient their professions. Candidates are often required to take pre-university level mathematics courses as a condition of their admission ("bridging courses"). These are courses in elementary algebra, functions, and one-variable calculus. Many students experience frustration in these courses (FitzSimons & Godden, 2000: 28). There is a need to know more about the sources of students' frustration.

Two years ago, I embarked on a study aimed at a better understanding of frustration in such prerequisite mathematics courses, using a questionnaire and interviews. In this paper, I will focus on an analysis of two possible sources of the frustration: students' perceived irrelevance of mathematics for their future studies or professions and students' dependence on teachers for the validity of their solutions.

The questionnaire for the study is available at <http://alcor.concordia.ca/~sierp/>.

## RELATIONS WITH RELEVANT LITERATURE

The study is situated in the intersection of two research areas: affect (e.g., Hannula et al., 2004) and adult mathematics education (e.g. Coben, 2000). The population I am most interested in are "mature" students (in my university, this means 21+ years old and having spent some time away from formal education).

In mathematics education research, "frustration" is often mentioned in the context of descriptions of affect in problem solving, but the concept is rarely an object of study in itself. An exception is the work of Handa (2003). In the psychological literature, frustration is defined in various ways, depending on the adopted theory of emotion. According to Mandler (1975: 164-4), frustration is a kind of negative emotion aroused upon encountering an obstacle to satisfying one's needs, goals or expectations, which interrupts the ongoing activity. Mandler refers to previous laboratory research on frustration in claiming that the more alternative strategies are available immediately following the interruption, the greater the chances for relaxation of stress.

---

2006. In Novotná, J., Moraová, H., Krátká, M. & Stehlíková, N. (Eds.). *Proceedings 30<sup>th</sup> Conference of the International Group for the Psychology of Mathematics Education*, Vol. 5, pp. 121-128. Prague: PME. 5 - 121

This is an important aspect for me: my hypothesis is that technical knowledge of a mathematical method without its theoretical justification, is not sufficient to provide those "alternative strategies" at the time of getting stuck on a problem. Frustration thus remains unresolved and may lead to abandoning the task. Yet, the bridging courses tend to focus on the teaching of rigid techniques: one technique for a given type of problem. Using the terminology of Chevallard's theory of teacher's practice (2002) and in particular, his distinction of "moments of study", these courses merge into one the moments of "first encounter" with a task, the "technical moment" and "institutionalization", and reduce the mathematical practice to its practical-technical bloc with little or no attention to the technological-theoretical bloc.

The perceived irrelevance of mathematics, and dependence on teachers for the validity of solutions, often linked with lack of interest for the validity, are well known "affective variables" in the literature. Perceived relevance of mathematics is known to be an important factor in career choice. For students' dependence on teachers in learning mathematics, researchers blame the traditional classroom culture, which appears to teach students not to be responsible for the mathematical validity of their solutions (e.g., Schoenfeld, 1989; Lampert, 1990; Stodolsky et al., 1991). Lack of interest in validity has been reported by several authors (e.g. Evans, 2000: 179).

## **THEORETICAL PERSPECTIVE**

*A model of emotion.* There was a time when it was common to reduce the learner's organism to only one system – the cognitive system – and to study its various states. But approaches that integrate cognitive, emotional and sometimes also socio-cultural processes are more frequent today. Comprehensive and dynamic models of the psychology of emotion are needed, which made Scherer's (2000) *process component model* of emotion attractive for mathematics educators (e.g. Op 't Eynde, 2004). In this model, the functioning of the cognitive system is seen as always interacting with other organismic systems: the arousal of the autonomic nervous system, the expression of the motor system, the action tendencies of the motivational system and the feeling of the monitor system. In periods of emotional calm, the interaction is low. In the process of emotion, the functioning of the systems becomes highly interdependent and interrelated.

*A model of adult learning.* For the study of affect in adult mathematics education, Evans and Wedege (2004) proposed to adapt Illeris' model of learning (2003): "1) All learning includes two basic processes: an external interaction process between the learner and his or her social, cultural and material environment, and an internal psychological process of acquisition and elaboration; 2. All learning includes three dimensions embedded in a societally situated context: the cognitive dimension of knowledge and skills, the emotional dimension of feelings and motivation and the social dimension of communication and co-operation."

*The perspective of didactics: taking into account the institutional context.* Scherer's theory of emotion is an abstract psychological theory that does not study relations between emotions and the situations in which they occur. Illeris' model reminds us

that in studying emotions in a learning situation from a *didactic* point of view – which is the point of view I wish to take in my study - the characteristics of the situation must be factored in. That is, the basic unit of study is meant to be not a just a psychological subject, but a didactic situation in which he or she participates. The situation is characterized by certain mathematical and didactic organizations and by the positions of the participants in relation to these organizations (Chevallard, 2002). A student's frustration, when externalized, changes the situation into a very difficult one: communication is interrupted, the learning process is broken, and neither the teacher nor the student can go on in the same way. Different pedagogical and didactic interventions, other learning strategies have to be tried.

The choice of the interventions and learning strategies is constrained by the *institution* in which the didactic situation takes place. In my study, I treat the mathematics bridging courses as an institution, with its own "action arena" (course outlines, classes, exams, instructors, students) and "exogeneous variables" (e.g. rules of passing the courses) (Ostrom, 2005: 15). They are an institution within an institution (defined, among others, by the university rules of admission into academic programs). Students often blame their frustration on how these two institutions are interconnected. They knock on the door of, say, a school of business, and it turns out that the doorkeeper is a mathematician. Some students consider this rule of the game to be unfair (as we know from interviews with students). How can a mathematician decide if they "belong" to the school of business or not? Also, the content of the courses, the way they are run and students are evaluated, depend a lot on the mathematics department's resources, needs and goals, as well as on the moral commitment of faculty to values that they consider both *natural* and important (Douglas, 1986). Knowing these resources, needs, goals and values may help to explain students' frustrations and assess the possibilities of reduction of the institutional sources of these frustrations.

## THE RESEARCH INSTRUMENT

A questionnaire was designed and sent to about 800 students enrolled in the bridging courses; 96 responses, 63 from mature students and 33 from non-mature students were obtained. Interviews with 6 students were also conducted.

The questionnaire items were inspired by existing instruments (e.g., Haladyna et al., 1983; Schoenfeld, 1989) and experience of teaching the bridging courses. The organizing principle for the choice of items was to cover the respondent's *appraisal*, *action tendencies* and *feelings* (Scherer, 2000), from the positions of *Person* or member of a society at large, *Learner* of mathematics, *Student* in the bridging courses and *Client* of the university institution. As *Person*, the respondent was addressed in items about gender, age, time spent away from education and also in the open item about math: "Complete the sentence, 'Math is...'. As *Learner*, the respondent was asked to agree, disagree, or remain neutral to statements about, e.g. the difficulty of mathematics, or learning habits (e.g. "I need the teacher to tell me if I am right or wrong"), and to express preferences with regard to certain mathematical statements,

thus revealing his or her action tendencies in front of certain mathematical tasks. As Student – the respondent is in the position of a *subject of the school institution*, who has certain obligations vis-à-vis of this institution: doing homework, taking tests. The item, "At university one is expected to be an autonomous learner", or "I did not work hard enough in the course" addressed the respondent as Student. Items such as, "I would rather not take the course if I had a choice", "I will never use most of the material we covered in the course", or "In the course, there was little feedback on my performance" addressed the Client of the university institution, who asks for services, pays for them and has the right to evaluate their quality. The questionnaire included open items (e.g. explain why you like or dislike math, why you think you have succeeded or failed a course, complete the sentence "Math is..."), which left the choice of the position to the respondent.

Responses were analyzed using simple descriptive statistics and the psychological and institutional perspectives outlined above.

## RESULTS

The following abbreviations will be used: "ms" for mature student(s), "nms" for non-mature student(s).

*Being forced to take a bridging math course and feeling unhappy about it.* The respondents were generally "enthusiastic about coming back to school" (84% of all 96 students agreed with this statement in item 9; 95% of 63 ms did so and even 64% of the 33 nms agreed, although this question was not for them, really, since they never left school). Respondents were not so enthusiastic about taking math courses, though.

"Math is extremely discouraging when you are forced to take it as a prerequisite. If I were going for a major in math, then I would understand that the course is necessary. However, in the commerce program, there is nowhere near as much or as difficult math as I have just taken. I also have another year of math prerequisites to take in order to get into the program I want. If I fail math, I don't get into commerce. So I feel math is the only thing that's stopping me from getting into the program I want.... I am currently spending 20 hours of studying math outside of class and I got 30% on my midterm. I'm starting to think that I'm the problem, and that's very discouraging." (Respondent # 39, ms)

About 2/3 of respondents (65% ms and 73% nms) reported taking the course because the academic advisor told them to (item 65) – we can consider these students to have been "forced" to take the course. Over 59% of all (54% ms, 70% nms) also agreed with "I'd rather not take this course if I had a choice" (item 13). Counting students who felt both forced to take the course and unhappy about it, we got 45% all, 40% ms and 55% nms. Mature students thus appeared to be more accepting of the situation than non-mature students. Not liking mathematics did not appear to be the main reason for students' reluctance: only 35% of the 57 students who would rather not take the course expressed their dislike of mathematics (in item 66 "I don't like math" or in completing the sentence, "Math is...", item 76) (38% ms, 30% nms). It was

slightly more likely to be a reason for ms than for nms. Therefore, sources of students' frustration with the bridging courses must be sought elsewhere than in their dislike of mathematics.

*Perceived uselessness of the mathematics courses.* Students expressed their doubts about the relevance of the math courses for them by agreeing with "I'll never use most of the material we covered in this course" (item 64), in their explanations of why they don't like mathematics (item 66) and in completing "Math is..." (item 76). We found that 44% of all students, 38% ms and 55% nms expressed this view at least once. Again, mature students appeared to appreciate mathematics more often than the non-mature students.

While uselessness was invoked in frustration, usefulness of math was not the main reason for being pleased with math. Of the 41 ms and 13 nms who said they liked mathematics, only 6 ms and 2 nms attributed it to some usefulness. One popular reason for liking mathematics was liking to solve problems and experiencing the "awesome feeling" – as one student put it – of finding "the correct answer" (17 students in all, 13 ms and 4 nms).

Unfortunately, it appears that students knew they got "the correct answer" not by checking or testing it themselves, but relying on teachers or books to tell them if they were right or wrong.

*Dependence on teachers for the validity of solutions.* Two thirds of the respondents agreed with "I need the teacher to tell me if I am right or wrong" (65% ms, 70% nms).

The questionnaire also contained items (74 and 75) where two kinds of solutions (labeled "a" and "b") to linear inequalities with absolute value were given and students were asked which one they liked better. Item 74 was about  $|2x - 1| < 5$  and item 75 about  $|2x - 1| > 5$ . Solutions "b" were based on the properties of inequalities with absolute value (e.g.  $|x| < t$  iff  $-t < x < t$ ). We will call them "theoretical". Solutions "a", which we will call "procedural", resembled the procedure, commonly used in high schools, where the solution of the inequality is reduced to the solution of two equations. The procedure contains many rules of deriving the solution of the inequality from the solutions of the equations, and students often have trouble remembering them and applying correctly. In item 74, both solutions were correct. In item 75, solution "a" ended with an incorrect result.

We chose these particular problems because, in my experience of teaching the bridging courses, some students displayed a remarkable resistance to adopting the theoretical approach, loudly protesting and arguing for the procedural one, which they "have always used", so "why would they have to forget what they have already learned". Thus, we hoped this question would provoke some stronger feelings in respondents and make them open up their hearts in responding to open items.

There was a very clear preference for the procedural solutions: 69% all, 65% ms and 76% nms chose solution a in item 74; 62% all, 52% ms and 79% nms chose the

incorrect solution  $a$  in item 75. Solution  $b$  in item 74 was chosen by 19% all, 21% ms and 15% nms; in item 75 solution  $b$  was chosen by 20% all, 24% ms and 12% nms. Very few students explained their preference of any type of solution by its being correct; "clearer", "simpler" were the common reasons. In item 75, only 3 ms and 1 nms explicitly remarked that solution  $a$  is incorrect. And even then, the assessment was not based on the fact that the set proposed as the solution did not satisfy the given inequality.

## DISCUSSION

Students' perception of the prerequisite mathematics courses as irrelevant for their future studies and professions, and their disregard for mathematical validity are understandable. The courses are focused on techniques: simplification of algebraic expressions, solving equations of various degrees and types, differentiation and integration, solving typical word problems. It may be hard for the students to understand the purpose of achieving mastery in solving problems such as: "Factor completely:  $6a^2 x^3 y + 10 a^3 x^4 y^4 + 14 a x^3 y^5$ ", given on a final examination in a course required as a prerequisite for admission into, among others, psychology. It may be impossible for them to assess the validity of their solution as well. In the course, there is no theory of irreducibility of polynomials, so "completely" cannot have the technical meaning of "irreducible". How can the students know when to stop factoring? What if the given expression were:  $2ax^3 y^5 + 6 a^2 x^3 y^3 + 2 a^2 x^4 y^3 + 6 a^3 x^4 y$  ? How would the students know that the factorization  $2 a x^3 y (y^4 + a(3 + x)y^2 + 3a^2 x)$  is not complete and try to reduce it further to  $2 a x^3 y (y^2 + ax) (y^2 + 3a)$  ? The correctness of the answer must be decided by the teacher's verdict and not a mathematical proof. To succeed in the course, students must learn the rules of an institutional game. They cannot figure these rules out otherwise than empirically, by looking at the teacher's reactions to their solutions. That's why they "need the teacher to tell them if they are right or wrong" so badly.

At the same time as agreeing with "I need the teacher to tell me if I am right or wrong", many respondents (70%) agreed that, at the university, one is expected to be an autonomous learner (item 38). I consider this discrepancy between, on the one hand, their vision of the ideal university student, as well as their probable sense of control over their lives as adults who just made an important decision (returning to study), and, on the other, their lack of personal agency as learners (Bandura, 1989) as a deep source of their frustration with the mathematics courses.

The word "deep" is used to reflect the fact students did not explicitly mention lack of control as a source of frustration. They didn't, because, maybe, this could feel like admitting to the loss of self-esteem, and maintenance of self-esteem is known to be very important for mature students (FitzSimons & Godden, 2000: 19-20). Students could maintain a positive self-esteem by relinquishing control (Sedek et al., 1998) and making the teachers responsible for their learning. If the teacher "cannot explain well" (a frequent complaint in the interviews), he or she is responsible for students' mistakes. This approach to the management of one's emotions could be interpreted as

a shift from the position of Learner (who is responsible for the results of one's cognitive activity) to the position of a Client, who is indignant when the expected services are not delivered. Failure is easier to accept if one doesn't see oneself as the problem, but can blame an institution. As argued above, to some extent, the institution is to blame, indeed.

## FURTHER CONSIDERATIONS

Institutions are difficult to change. They are based not only on conventions and rational rules of economy, but also on values that are considered "natural", and therefore impossible to change without destroying the world in which they live (Douglas, 1986: 46). Any attempt at changing or developing an institution in a certain desired direction must therefore be based on a thorough understanding of what constitutes its stable "genetic code" (Ostrom, 2005) and what are the things that can be changed without jeopardizing its existence.

In the case of the bridging mathematics courses at my university, the problem is to find if there is a possibility of making room for just enough theory to allow students to develop some minimal autonomy relative to the validity of their solutions. Without this autonomy, these courses are, indeed, irrelevant for their future studies, because knowledge learned this way is not open for further development; it is good only – at most – for passing a final examination.

## Acknowledgements

1. This study was financially supported by SSRHC grant # 410 2003 0799.
2. The questionnaire was designed, and interviews conducted in collaboration with Christine Knipping and Georgeana Bobos.

## References

- Bandura, A. (1989). Human agency in social cognitive theory. *American Psychologist* 44(9), 1175-1184.
- Chevallard, Y. (2002). Organiser l'étude. 1. Structures et fonctions. In J.-L. Dorier et al. (Eds.), *Actes de la 11e Ecole d'Eté de Didactique des Mathématiques* (pp. 3-18). Grenoble: La Pensée Sauvage éditions.
- Coben, D. (Ed.). (2000). *Perspectives on Adults Learning Mathematics*. Dordrecht: Kluwer Academic Publishers.
- Douglas, M. (1986). *How Institutions Think*. Syracuse, New York: Syracuse University Press.
- Evans, J. & Wedege, T. (2004). People's motivation and resistance to mathematics in a lifelong experience. Paper presented at the Topic Study Group 6, at *ICME 10, Copenhagen, Denmark*, <http://www.icme-10.dk>.
- Evans, J. (2000). *Adults' Mathematical Thinking and Emotions, A Study of Numerate Practices*. London and New York: Routledge/Falmer.
- FitzSimons, G.E. & Godden, G.L. (2000). Review of research on adults mathematics learning. In D. Coben, J. O'Donoghue & G.E. FitzSimons (Eds.), *Perspectives on Adults Learning Mathematics* (pp. 13-46). Dordrecht: Kluwer Academic Publishers.

- Haladyna, T., Shaughnessy, J. and Shaughnessy, J.M. (1983). A causal analysis of attitude towards mathematics. *Journal for Research in Mathematics Education*, 14(1), 19-29.
- Handa, Y. (2003). A phenomenological exploration of mathematical engagement: approaching an old metaphor anew. *For the Learning of Mathematics*, 23(1), 22-29.
- Hannula, M.S., Evans, J., Philippou, G. & Zan, R. (coordinators) (2004). PME Research Forum RF01: affect in Mathematics Education – Exploring Theoretical Frameworks. In M. Johnsen Høines & A. B. Fugelstad (Eds.), *Proc. 28<sup>th</sup> Conf. of the Int. Group for the Psychology of Mathematics Education* (Vol. 1, pp. 107-138). Bergen, Norway: PME.
- Illeris, K. (2003). Towards a contemporary and comprehensive theory of learning. *International Journal of Lifelong Education*, 22(4), 396-406.
- Lampert, M. (1990). When the problem is not the question and the solution is not the answer: Mathematical knowing and teaching. *American Educational Research Journal*, 27(1), 29-63.
- Mandler, G. (1975). *Mind and Emotion*. New York: Wiley.
- Op 't Eynde, P. (2004). A socio-constructivist perspective on the study of affect in mathematics education. In M. Johnsen Høines & A. B. Fugelstad (Eds.), *Proc. 28<sup>th</sup> Conf. of the Int. Group for the Psychology of Mathematics Education* (Vol. 1, pp. 118-122). Bergen, Norway: PME.
- Ostrom, E. (2005). *Understanding Institutional Diversity*. Princeton: Princeton University Press.
- Scherer, K.R. (2000). Emotions as episodes of subsystem synchronization driven by non-linear appraisal processes. In M. D. Lewis, & I. Granic (Eds.), *Emotion, development and self-organization. Dynamic systems approaches to emotional development* (pp. 70-99). Cambridge, UK: Cambridge University Press.
- Schoenfeld, A.H. (1989). Explorations of students' mathematical beliefs and behavior. *Journal for Research in Mathematics Education*, 20(4), 338-335.
- Sedek, G. & McIntosh, D.N. (1998). Intellectual helplessness at school: Domain specificity, teaching styles and school achievement. In M. Kofta, G. Weary & G. Sedek (Eds.), *Personal Control in Action. Cognitive and motivational mechanisms* (pp. 419-444). New York and London: Plenum Press.
- Stodolsky, S.S., Salk, S., Glaessner, B. (1991). Student views about learning math and social studies. *American Educational Research Journal*, 28(1), 89-116.



# WHAT MAKES A GOOD PROBLEM? AN AESTHETIC LENS

Nathalie Sinclair and Sandra Crespo

Michigan State University

*Much work in mathematics entails aesthetics judgments and values that are not often reflected in school mathematics. For quite some time mathematics educators and researchers have suggested that aesthetic dimension of mathematics learning should receive greater emphasis. In order for students to appreciate the nature and value of the mathematical aesthetic, teachers must be able to incorporate these aspects into the sociomathematical norms of the classroom, and must thus in particular be able to recognize what makes a good or interesting problem. In this paper, we describe elementary pre-service teachers' responses to what makes a good problem, and show how quickly and generatively they were able to incorporate aesthetic dimensions into their judgments of problems worth using in the classroom.*

## INTRODUCTION

Twenty years ago, Dreyfus and Eisenberg initiated a discussion about the aesthetics of mathematical thought in their PME 9 working group on mathematical thinking, which they then reported in their 1986 paper. The paper was seminal in its way, first drawing on the testimonies of mathematicians to show that aesthetic aspects of mathematics are important in mathematical thinking and creativity and second, arguing that aesthetics should be an integral component of students' mathematical learning. In 2002, the editor of *Educational Studies in Mathematics*, Anna Sierpiska, reflected on research in mathematics education and argued that the aesthetic dimensions of mathematics learning deserves greater attention, naming it as one of the three areas of research underrepresented in journals and conferences. Indeed, little work had been done in pursuing the ideas put forth Dreyfus and Eisenberg.

For the past few years, co-author Sinclair has worked on elaborating the notion of the mathematical aesthetic introduced by Dreyfus and Eisenberg, seeking to understand the connections there may be between the lofty ideas summoned by the aesthetic claims of research mathematicians such as Hardy (1940), Hadamard (1945), and Poincaré (1908/1956)—just to name a few—and the prosaic realities of the mathematics classroom. At PME 27, Sinclair (2003) presented a paper claiming that it is both possible and desirable to incorporate aesthetic concerns into the mathematical activity of students, based on a re-articulation of both the nature and the purposes of the aesthetic in school mathematics that extended beyond the objective, product-oriented interpretations of the aesthetic implied by Dreyfus and Eisenberg. Sinclair critiqued them by showing that (1) both in research and school mathematics, aesthetic responses are often subjective and contextual (so that students can be seen as responding aesthetically to mathematical artifacts, even if their responses do not always agree with the responses of a particular research mathematician) and (2) aesthetic responses do not only arise in the context of judging the finished products of

---

2006. In Novotná, J., Moraová, H., Krátká, M. & Stehlíková, N. (Eds.). *Proceedings 30<sup>th</sup> Conference of the International Group for the Psychology of Mathematics Education*, Vol. 5, pp. 129-136. Prague: PME. 5 - 129

mathematics (the *evaluative* role of the aesthetic), such as theorems, proofs, definitions and even problems, but also arise in the course of mathematical inquiry, guiding the decisions made during problem solving (the *generative* role of the aesthetic), and in the process of selecting and posing problems (the *motivational* role of the aesthetic) (see Sinclair, 2003). The PME paper focused on the evaluative role played by the mathematical aesthetic and showed that students can and do behave aesthetically in the mathematics classroom, and that their aesthetic responses have very functional, yet pedagogically desirable, purposes: to establish personal and social value. However, and not surprisingly, the sociomathematical norms developed in the classroom were crucial in evoking the students' aesthetic responses.

The teacher is central in the development of sociomathematical norms that invite and value aesthetic responses. However, little is known about the degree to which elementary school teachers can recognize and respond to mathematical aesthetic qualities. Given their relative lack of experience and comfort with mathematics, it would seem reasonable to assume that pre-service elementary teachers would have a difficult time in developing the sociomathematical norms in the classroom that would emphasise the importance of aesthetics. In this study, we seek to ascertain the extent to which pre-service elementary teachers can draw on and even develop aesthetic responses in a problem-posing context. This investigation entailed assessing the kinds of problems that prospective teachers posed under different conditions, the extent to which these problems could qualify as being “good” mathematical problems, and the very issue of what makes a mathematics problem “good.”

## **AESTHETIC CONSIDERATIONS IN PROBLEM POSING**

In the world of research mathematics, aesthetics are involved in determining whether or not a given problem is “good” or “interesting” (Sinclair, 2002). And in reflecting on the status of posed problems, it becomes evident that aesthetics are also difficult to avoid in school mathematics: solutions to problems can be evaluated—if nothing else—by the criterion of correctness, but posed problems are neither right nor wrong. Thus, in order to evaluate posed problems, other forms of criteria must be brought to bear. This helps to explain the preponderance of subjective and aesthetic vocabulary found in the mathematics education literature on problem posing; researchers frequently use words such as “interesting,” “good,” “rich,” “worthwhile,” and so on, when describing the quality of the problems students have posed.

In the mathematics community, posed problems are frequently evaluated on aesthetic grounds (Sinclair, 2004). While there are some mathematical problems that are more famous and even more fashionable than others, it would be difficult to argue that there is an objective perspective—a mathematical reality against which the value of mathematical products can be measured. Contrast this with physics where questions and products can be measured up against a physical reality, for instance, how well they seem to explain the shape of the universe or the behavior of light.

Turning away from the context of the research mathematician now, we are faced with the following question: what makes a “good” problem in school mathematics

contexts? For the teacher, a good problem, one she intends to use in her classroom, might satisfy various pedagogical goals that, at first blush, have little to do with aesthetic motivations. Even then, however, it is difficult to remove questions of taste and aesthetics from consideration. For example, teachers may be drawn to problems that are clearly stated, or that evoke surprise. A good problem might be one that also opens up the opportunity to pursue new mathematical ideas in the classroom; this is related to the notion of fruitfulness cited by mathematicians. Finally, a good problem might help illustrate a mathematical relationship in a particularly powerful way, just as the right example can often illustrate a generalization. This gives the problem both mathematical and pedagogical potential. What makes a problem good will certainly depend on its intended use: a student posing a problem that he or she intends to solve will—and should—use different criteria from those a teacher designing a problem that he or she intends to use to introduce a new topic in the classroom draws on.

As we have already noted, although the discourse around the problems students (teachers included) pose in mathematics classrooms often allude to aesthetic criteria (good, rich, interesting) these have been elusive and difficult to define. In addition, research that has found that teachers do not, in general, pose mathematically interesting problems (e.g., Crespo, 2003; Nicol, 1999; Silver, Downs, & Leung, 1996). They tend to pose problems that are merely factual or too open-ended. Such problems often also lack aesthetic appeal. By drawing explicit attention to the aesthetic aspects of problem posing, we wanted to investigate the effect that providing the pre-service teachers with a richer sense of what makes a “good” mathematics problem would have on the quality of their posed problems.

## **THE STUDY**

We conducted our research in the context of a mathematics methods course taught by Crespo, and observed by Sinclair. This course is offered in the fourth year of a five-year teacher preparation program. At this point in their program, teacher education students have completed three years of liberal arts credits, pre-requisite courses in education and content courses related to teaching science, mathematics and literacy in elementary schools. The study participants were twenty-one pre-service teachers in a mathematics education course section. They were typical of the teacher education candidates in this program, in that all were Caucasian and only two were male.

In this paper, we focus on the third portion of a semester-long effort to develop the problem-posing abilities of the pre-service teachers. We used a wide variety of rich mathematical situations designed to evoke a significant number of mathematical ideas and relationships could be identified. We also experimented with several different ways of presenting these situations; they were asked to generate lists of problems after a certain amount of time spent exploring them; they were asked to identify problems based on observations of a classmate’s explorations; and, they were asked to create and compare problems that were both “open” and “closed” (using Vac’s (1993) classification). Several of the situations we used were adapted from previous research on problem posing (including Vac’s “tangrams” and Silver and

Cai's (1996) "driving home"). Based on research indicating that dynamic geometry environments may provide richer situations for problem posing (see Sinclair, 2002), we also proposed several situations designed for elementary school mathematics across the curriculum (see Sinclair and Crespo, in press).

### **Intervention: What Makes an Interesting Problem?**

Prior to the example reported here, the overall evaluative tendency, particular in our classroom discussions of the posed problems, was for the pre-service teachers to appeal to what we came to refer to as the *nutritional* value of a problem. A posed problem was deemed better if it was "good" for its intended audience (elementary school students). The pre-service teachers had two conceptions of "good." First, "good" problems allowed students to exercise a certain degree of creativity or independence: they allowed students to explore on their own, gave rise to many different solutions, or were open-ended. Second, "good" problems related to specific content objectives; they allowed students to use specific skills, or uses vocabulary they had been taught, or see properties that had been learned.

Despite the good intentions behind the pre-service teachers' problem-posing efforts, we found that the problems they posed lacked mathematical richness; we did not find that their problems would enable students to develop deep mathematical understandings. Furthermore, they very rarely evaluated their posed problems in terms of mathematical criteria, or in terms of any aesthetic criteria. We thus asked the pre-service teachers to pose problems within a new dynamic geometry situation and to design problems that were *mathematically* good, rather than good for students. In order to explain this distinction, which some of the pre-service teachers found confusing, with good reason, we introduced the metaphors of "nutritious" and "tasty." Most people agree that it is important to have nutritious food, that is, food that is "good" for one's health; however, one would not want to (and, in general, one does not) always eat things because of their nutritional value—most of us are also interested in eating things that are tasty. Similarly, in the mathematics classroom, there are problems that might be nutritious for students, such as the factual ones the teachers tended to prefer, but they are not necessarily tasty. Our pre-service teachers were very receptive to this distinction and adopted the new vocabulary immediately. We emphasized that problems could be both nutritious and tasty, that evaluating taste is a subjective enterprise, and that tasty problems are not necessarily more appropriate for use in a classroom, depending on the goals of the teacher.

### **Introducing a New Problem Posing Situation: The Bugs Sketch**

We chose to use the *Sketchpad* "Bugs Sketch" that we had previously developed, with which we had generated many problems ourselves in designing third grade tasks. We hoped that the unusual sketch would help the pre-service teachers focus less on familiar classroom problems and more on the situation's mathematical possibilities. When opened, the Bugs Sketch reveals a screen with a fixed number of green dots that represent bugs flying about all over the screen (see Figure 1(a)). The sketch allows the user to arrange the bugs into groups by pressing the REDLIGHT!

button. The number of bugs in each jar is determined by the ‘group by’ number, which the user can change. When the user specifies a number to ‘group by,’ the bugs arrange themselves in a circular formation consisting of groups determined by the ‘group by’ number. Figure 1(b) shows the circular formations created by a ‘group by’ value of four. Note that there are six full groups of four bugs and one ‘leftover’ group of two bugs.

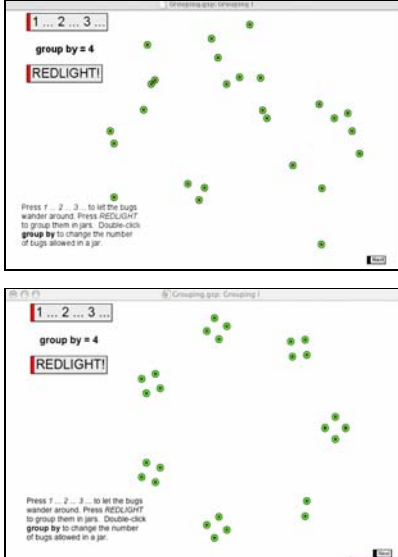

Figure 1: The Bugs Sketch

The pre-service teachers worked on this task during the ninth week of class at a time when the class was studying the topic of teaching number and operations. They worked in pairs to explore the *Sketchpad* microworld for approximately thirty minutes. One pre-service teacher in the pair acted as scribe while the other controlled the mouse and keyboard. The pairs were then asked to generate as many mathematics problems as they could, and then to nominate the two most mathematically interesting ones.

We begin by listing the full range of problems posed (there were twenty-four problems generated in total, and fifteen distinct ones). We then consider the aesthetic appeal of these problems, first from the perspective of

pre-service teachers, and second, from our own perspective, which is drawn from criteria Sinclair (2003) identifies among mathematicians (fruitfulness, visual appeal, surprise, apparent simplicity, novelty, extremes, generative constraints).

1. Without counting could you figure out how many bugs there are?
2. How can you group the bugs so that there is one left over?
3. How can you group the bugs so that there are none left over?
4. What happens when you increase/decrease the number that you group by?
5. What groupings work without leaving an odd group?
6. What number can you group by to make one full circle?
7. When entering numbers over twenty-six, what happens to the bugs when you choose numbers that are higher and higher?
8. Can you make a circle of bugs?
9. What is the largest number you could group by to make two groups total?
10. How are the groups made when decimal numbers are used?
11. In what order do the groups form? Is there a group that is always full?
12. What do you notice about the paths the bug travels in? Is there a pattern?
13. Do you notice a pattern?
14. What shape did you like most?
15. Make a number sentence that illustrates bugs in groups of 5.

After reading their problems to the whole class, the pre-service teachers were invited to explain what made them “mathematically interesting.” Most used the word “tasty” in their descriptions, without providing explicit details; however,

others also appealed to some of the specific criteria we had developed. For example, the pre-service teachers found the problems involving more than twenty-six bugs and non-integers (the 7<sup>th</sup> and 10<sup>th</sup>) tasty because they produced surprising results. Problem 1 was deemed “tasty” because of the added constraint “without counting.” Problems 6 and 8 were described as being “tasty” because of the fact that it has one obvious solution and one not so obvious solution, thus giving it some apparent simplicity. Both problems 11 and 12 were deemed “tasty” because the posers had not yet figured out how to solve them. By referring to the quality “tasty” and by citing some of the criteria discussed in class, the pre-service teachers were attempting to shift from the kinds of criteria they had previously used before in evaluating their posed problems. Not one student mentioned that a given problem would allow students to explore, or provide them with open-ended opportunities.

We now apply the aesthetic criteria offered earlier to this set of problems. According to these criteria, problems 13, 14, and 15 have the least aesthetic appeal. Not only do they not possess any of the criteria we have proposed, they do not pose *problematic* questions. That is, they are open-ended without providing an immediate opportunity for mathematical engagement. We propose that the remaining twelve problems all possess one or more of the aesthetic criteria we identified. The pre-service teachers have already described Problems 7, 8, 10, 11 and 12 using these criteria. In addition to their characterizations, we note that problem 12 possesses some visual appeal; in fact, it was in observing the pattern of the bugs forming into groups that the two pre-service teachers were led to devise this problem. The 9<sup>th</sup> problem involves a maximization challenge (thus connecting it to our group of pathological problems), and provided a constraint that could be interpreted in several ways. We found the 4<sup>th</sup> problem particularly compelling, as it leads to some novel, and non-obvious patterns: increasing the number to ‘group by’ sometimes increases the number of groups, and sometimes not. Furthermore, it sometimes increases the number in the leftover group, and sometimes not, thus providing some surprising patterns.

Problems 2 and 3 are similar. Neither is overly simple in that they both involve finding numbers that divide evenly into 26 and 25, respectively. Note that this way of formulating the problem actually simplifies it, while the way it was formulated by the pre-service teachers preserves the context of the bugs, and requires additional interpretation. We find both these questions challenging to classify in terms of aesthetic appeal. Certainly, when creating groups with no leftovers, there may be some visual appeal involved, since all the groups are equally composed. Groups with 1 leftover possess a degree of asymmetry that might be visually appealing to some. Problem 5 resembles both Problems 2 and 3 but is more generative than these two problems. The general statement about “an odd group” leads quite naturally to questions about an even group, or even to more specific questions about groups of 0 or 1. We note, furthermore, that it is frequently the case that interesting phenomena occur in mathematics around “special” numbers such as 0 or 1 and “special” classes of numbers such as even and odd.

Problems 11 and 12 strike us as “tasty” in terms of attracting the mathematical interest of the pre-service teachers who posed them, but their mathematical relevance is less well-suited to elementary school mathematics. The way the groups form and the paths the bugs travel in have more to do with the design of the sketch than with any mathematical relationships accessible to young students. However, both these problems emerged as genuine for the explorers, and prompted tenacious investigation.

## **SUMMARY**

Even with the multitude of resources now available, teachers still need to be able to decide on the quality of the problems they choose to use in their classrooms. Similar to the way that Ball, Bass and Hill (2004) have argued that aesthetic considerations are important to teachers’ choice of examples, we propose that aesthetic considerations are important in the choice of problems. Devising new problems to be used in the classroom involves a particular kind of problem posing on the part of the teacher. While this type of problem posing must be sensitive to pedagogical constraints than the problem posing of students or mathematicians, we argue they are similarities in terms of aesthetic considerations. We have shown that moving pre-service teacher beyond “factual” and “open” problems, which those in our study (and as reported in other studies as well) tended to privilege, can be achieved by drawing their attention to problems that have “tasty” features and providing them with opportunities to explore the aesthetics dimensions of problem posing.

In addition to devising good problems for students, teachers must also help negotiate socio-mathematical norms in the classroom, and these norms include aesthetic values (Yackel and Cobb, 1996). These sociomathematical norms include normative understandings of “what counts as mathematically different, mathematically sophisticated, mathematically efficient, and mathematically elegant in a classroom” (p. 461). While Yackel and Cobb focus on classroom interactions involving explanation, justification, and argumentation, we suggest that similar types of sociomathematical norms will also be involved in classroom tasks that promote problem posing and problem solving. Therefore, it seems important that teachers be prepared to recognize, reflect upon, and exemplify aesthetic aspects of mathematics in the classroom. We believe that the lack of research noted by Sierpiska in the introduction, and the lack of attention to the aesthetic aspects of student mathematical thinking identified by Dreyfus and Eisenberg, may well be due to teachers’ own lack of awareness of the roles of the aesthetic in teaching and learning mathematics. Dreyfus and Eisenberg found that undergraduate students had poorly developed sense of the mathematics aesthetic, but if teachers can foster an aesthetically-sensitive mathematics enculturation, then perhaps they can achieve “one of the major goals of mathematics teaching,” according to Dreyfus and Eisenberg, which is to “lead students to appreciate the powers and beauty of mathematical thought” (p. 2).

## References

- Ball, D., Bass, H., & Hill, H. (2004). *Knowing and using mathematical knowledge in teaching: Learning what matters*. Invited plenary address to the Southern African Association of Mathematics, Science, and Technology Education, Cape Town, South Africa, January 14, 2004.
- Crespo, S. (2003). Learning to pose mathematical problems: Exploring changes in preservice teachers' practices, *Educational Studies in Mathematics* 52(3), 243–270.
- Dreyfus, T. and Eisenberg, T. (1986). On the aesthetics of mathematical thought. *For the learning of mathematics*, 6(1), 2-10.
- Hadamard, J. (1945). *The mathematician's mind: The psychology of invention in the mathematical field*. Princeton, NJ: Princeton University Press.
- Nicol, C. (1999). Learning to teach mathematics: Questioning, listening, and responding. *Educational Studies in Mathematics*, 37(1), 45-66.
- Poincaré, H. (1908/1956). Mathematical creation. In J. Newman (Ed.), *The world of mathematics* (Vol. 4, pp. 2041-2050). New York: Simon and Schuster.
- Seirpinska, A. (2002). The rise of research in mathematics education. *Educational Studies in Mathematics* 50, 251-257.
- Silver, E. A. & Cai, J. (1996). An analysis of arithmetic problem posing by middle school students. *Journal for Research in Mathematics Education*, 27, 521-539.
- Silver, E. A., Mamona-Downs, J., Leung, S. S. (1996). Posing mathematical problems: An exploratory study. *Journal for Research in Mathematics Education*, 27, 293-309.
- Sinclair, N. (2003). The roles of the aesthetic in mathematical inquiry. *Mathematics Thinking and Learning*, 6(3), 261-284.
- Sinclair, N. (2003). Aesthetic values in mathematics: A value-oriented epistemology, *PME XVII*, Hawaii, U.S.A
- Sinclair, N. (2002). Initiating problem posing through exploration with Sketchpad. *PME-NA 2002*, Athens, Georgia.
- Sinclair, N. and Crespo, S. (2006). Learning mathematics in dynamic computer environments. *Teaching Children Mathematics* (in press).
- Vacc, N. (1993). Questioning in the mathematics classroom. *Arithmetic Teacher*, 41(2), 88-



# DISCOVERING A RULE AND ITS MATHEMATICAL JUSTIFICATION IN MODELING ACTIVITIES USING SPREADSHEET

Hong-chan Son and Hee-chan Lew

Korea National University of Education

*The present study has its objective in describing how students discover rules underlying a certain phenomenon at question and the process in which they mathematically justify such discovery by way of utilizing tables and graphs in use of the cell reference function of spreadsheet when a problem is not easily solved through simple symbol manipulation in a paper and pencil environment.*

## INTRODUCTION AND THEORETICAL FRAMEWORK

Mathematical modeling activities carry significance in that they offer students the experience of discovering and constructing their own mathematical knowledge, and in that they help students realize the applicability and necessity of mathematics. Generally modeling activities start from real-life situations, and therefore naturally accompany a great deal of complicated calculation and the discovery of patterns or rules implied within certain situations in order to understand and predict the problem situation. In such cases spreadsheet could be usefully used.

Not only is spreadsheet easy to use, but it can also provoke student-centered, discovery-centered learning (Beare, 1993; Beare & Hewitson, 1996; Baker & Sugden, 2003). In the course of utilizing spreadsheet, the interaction between fellow students, teacher and student, and computer and student becomes active (Hershkowitz, Dreyfus, Ben-Zvi, Friedlander, Hadas, Resnick & Tabach, 2002), and as students are enabled to design and manipulate more dynamic and visual spreadsheet models they are also able to explore diverse aspects of a phenomenon (Molyneux- Hodgson, Rojano, Sutherland & Ursini, 1999; Neuwirth & Arganbright, 2004).

Such distinctive features of spreadsheet serve as significant factors when students are carrying out modeling activities in small groups. When spreadsheet is used such mathematical models as tables and graphs that are necessary in carrying out modeling activities can be easily constructed, and they are also conducive in enhancing the user's intuition in developing and using algorithms and models necessary for solving mathematical problems (Masalski, 1990). In particular, the cell reference function of spreadsheet that when the value of referred cell is changed then the value in a cell in reference is changed and, consequently the related table and graph also are changed, makes students' exploration of a problem situation slightly more complicated and dynamic.

The present study attempts to look into how students discover rules inherent in problem situations and how they mathematically justify such discovery in modeling activities using spreadsheet.

## METHODOLOGY

Class experiments were conducted with 6 tenth grade students that were divided into two groups comprised of three students each. Only one of these students had prior experience in using spreadsheet. In terms of level of academic achievement, 2 were in the upper group of their class, 2 in the middle-upper, and 2 in the middle group of their classes. Each group was heterogeneously comprised according to which class the student came from and the students' level of academic achievement. The teacher was a male teacher with 9 years' teaching experience who had utilized spreadsheet for administrative purposes as recording grades. He had never used spreadsheet in his mathematics classes.

Each group that was comprised of three students was provided with one computer. The worksheets that were given in the experiment were divided into two parts: problem solving and reflection. The students were required to write down the problem solving process from partial to whole, and also particular difficulties they went through or feelings they had in using spreadsheet. The experimental class first attempted to solve the problems in a paper and pencil environment and then when the problems were not able to be solved students were asked to use spreadsheet so that they could solve the problem situation.

In exception of the 2 hours allocated for getting used to preliminary activities, the experimental classes were conducted 8 times, 2 hours each over approximately two months. The spreadsheet that was used for the experiment was Microsoft Excel 2003. Data analysis was carried out by comparing the recorded video capture files and the recorded audio files that were taken in each group. Analysis was conducted using a triangulation based on transcript, the video images, worksheets and survey data. The results that are presented here came from the 7th class using the problem situation suggested by Heid (1997, p. 96) (See Figure 1).

## STUDENT IMPLEMENTATION AND ANALYSIS

The two groups of students went through a similar process of problem solving and also obtained similar results. The activities of one group will be presented here.

### Discovery

Before using spreadsheet for problem 1, the students were able to establish such equations as  $(1040 \times 0.95) + 52 = x_1$ ,  $(x_1 \times 0.95) + 52 = x_2$ , where  $x_n$  is the amount of chlorine after  $n$  days, but were not able to move forward. When the teacher recommended to use spreadsheet the students made tables and graphs, and found out through observation that when the initial amount of chlorine put in is 1040g and 52g of chlorine is put in everyday, then the amount of chlorine continues to stay at 1040g and

There is a swimming pool that is 50 m in length, 21m in width and 1.8m in depth. There are bacteria spread out in the swimming pool and the manager is required to use chlorine so that the bacteria do not increase in further number. However if the leftover amount of chlorine is excessive it could cause a certain smell particular to chlorine and also stimulation to human skin. Therefore the amount of chlorine needs to be controlled to maintain 0.4~0.6ppm(mg/L). It should be noted that the chlorine put into the water is disappeared by 5% everyday.

1. If the swimming pool manager puts in 1040g at first and then puts in 52g of chlorine everyday, what concentration could the swimming pool maintain? If the initial amount of chlorine put in was changed to 850g, 1100g, 1300g respectively, then how would the concentration change according to the passing of time?
2. When the initial amount of chlorine is 1040g, and the amount of chlorine put in everyday is 40g, 60g, how would the amount and concentration of the chlorine change? In addition, discuss what kind of changes would occur when the initial amount of chlorine is changed and the reasons to such consequences.

Figure 1. Chlorine in the swimming pool problem

the concentration is approximately 0.550ppm. They also found that in the case where the initial amount of chlorine was adjusted to be less than 1040g, the amount continuously increased to come closer to 1040g, and in the case that the amount exceeded 1040g then the amount continuously decreased to come closer to 1040g.

The students were able to draw similar results in problem 2. Figure 2 displayed below indicates the changes in the amount and concentration of chlorine when the daily amount put in is 60g, and when the initial amount is respectively 1040g and 1300g. In Figure 2, the vertical axes of the graphs on the left indicate the concentration of the chlorine and those of the graphs on the right indicate the amount of chlorine. The horizontal axes of all graphs indicate the date. The upper two graphs in above and below of Figure 2 display the results of the first 30 days, and when the students were not able to accurately identify the flow of the changes in chlorine, they increased the number of days as in the two graphs set in the bottom in above and below of Figure 2, making the number of days 367, and drew graphs. The students were able to look for themselves the continuous increase or decrease of the amount and concentration of chlorine and then its maintenance with the passing of time, utilizing tables and graphs. Figure 2 is what Won-jin made in the course of carrying out the modeling activities and captured by the video capture software.

The following excerpt shows the process in which the students first explored the case when the daily amount of chlorine inserted was 60g, and they start to discover that there is a rule underlying between the amount of chlorine put in everyday and the remaining amount of chlorine in problem 2.

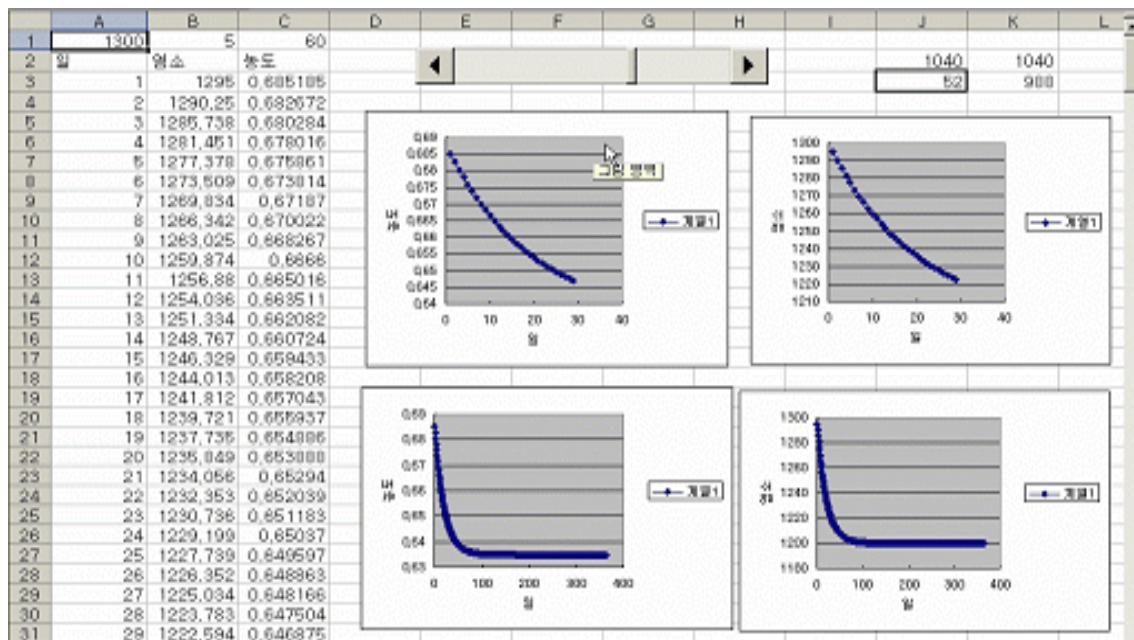
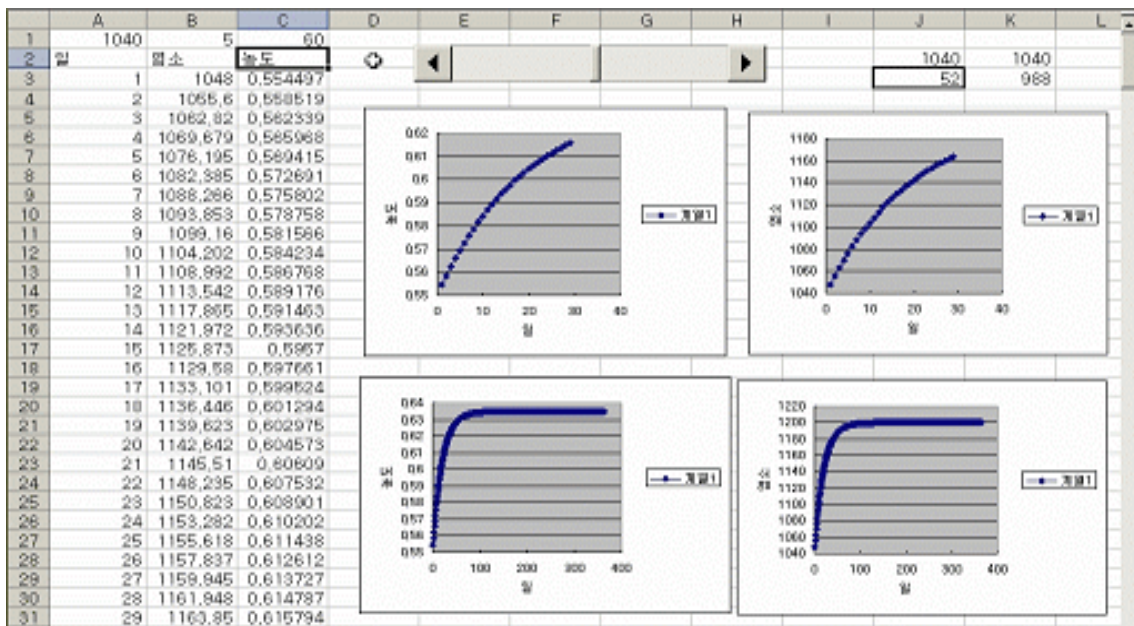

Figure 2: Changes in the concentration and amount of chlorine with initial amount 1040g (above) and 1300g (below)

1.1 Won-jin: The manager is putting in 60g everyday. That's what's important.

1.2 Ah-young: That's what's important. When it's 60... .

.....

1.3 Ah-young: According to how much chlorine is put in everyday, isn't it that the amount of chlorine is fixed? I mean, don't you think there's a pair?

1.4 Jung-yoon: Yeah, right. The pair of this....

1.5 Ah-young: The pair of this one is 52g.(indicating the initial amount of chlorine 1040g)

1.6 Jung-yoon: We can multiply it by 20. Multiply this by 20.(indicating that 60 multiplied by 20 is 1200)

- 1.7 Won-jin: That's right. With this. This.
- 1.8 Ah-young: Wow. Yeah. Wow.
- 1.9 Won-jin: We discovered a relation. We discovered something amazing. Wow wow wow.
- .....
- 1.10 Won-jin: It's right. Ha Ha. The amount multiplied by 20 is maintained.
- 1.11 Teacher: Why 20?
- 1.12 Won-jin: Because it's 0.5% of this. In other words, the 0.5 % of the amount, I mean, when the amount is 5% of the amount then it is maintained. (indicating the initial amount)
- 1.13. Jung-yoon: So 40 multiplied by 20 is 800.(The students had just explored the case when 40 replaced 60)

The students found out that as in (1.1), what determined the remaining amount of chlorine or concentration was the 60g of chlorine that was put in everyday. Furthermore, Ah-young was able to roughly assume the relationship between the fixed amount of chlorine and the amount put in everyday (1.3). Jung-yoon found out that when the daily amount put in was multiplied by 20 then a steady amount of chlorine would be produced (1.6). Won-jin realized that this was related to the 5% of chlorine that disappeared everyday (1.12). (1.8), (1.9) and (1.10) show the students rejoicing to such discovery.

In the course of solving these problems the students were able to understand that the remaining amount of chlorine and its concentration after a certain amount of time depend only on the daily amount of chlorine put in. They were also able to identify the relationships within the pairs of amounts comprising the initial amount and the daily amount, 1040g and 52g, 800g and 40g, and also 1200g and 60g. The reason the students were able to easily observe the relationship lied in the fact that they could dynamically change the graph using the cell reference function. In the same way the students were able to confirm that even in different cases when the daily amount of chlorine was neither 40g nor 60g, the amount of chlorine inched closer to 20 times the amount that was put in daily. It is worthy of note that the process of discovering a rule, the interaction among fellow students and computer was active and the teacher played a role of catalyst.

### Justification

In order to justify whether or not the chlorine remains at 20 times the amount put in daily, the teacher introduced the formula  $(x_n \times 0.95) + 40 = x_{n+1}$  to students. He wanted students to understand that they might set  $x_n = x_{n+1}$  for sufficiently large  $n$  and those values could be denoted by a single letter. This understanding is important for students who have not yet learned the convergence of sequences and limits to interpret their discovery mathematically. The following excerpt shows that the teacher's role of intervention over a role of catalyst.

- 2.1 Teacher: We want to find the value which becomes constant when  $n$  becomes sufficiently large. What do the values of  $x_n$  and  $x_{n+1}$  become when  $n$  is sufficiently large?
- 2.2 Jung-yoon: Become closer.
- 2.3 Won-jin: I don't know well. By the way there is no criterion for the largeness. And the difference between  $x_n$  and  $x_{n+1}$  is big when  $n$  is small.
- 2.4 Teacher: Well, what do you think about what we know? What do the values become when  $n$  is sufficiently large?.
- 2.5 Won-jin: Become close.
- 2.6 Teacher: You know that the values become almost the same. We want to get it.

Students accepted that  $x_n$  and  $x_{n+1}$  are same when  $n$  is sufficiently large while the values  $x_n$ 's were different when  $n$  was small. The observation of Figure 3 seems to be a help to the acceptance.

	A	B	C
1	1040	5	40
2	일	염소	농도
3	1	1028	0.543915
4	2	1016.6	0.537884
5	3	1005.77	0.532153
6	4	995.4815	0.52671
300	298	800.0001	0.42328
301	299	800.0001	0.42328
302	300	800	0.42328
303	301	800	0.42328
304	302	800	0.42328
305	303	800	0.42328

Figure 3: The amount and concentration of chlorine when the number of days is small (above) and large (below)

There were some difficulties in admitting that they might set all values  $x_n$ 's can be denoted by a single letter, but they came to such conclusion by the teacher's intervention. This means the students who have not learned the concept of limit formally could accept it intuitively by the informal approach through table and graph and teacher's proper intervention.

Figure 4 shows Jung-yoon's justification process when the amount of chlorine is respectively 40g and 60g. When the daily amount is 40g and  $n$  is large enough, Jung-

yoon utilized  $x_n = x_{n+1}$  and came up with  $x_n = x_{n+1} = (x_n \times 0.95) + 40$  and obtained the value  $x_n = 800$ .

Similarly Won-jin also put the amount of fixed chlorine as  $Y$  when  $n$  became large enough, and when 40g, put the equation as  $Y \times 0.95 + 40 = Y$  and found that  $Y = 800$ .

40g ...	60g.
$X_n = X_{n+1}$	$X_n = X_{n+1}$
$X_n = (X_n \times 0.95) + 40$	$X_n = (X_n \times 0.95) + 60$
$X_n = \frac{95}{100} X_n + 40$	$X_n = \frac{95}{100} X_n + 60$
$X_n - \frac{95}{100} X_n = 40$	$X_n - \frac{95}{100} X_n = 60$
$\frac{5}{100} X_n = 40 \times \frac{100}{5}$	$\frac{5}{100} X_n = 60 \times \frac{100}{5}$
$X_n = 800$	$X_n = 1200$

Figure 4: Jung-yoon’s mathematical justification

At first the students did not know the reason why their teacher introduced the formula  $(x_n \times 0.95) + 40 = x_{n+1}$  to justify that the remaining amount of chlorine is 20 times the amount put in daily, but later they understood the reason as the following answer given by Jung-yoon shows.

3.1 Teacher: Why do you multiply such 20?

3.2 Jung-yoon: When I simplify this. (pointing the formula  $(5/100) \times x_n = 40$  in Figure 4).

The other students also understood the reason and finally the fact that the multiplier depends on the rate of the disappearance of chlorine.

When asked to express her impression after using Excel in modeling activities, Ah-young said that she was able to find rules of problems requiring convoluted calculation using Excel, and in particular said that she was able to find out that the shape of the graph changed according to how much chlorine was daily put in. Won-jin explained that he could find out information relating to many different values by looking at the graph and added that math class would be more interesting if such software could be used in class. Considering the students’ reaction it is understood that Excel facilitates the exploration of rules inherent in problem situations and that students appreciated that Excel helps mathematics to be more fun and interesting.

## CONCLUSION

In learning through modeling activities, finding and justifying the patterns and rules embedded in daily life is necessary. The students presented here were able to determine that the amount and concentration of chlorine according to time did not depend on the initial amount put in but depended on the daily amount put in. They were also able to identify relationships between them and ultimately obtain mathematical justification.

Even in a pencil and paper environment, students were able to obtain basic recurrence formulas, but it was hard for them to understand the meanings implied in the algebraic models. In a spreadsheet environment they were able to freely deal such recurrence formulas and convert them into tables, and were also able to more accurately understand the meanings of them. The tables and graphs produced by the students could work as a mental tool to make them to form the mathematical concepts like limits of sequences intuitively. And students could use this tool to justify the rule they found mathematically.

In the discovering process the interaction among students with spreadsheet became more active than the teacher's role, but in the course of justifying process the teacher's role became more active than the interaction among students.

## References

- Baker, J. E. & Sugden, S. J. (2003). Spreadsheets in education-the first 25 Years, *eJSiE 1* (1), 18-43.
- Beare, R. (1993). How spreadsheets can aid a variety of mathematical learning activities from primary to tertiary level. *Technology in Mathematics Teaching: A Bridge Between Teaching and Learning*. B. Jaworski. Birmingham, U.K. 117-124.
- Beare, R. & Hewitson, J. (1996). Asking and answering all sorts of scientific questions using spreadsheets. *School Science Review 77* (281), 43-53.
- Heid, M. K. (1997). *Algebra in a Technological World*, Reston, VA: National Council of Teachers of Mathematics.
- Hershkowitz, R., Dreyfus, T., Ben-Zvi, D., Friedlander, A., Hadas, N., Resnick, T. & Tabach, M.(2002). Mathematics curriculum development for computerized environments: A designer-researcher-teacher-learner activity. In L. English (Ed.), *Handbook of International Research in Mathematics Education*, 657-694. Mahwah, NJ: Lawrence Erlbaum.
- Masalski, W. J. (1990). *How to use the spreadsheet as a tool in the secondary school mathematics classroom*, Reston, VA: National Council of Teachers of Mathematics.
- Molyneux-Hodgson, S., Rojano, T., Sutherland, R., & Ursini, S. (1999). Mathematical modeling: The interaction of culture and practice. *Educational Studies in Mathematics*, 39, 167-183.
- Neuwirth, E. & Arganbright, D. (2004). *The active modeler: Mathematical modeling with Microsoft Excel*. Belmont, California, Brooks Cole publishing company.



# INVESTIGATING PRESERVICE TEACHERS' UNDERSTANDING AND STRATEGIES ON A STUDENT'S ERRORS OF REFLECTIVE SYMMETRY

Ji-Won Son

Michigan State University

*This study examined how preservice teachers understand reflective symmetry and what types of pedagogical strategies preservice teachers use to help a student who has misunderstanding of reflective symmetry. It was found that a large portion of preservice teachers has limited understanding of reflective symmetry. It was also revealed that preservice teachers have tendency to rely on procedural aspects of reflective symmetry when helping a student understand reflective symmetry correctly although they recognized a student's misconceptions in terms of conceptual aspect. Furthermore, it was found that even a large portion of preservice teachers who showed sound understanding of reflective symmetry relied heavily on procedural aspects of reflective symmetry. This study has implication to researchers and teacher educators.*

## INTRODUCTION

It is well-known that the quality of teaching depends on teachers' knowledge of their subject. Since Shulman (1986) declared the missing paradigm in educational research as the study of teachers' knowledge, for two decades, researchers have devoted considerable attention to what teachers should know and be able to do. According to Shulman, it is not enough for mathematics teachers to know mathematics itself well and represent it understandably to students. Teachers should know students' common conceptions, misconceptions, and difficulties when learning particular content, and they should have the specific teaching strategies necessary to address students' learning needs in particular classroom circumstances.

Symmetry is an important concept in mathematics learning. *Principles and Standards for School Mathematics* (NCTM, 2001) sets symmetry as one of the significant geometry concepts. Symmetry is repeatedly stressed grade after grade in school curriculum. Besides, it has been applied to other mathematics strands as well as many other areas including physics.

However, there is not much research of how preservice teachers understand reflective symmetry and what kinds of pedagogical strategies they use in teaching reflective symmetry. Although recently, more research on teachers' pedagogical content knowledge has been widely published, there remains overlooked research on teachers' pedagogical content knowledge, in particular, pedagogical strategies. In addition, it has been reported that teachers commonly lack important strategies necessary to help students overcome those difficulties although teachers have some knowledge about students' difficulties, (Berg & Brouwer, 1991; Magnusson, Borko,

Krajcik, & Layman, 1994; Magnusson, 1991; Smith & Neale, 1989; Krajcik & Layman, 1989).

The purpose of this paper is to investigate preservice teachers' understanding of reflective symmetry and their pedagogical strategies when they help students who showed misunderstandings of reflective symmetry. This study is guided by two research questions:

- (a) How do preservice teachers understand reflective symmetry?
- (b) What types of pedagogical strategies do preservice teachers refer to in order to teach students reflective symmetry?

## **THEORETICAL FRAMEWORK**

In order to understand what and how teachers should know to teach reflective symmetry effectively, this study refers to the *Everyday Mathematics* curriculum, and the van Hiele theory.

### **Understanding of Reflective Symmetry**

The *Everyday Mathematics* curriculum (UCSMP, 1999), the most widely used standards-based reform curriculum in the U.S (Carroll, 1998), was analyzed from first grade to sixth grade. Symmetry in the *Everyday Mathematics* curriculum is introduced in the first grade, built upon throughout grade 2-5, and reintroduced in sixth grade.

In short, the *Everyday Mathematics* curriculum introduce symmetry by folding and matching (first and second grade), connecting the matching points and measuring the distance from each point to the fold line (third grade), using a transparent mirror to discover basic properties of reflections (fourth grade), and reviewing isometric transformations and performing them on geometric figures (sixth grade).

### **The van Hiele Theory**

This study was based on the van Hiele model of geometric understanding. There are five levels, which are sequential and hierarchical. The level and main characteristics are in Table 1. This is general criteria used, not specifically applied to symmetry. This study attempted to come up with levels specific for symmetry.

Level	Characteristic
Level 0: Visualization	Students visually recognize figures by their global appearance. They recognize triangle, squares, parallelograms, and so forth by their shapes, but they do not explicitly identify the properties of these figures.
Level1: Analysis	Students start analyzing the properties of figures but they do not inter-relate figures or properties of figures.
Level 2: Ordering	Students logically order the properties of figures by short chains of deductions and understand the interrelationships between figures.

Level 3: Deduction	Students start developing longer sequences of statements and begin to understand the significance of deduction, the role of axioms, theorems and proof.
Level 4:Rigor	The objects of thought at level 4 are deductive axiomatic systems for geometry.

Table 1. The van Hiele level (Clements and Battista, 1992)

## RESEARCH DESIGN

### Participants

Fifty-four preservice teachers participated in this study. Thirty-two were in their senior year of the elementary teacher preparation program and twenty-two were prospective teachers with a math major seeking middle and secondary school certification. Preservice teachers in secondary and elementary programs were included in order to obtain a broad range of responses to the study's task, since it has been reported that elementary teachers have limited knowledge of mathematics (Ma, 1999; Ball, 1990; Behr & Lesh, 1991; Simon, 1993). Thus, by including two different groups of prospective teachers with different backgrounds and experiences with mathematics, this study intended to collect richer information about pre-service teachers' reasoning and responses as well as gaining insights by contrasting the two groups' responses to the same task. However, there was no difference between two groups. Therefore, this study did not compare with and contrast to difference of understanding between two groups.

### Instrument

Two written tasks were developed, such as *Content knowledge task* and *Pedagogical strategies task*, based on Healy and Holyes' (1997) set of paper and pencil items, Rowan, et al. (2001)'s release items, and the *Everyday Mathematics Teacher's Lesson Guide* (UCSMP, 1999). Both two tasks focus on a common set of invariant properties: the reflected image is the same size and shape as the original, it is the same distance away from the line of symmetry, and is "opposite" or "reversed". When connecting corresponding points, it is the perpendicular line ( $90^\circ$  angle) to the line of symmetry.

For content knowledge, two multiple-choice questions and two construct items were developed. Multiple-choice questions contain one "correct" choice and three or four "incorrect" choices. First two multiple-choice items were developed based on the *Everyday Mathematics Teacher's Lesson Guide*. The *Everyday Mathematics Fourth Grade Teacher's Lesson Guide* provides common misconception students are likely to have when learning symmetry. It says, "Although the parallelogram has no lines of symmetry, many people think it does" (p. 742). In addition, the *Everyday Mathematics Teacher's Lesson Guide* from first through sixth grade says that the new figure of symmetry is the same size and shape as the original figure but the opposite of the original object; the distance from one point to the line of reflection is the same

as the distance from its matching point to the line of reflection. Based on these guides, the following questions were developed to assess preservice teachers' understanding. In the first question, preservice teachers were asked to identify the number of lines of symmetry in a parallelogram. In the second question, they were asked to choose the description that most closely matched the properties of reflective symmetry. The third and fourth questions were developed based on Healy and Holyes' set of paper and pencil items. In the third question, preservice teachers were asked to perform reflection. In the fourth question, they were asked to explain their strategies for the third question.

For pedagogical strategies, two construct questions were developed, based on Healy and Holyes' set of paper and pencil item. In Healy and Holyes' article, one student, called Emily, was asked to reflect the left flag to the slanted line. Her response is shown below. In the first question, preservice teachers were asked to identify Emily's errors. In the second question, they were asked to respond about ways to help Emily understand the reflective symmetry.

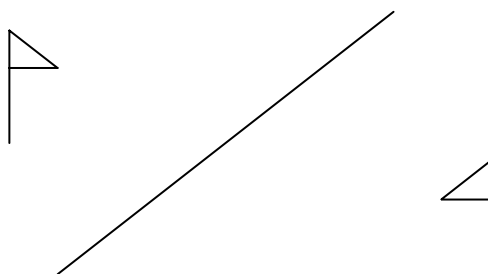

### Data Collection and Analysis

The task went through multiple layers of development which included pilot testing with two volunteers who were interviewed in order to check for possible misunderstandings. The task was then administered as a survey to the entire class in three mathematics methods course sections, two elementary and the other secondary, towards the end of the semester. We only report on the data of the prospective teachers who signed the study's consent form.

For data analysis, responses to the first and second question of content knowledge were graded based on a correct answer. For the remaining questions of content knowledge, two categories were developed based on *the Everyday Mathematics curriculum*: Knowing the properties of reflection (KR) and Creating the reflected image (CR). Each category was recategorized into three or more sub-categories depending on preservice teachers' responses to the questions. The first category (KR) is defined by how preservice teachers explained or identified given reflection problem in terms of the properties of reflective symmetry such as perpendicular line, equal distance, and diagonal line. The second category (CR) is defined by how preservice teachers answered by focusing on just creating the reflected image such as using mirror, flipping, turning the paper, folding and tracing, and coordinating. Three subcategories of KR and six subcategories of CR were identified: perpendicular line ( $90^\circ$  angle), equal distance, equal distance and  $90^\circ$  angle (KR); using mirror, flipping,

turning the paper, folding and tracing, coordinating, and matching (DR). Subcategories were coded as PL, ED, EDPL; M, FL, TP, FO, C and MA, respectively. For example, the response of KR to question 3 was coded as PL if students answered to the third question by focusing on perpendicular line or  $90^\circ$  angle, like “by drawing a perpendicular line from points on the figure to the line of reflection.” The response of CR to question 3 was coded as FO if students explained it like “I folded on the line and traced the flag on the back of the paper, then unfolded the paper and copied my trace from the back to the front of the page.”

For data analysis of pedagogical strategies, two more categories were added: Informal Expression (IE), and Misinterpretation (MI). IE is defined by how preservice teachers fail to identify Emily’s errors in terms of either properties of reflective symmetry or doing reflection. MI is defined by how the preservice teachers express lack of knowledge to Emily’s learning difficulties. For example, the response was coded IE if preservice teachers did not rely on or specify Emily’s errors either properties of reflective symmetry or creating the reflected image, like “she is confusing symmetry and mirror reflection.” The response was coded MI if preservice teachers answered, like “I don’t know” or “She is unable to visualize flipping the image over the line.” Table 2 shows categories and subcategories for data analysis.

Category	Subcategory
Knowing the properties of reflection (KR)	PL (Perpendicular line/ $90^\circ$ angle)
	ED (Equal distance)
	EDPL (Equal distance and angle)
Creating the reflected image (CR)	M (Mirror)
	FL (Flipping)
	TP (Turning the paper)
	FO (Folding and tracing)
	C (Coordinating)
	MA (Matching)
Informal Expression (IM)	
Misinterpretation (MI)	

Table 2. Category and Subcategory

## RESULT

### Research Question 1: How do preservice teachers understand reflective symmetry?

It was found that a large portion of preservice teachers has lack of content knowledge of reflective symmetry. A large portion of preservice teachers has misconception of reflective symmetry. They misunderstood that the parallelogram has lines of symmetry. They confused symmetry and rotation. When they were asked to explain

how to perform reflection, over half of preservice teachers relied on the procedural knowledge of reflective symmetry such as folding rather than focused on the properties of reflective symmetry.

In the first question, prospective teachers were asked to find how many lines of symmetry are in the parallelogram. Among prospective teachers, forty-one out of fifty-four prospective teachers (76%) answered correctly. Thirteen out of fifty-four prospective teachers (24%) answered incorrectly. Among prospective teachers who gave an incorrect answer, nine out of thirteen (69%) thought that the parallelogram have two lines of symmetry.

In the second question, prospective teachers were asked to choose a choice explaining the properties of reflective symmetry. Among prospective teachers, thirty-five out of fifty-four prospective teachers (64%) answered correctly. Nineteen out of fifty-four (36%) answered incorrectly. In particular, all prospective teachers who gave the incorrect answer chose answer, which says “When the original drawing is rotated, the two drawings match”, as the closest explanation to the line of symmetry instead of a correct answer c, which says “Every vertex is the same distance away from the mirror”. It is revealed that many prospective teachers confused the property of reflection and those of rotation.

In the third question, forty-six out of fifty-four prospective teachers (83%) represented reflective symmetry correctly. Eight out of fifty-four (17%) represented it incorrectly. Figure 1 show examples of incorrect representation of reflective symmetry.

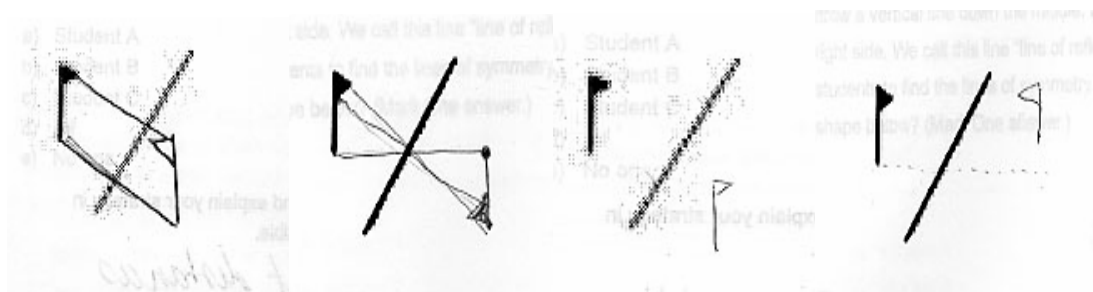

Figure 1. Examples of Incorrect Representations

In the fourth question, prospective teachers were asked to explain how they performed reflection in question 3. Twenty-three (43%) out of fifty-four prospective teachers explained reflection focusing on knowing the properties of reflective symmetry (KR). Twenty-nine (54%) explained it in terms of creating the reflected image (CR).

**Research Question 2:** What types of pedagogical strategies do preservice teachers refer to in order to teach students reflective symmetry?

It was revealed that regardless of teachers’ identification of student’s errors, a majority of preservice teachers relied on procedural aspect, such as the activities of doing the reflection, when they instructed students. In this study, preservice teachers were asked to identify one student’s errors and respond it, preservice teachers

identified student's errors from the conceptual aspect such as the knowing the properties of reflection (ex. equal distance) more than procedural aspect such as activities of doing reflection (ex. Folding, matching, etc). However, when they instructed students, they focused on procedural aspect more conceptual aspect.

In the fifth question, prospective teachers were asked to find out what Emily's errors are. Thirty-one out of fifty four (56%) prospective teachers identified Emily's errors in terms of knowing the properties of reflection. Ten out of the fifty-four (19%) focused on creating the reflected image. Table 3 shows the specific results.

Type of Identification	Subcategory	Response (N)	Total (%)
Knowing reflection	Diagonal line *	22*	56
	Equal distance	8	
	Distance and angle	1	
Creating reflection	Flipping *	5 *	19
	Matching	1	
	Coordinating	1	
	Inverting	1	
	Rotating	2	
Informal expression		3	6
Misinterpretation		10	19
Total		54	100

Note: \* represents the most frequently used subcategory

Table 3. Prospective Teachers' Identification of Emily's error

In the sixth question, prospective teachers were asked to respond to Emily's errors. Twenty-five out of fifty four (46%) prospective teachers instructed Emily referring to knowing the properties of reflective symmetry. Twenty-two out of fifty four (41%) instructed Emily in terms of creating the reflected image. Table 4 shows the specific results.

Type of Strategies	Subcategory	Response (N)	Total (%)
Knowing reflection	Diagonal line*	11*	46
	Equal distance	6	
	Distance and angle	8	
Creating reflection	Flipping	1	41
	Folding *	11*	
	Matching	1	

	Graph paper	2	
	Showing	1	
	Mirror	4	
	Rotating	2	
	Informal expression	1	2
	Misinterpretation	6	11
	Total	54	100

Table 4. Prospective Teachers' Pedagogical Strategies

To examine the consistency between prospective teachers' identification to Emily's error and their teaching, pedagogical strategies prospective teachers used were compared with prospective teachers' identification of Emily's errors. It was revealed that frequency of knowing the properties of reflection decreased in pedagogical strategies but frequency of creating the reflected image increased. This shows that even though prospective teachers identified Emily's errors as coming from knowing the properties of reflective symmetry incorrectly, they tried to cope with it by focusing on creating reflection such as folding, flipping, etc.

This study has implications for both teacher educators and researchers. First, this study showed that preservice teachers have limited understanding of reflective symmetry and have tendency to rely on the procedural aspects of reflective symmetry when using teaching strategies. Teacher educators need to put more emphasis on geometry and explore how to help preservice teachers improve their understanding and pedagogical strategies content knowledge of geometry. Second, one of the interesting results is that many preservice teachers confused reflection and rotation and used them in the same situation. When preservice teachers were asked to identify the characteristic of reflection, half of preservice teachers considered the explanation of rotation as that of reflection. However, there is little research why students or preservice teachers confuse reflection and rotation. Future study should specify what difficulties teachers have in teaching reflective symmetry as well as what confused students about the difference between reflection and rotation.

## References

- Bell, M., Bretzlauf, J., Dillard, A., Hartfield, R., Isaacs, A., McBride, J., Pitvorec, K., and Saecker, P. (2002). *Everyday Mathematics First to Sixth Grade Teacher's Lesson Guide Volume 1 and 2* (2<sup>nd</sup> ed.): The University of Chicago School Mathematics Project. Chicago: SRA/McGraw-Hill.
- Hoyles C. & Healy L. (1997). Unfolding Meanings for Reflective Symmetry, *International Journal of Computers in Mathematical Learning*, 2, 27-59.
- NCTM (2001). *Principles and standards for school mathematics*. Reston, VA: National Council of Teachers of Mathematics.



# EXPLORING THE ROLE PLAYED BY THE REMAINDER IN THE SOLUTION OF DIVISION PROBLEMS

Alina Galvão Spinillo & Sintria Labres Lautert

Federal University of Pernambuco, Brazil

*This study examines the possibility that children can overcome their difficulties with division when they learn how to deal with the remainder in division problems. One hundred children (8-11 years) were divided into an experimental and control groups, and were given a pre- and a post-test. Children in the EG were presented to a variety of problem solving situations in which the role played by the remainder in the process of division was emphasized. It was found that these children gave more correct responses and appropriate explanations than those in the CG after the intervention. The conclusion was that the understanding of the remainder plays an important part in the understanding of division. The nature of the intervention and its implications for mathematics education are discussed.*

## INTRODUCTION

Children's difficulties with division, especially with division-with-remainder (DWR) problems, are well known in the literature (e.g.; Correa, Nunes & Bryant, 1998; Lautert & Spinillo, 2004; Li, 2001; Nunes & Bryant, 1996; Spinillo & Lautert, 2002; Silver, Shapiro & Deutsch, 1993; Squire, 2002). Generally, children deal with the remainder in different ways: (i) they ignore the remainder or suggest that it be removed from the process of resolution, in the belief that the remaining elements are not part of the division; (ii) they try to distribute the remainder among some of the parts or include it in one of the parts in which the whole has been divided into; or (iii) they try to include the remainder in a new part. These ways of dealing with the remainder violates the invariant principles of the concept of division (Vergnaud, 1983). It seems that children do not consider the remainder as a component of the division which is related to the other components. In reality, children do not realise the meaning of the remainder in the solution processes when dealing with divisions. One may ask whether these difficulties would be overcome if children had concentrated experience with DWR problems. This idea was tested in an intervention study in which elementary school children who experienced difficulties with the concept of division were presented to a variety of problem solving situations involving discussions on the understanding of the role played by the remainder in division problems.

Based on the theory of conceptual fields, this investigation takes the invariants to be essential elements for the formation and understanding of mathematical concepts. As a second, but equally important theoretical support, the intervention provided to children in this study is based on the idea that metacognition plays a crucial role in the learning process.

## **METHOD**

### **Participants and Experimental Design**

The participants were 100 low-income children aged 8 to 11 years old attending the third grade of elementary schools in Recife, Brazil. All the participants experienced difficulties with division problems as tested in a previous task.

Participants were divided equally into two groups: Experimental Group (EG): children were individually given a pre- and a post-test and an intervention training procedure; and Control Group (CG): children were given a pre and a post-test only.

### **The Pre- and Post-test**

The tasks in the pre- and post- tests involved six DWR problems (three partitive and three quotitive problems). The examiner presented a card with a written version of the problem as well as a pictographic representation of the procedure to solve it, saying: 'I have given this problem to another child and h/she solved it correctly. H/she did it as it is shown in this card.' After having read the problem to the child the examiner asked two questions, as indicated below.

**Partitive problem:** Aunt Julia bought 23 books to give to her 5 nieces. She wants each niece to have the same number of books.

Interviewer: How many books each niece will get? What are these books on the side (remainder)?

**Quotitive problem:** Grandmother has 22 buttons. She is going to put 4 buttons in each bag.

Interviewer: How many bags will she need? What are these books on the side (remainder)?

### **The intervention**

During the intervention, the remainder was systematically highlighted becoming the focus of the thinking process of the child. There were occasions when the child was asked about the effect of increasing/decreasing the value of the remainder over the whole division process when the divisor or the dividend was kept constant (Activity 1). On other occasions the child was asked to think about the importance of the remainder when solving (correctly or incorrectly) DWR problems (Activity 2). The examiner provided the child with feedback and explanations.

In Activity 1, the examiner tried to make the child understand that by changing the value of the remainder we change the value of the dividend and that of the quotient, as exemplified below:

Partitive problem: Ana has bought 22 buttons and she wants to put them in 4 boxes. She wants each box to have the same number of buttons. How many buttons will she put in each box?

Variation 1: If we give three more buttons to Ana, how will she divide them into the boxes now? How will the division change?

Variation 2: And if we give another five buttons to Ana, how will she divide them into the boxes now? How will the division change?

Variation 3: And if we give another two buttons to Ana, how will she divide them into the boxes now? How will the division change?

Quotitive problem: Ricardo has bought 17 balloons. He wants to give 5 balloons to each one of his friends. How many of his friends will get the balloons?

Variation 1: And if we give 4 more balloons to Ricardo, will he have more friends to give the balloons to, or the number of friends stays the same? What changes in the solution to the problem?

Variation 2: And if now we give another 6 balloons to Ricardo, will he have more friends to give the balloons to, or the number of friends stays the same? What changes in the solution to the problem?

Variation 3: And if we give another 3 balloons to Ricardo, will he have more friends to give the balloons to, or the number of friends stays the same? What changes in the solution to the problem?

In Activity 2 the examiner tried to make the child think about the remainder and the relations it holds with the number of parts and the size of the parts when the dividend is not altered.

The child was presented with a card containing a written version of the problem to be solved. The examiner said: 'I have given this problem to another child and h/she solved it incorrectly. H/she did it as I am going to show you. I would like you to find out the mistake that h/she has made.' After several interventions, the examiner:

- (i) explained the mistake to the child (to ignore the remainder, the remainder being smaller than the other parts, remainder bigger than the number of parts, remainder bigger than the value of the other parts);
- (ii) explained to the child the general principle that the remainder cannot be equal or bigger than the number of parts or the size of the parts, and that the equality of the parts needs to be kept in the division, respecting the invariants which characterize this concept; and
- (iii) asked the child to solve DWR problems using concrete material. The examiner helped the child by providing explanations.

## RESULTS

### Correct responses

As it can be seen in Table 1, the intervention had a strong effect on children's performance.

	Groups	Types of problems		Total
		Partitive	Quotitive	
Pre-test	GC	1.66	1.64	1.65
	GE	1.94	1.70	1.82
Pos-test	GC	2.14	1.88	2.01
	GE	2.82	2.78	2.80

Table 1: Mean number of correct responses (out of 3).

The performance in the pre- and post-test in both groups was compared by means of an ANOVA. This showed that there the difference between the groups in the pre-test was not significant, neither in relation to partitive problems [ $F(1,98) = 1.524$ ;  $p = 0.220$ ] nor in relation to quotitive problems [ $F(1,98) = 0.090$ ;  $p = 0.765$ ]. This suggests that in the pre-test the two groups presented the same level of performance. However, the interaction Test vs. Group was significant [ $F(1,98) = 18.649$ ;  $p = 0.000$ ]. According to the Tukey Test this was due to the EG performing better than the CG in the post-test ( $p < .001$ ). Although both groups did better in the post-test in comparison to the pre-test ( $p < .001$ ) the improvement in the EG was more expressive than in the CG (Figure 1).

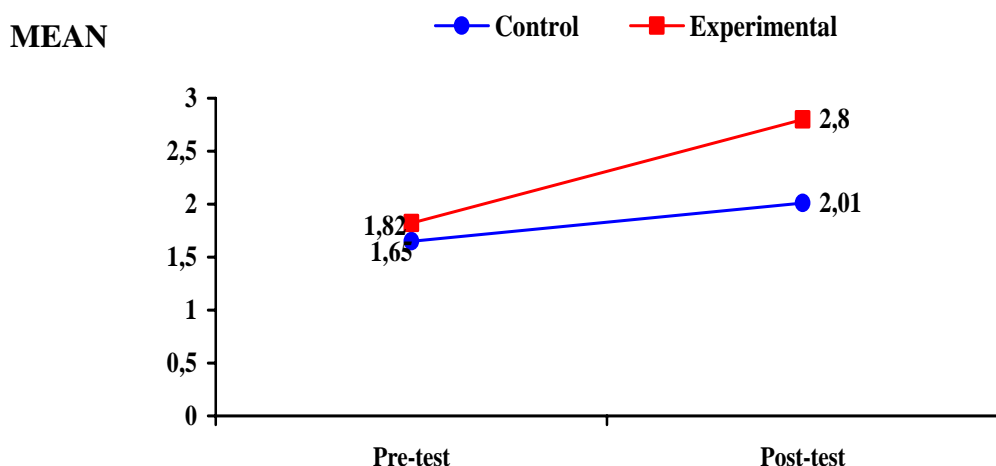

Figure 1: Interaction Test vs. Group

### Types of response

Four types of responses were identified. They are described and exemplified below:

Type 1: no response or imprecise responses.

Type 2: response violating the principle of equality between the parts.

João has 29 marbles and wants to put them in 4 boxes. He wants to put equal number of marbles in each box. How many marbles is he going to put in each box?

Children: Seven in each one.

Interviewer: In the problem solved, what is this marble here on the side?

Children: She forgot to put this one in a box.

Type 3: response associated with an everyday out of school situation.

Aunty Julia has bought 23 books to give to her 5 nieces. She wants each niece to have the same number of books. How many books each niece will get?

Children: Four each.

Interviewer In the problem solved what are these books on the side?

Children: These three books will be left outside. So she can give them to a friend of hers or to someone else, like a brother or a nephew, if she wants.

Type 4: response associated with the invariant principles of division.

Luciano has 22 motobike toys. He wants to put 4 motobikes in each box. How many boxes will he need?

Children: Five.

Interviewer: In the problem solved, what are these motobikes on the side?

Children: These cannot go into the boxes or the number of motobikes will be different.

Maria has bought 31 stars. She wants to put 5 stars in each box. How many boxes will she need?

Children: Six boxes.

Interviewer: In the problem solved, what is this star here on the side?

Children: This one is what was left. Because she wanted each box to have the same number of stars she cannot put this star in a box, otherwise they won't have the same number of stars.

Table 2 shows the distribution of the types of responses.

Responses	Pre-test		Pos-test	
	GC	GE	GC	GE
<b>Type 1</b>	1.10	0.95	0.91	0.11
<b>Type 2</b>	0.13	0.06	0.11	0.00
<b>Type 3</b>	0.27	0.52	0.30	0.05
<b>Type 4</b>	1.50	1.47	1.68	2.84

Table 2: Mean number of responses (out of 3)

An ANOVA was carried with each type of response, separately. The most important finding was that related to Type 4 responses: the interaction Test vs. Group was significant [ $F(1,98) = 38.642$ ;  $p = 0.000$ ]. The Tukey Test (Figure 2) showed that the interaction was due to significant differences between the groups in the post-test ( $p < .001$ ) and between the pre- and the post-tests in the EG ( $p < .001$ ).

#### MEAN

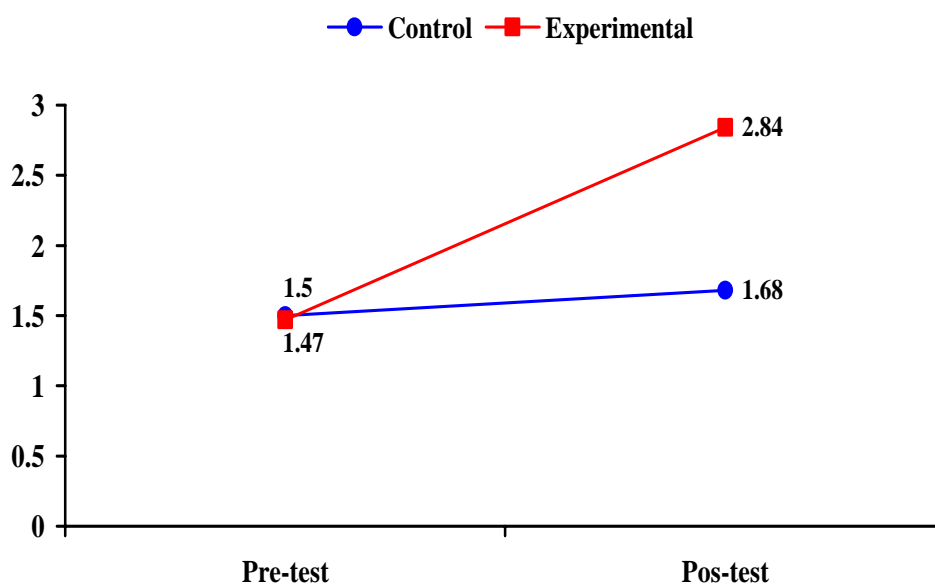

Figure 2: Interaction Test vs. Group (Type 4 responses)

It was found that the frequency of Type 4 responses given by the children in the EG was higher than those given by the children in the CG in the post-test. It has also been noticed that in the children in the EG have given more Type 4 responses in the post-test than in the pre-test.

## CONCLUSIONS AND DISCUSSION

The main conclusion derived from this study is that the intervention helped the children to reach a higher level of understanding about DWR problems. Although the performance of both groups improved in the post-test, the children in the EG showed a more expressive improvement than those in the CG. Whereas the children in the CG generally tended to continue to offer imprecise responses about the remainder, or to associate it with solutions which violated some of the invariant principles, the children in the EG were aware of the necessity to guarantee the equality between the parts and aware that the remainder cannot be larger than the number of parts or the size of the parts. The intervention helped children to overcome their difficulties by leading them to recognize the remainder as part of the division process. We believe that this is a step further in the understanding about the concept of division. One may say that the remainder, therefore, can be seen as a didactic tool capable of, when highlighted, helping children to develop more elaborated notions in relation to division. Thus, DWR problems should be introduced earlier in the elementary school curricula.

Finally, it is worth mentioning that it is important to associate metacognitive activities to teaching situations in which the invariants and the terms of a particular concept are emphasized as it was done in the intervention in this study.

## References

- Correa, J., Nunes, T., & Bryant, P. (1998). Young children's understanding of division: The relationship between division terms in a non-computational task. *Journal of Educational Psychology, 90* (2), 321-329.
- Lautert, S. L., & Spinillo, A. G. (2004). Inverse relations between division terms: A difficulty children are able to overcome. In M. J. Heines & A. B. Fugletad (Eds.), *Proc. 28<sup>th</sup> Conf. of the Int. Group for the Psychology of Mathematics Education* (Vol. 1, p.397). Bergen, Norway: PME.
- Li, Y. (2001). Does the acquisition of mathematical knowledge make students better problem solvers? An examination of third graders' solutions of division-with-remainder (DWR) problems. In M. van der Heuvel-Panhuizen (Ed.), *Proc. 25<sup>th</sup> Conf. of the Int. Group for the Psychology of Mathematics Education* (Vol 2, pp. 501-508). Columbus, USA: PME.
- Nunes, T., & Bryant, P. (1996). *Children doing mathematics*. Oxford: Blackwell.
- Silver, E. A (1988). Solving story problems involving division with remainders: The importance of semantic processing and referential mapping. In M. J. Behr, C. B. Lacampagne & M. M. Wheeler (Eds.), *Proc. 10<sup>th</sup> Conf. of the Int. Group for the Psychology of Mathematics Education*, (Vol. 1, pp.127-133). Illinois, USA: PME.
- Silver, E. A., Shapiro, L. J., & Deutsch, A. (1993). Sense making and the solution of division problems involving remainders: An examination of middle school students' solution processes and their interpretations of solutions. *Journal for Research in Mathematics Education, 24*, (2), 117- 135.

- Spinillo, A. G., & Lautert, S. L. (2002). Representations and solving procedures in word division problems: comparing formal and informal knowledge in children. In A. D. Cockburn & E. Nardi (Eds.) *Proc. 26<sup>th</sup> Conf. of the Int. Group for the Psychology of Mathematics Education*, (Vol. 1, p. 318). Norwich, United Kingdom: PME.
- Squire, S. (2002). Children's misunderstanding of an inverse relation. In A. D. Cockburn & E. Nardi (Eds.) *Proc. 26<sup>th</sup> Conf. of the Int. Group for the Psychology of Mathematics Education*, (Vol. 1, p 319). Norwich, United Kingdom: PME.
- Vergnaud, G. (1983). Multiplicative Structures. In R. Lesh & M. Landau (Eds.), *Acquisition of mathematics concepts and processes* (pp. 127-174). New York: Academic Press.



# INCOMPLETE OR INCORRECT UNDERSTANDING OF DECIMALS: AN IMPORTANT DEFICIT FOR STUDENT NURSES

Vicki Steinle & Robyn Pierce

University of Melbourne and University of Ballarat

*In this study more than 40% of the 355 student nurses who completed a pre-test, involving comparisons of decimal numbers, made errors that indicate an incomplete or incorrect conceptual understanding. This includes students who are sometimes able to achieve 100% on drug calculations tests. Seven test items with error rates of between 10% and 26% form the focus of our discussion. A sub-group of the students attended a one-hour remedial intervention using various physical materials to give conceptual meaning to decimal numbers. A matched post-test three months after the intervention, detected a statistically significant improvement for the intervention students but not for those who only practiced drug calculation procedures. Conceptual teaching for number sense is needed to underpin procedures.*

## INTRODUCTION

“Baby died after ‘decimal’ error.” This sensational BBC headline (BBC, 2005) serves to remind us of the everyday importance of competency in decimal calculations. In many occupations ‘getting it right’ most of the time is not good enough. As will be illustrated below, nurse educators are well aware of the responsibility that their students have to correctly interpret data and perform error-free calculations. In recognition of this, student nurses are commonly expected to achieve high scores, even 100%, on drug calculations tests (Sabin, 2001). However, a search of the literature strongly suggests both teaching and testing of drug calculations to nursing students assume conceptual understanding of decimals and consequently focus on calculation procedures.

In this paper we report the results of testing a cohort of Australian undergraduate nursing students for their conceptual understanding of decimal numbers, providing remedial teaching for some and then post-testing all of the available students. We contend that a significant percentage of these adult students have either incomplete or incorrect understandings about the decimal number system which will make it difficult for them to acquire procedural skills (such as drug calculations) with any understanding. They must then rely on memorizing a series of routines, which seem meaningless to them and which under the ‘wrong’ circumstances will result in error. Teaching interventions for these students need to address their fundamental understanding of decimals. In the next section of this paper we will consider the background literature both in terms of previous studies of nurses’ numeric skills as well as the diagnosis of misunderstandings of decimal notation in general. This will be followed by an outline of this study and intervention, an analysis of some of the key results and finally some recommendations.

## BACKGROUND

Studies of drug errors made by nurses have shown that one of the main sources of error is mathematical incompetence when determining the dose of a drug to be administered. Deficiencies have been identified in graduate and student nurses' basic computational ability with decimals, fractions, percentages, and ratios; see for example, Grandel-Niemi, Hulpi & Leino-Kilpi (2001), Hughes & Edgerton (2005), Sabin, (2001). This problem has been attributed to limited preparation of, or support for, nursing students who need to develop their numeracy skills (Sander & Cleary, 2004). Many studies focus on drug calculation skills and have identified common errors such as misplacing the decimal point (Hughes & Edgerton, 2005, Lesar, 2002). Lesar detected 200 cases of tenfold prescribing errors in hospitals over an 18-month period, with over-dosing cases (61%) outnumbering under-dosing cases. In reviewing the cause of tenfold medication errors, misplacement of the decimal point dominated other reasons (43%) followed by the practice of adding an extra zero (for example 5.0 rather than 5) or omitting a zero (for example .5 rather than 0.5). In both of these cases a faint decimal point may be overlooked. In addition, Hughes and Edgerton (2005) noted that the problems with miscalculations are due to "the inability to conceptualize the right mathematical calculations to be performed and understand the mathematical process leading to the solution", (pp. 81-2). Despite extensive literature demonstrating problems in nursing students' mathematical skills, we found few studies that even refer to the issues of students' *understanding* of the underlying mathematical principles and concepts behind the required calculations.

The task of comparing decimal numbers has been demonstrated to be a powerful tool to identify students with an incomplete or erroneous *conceptual* understanding of decimal numbers. Over the last two decades, researchers in various countries have used this task with students of varying ages to diagnose such misunderstandings. In Australia, for example, Steinle (2004) reported on the results of a longitudinal study involving several thousand students aged 10 to 16 years with such a diagnostic test. Stacey, Helme, Steinle, Baturu, Irwin and Bana (2001) used a similar test with over 500 pre-service teachers in four universities from Australia and New Zealand. Steinle and Stacey (2001) reported on a similar test with school students in Japan. Peled (2003) also used the task of decimal comparison as a diagnostic tool with 7<sup>th</sup> and 8<sup>th</sup> grade students in Israel.

We wish to use this well-established decimal comparison task to determine the extent of such problems within a sample of student nurses, both before and after a brief intervention designed to improve their conceptual understanding of decimal numbers.

## METHODOLOGY

This study was conducted with nursing students at an Australian university where the student nurses must attain 100% on a drug calculation test by the middle of their second year and maintain this skill level through to graduation. In March 2005, we

pre-tested 355 of these undergraduate nurses using a Decimal Comparison Test (DCT3a) based on the test reported by Steinle and Stacey (2001). The pre-test consisted of 30 items (pairs of decimal numbers) with the instruction “*For each pair of numbers, EITHER circle the larger number OR write = between them*”. The test was administered in the first ten minutes of a core subject lecture for each of years one to three and their results were posted on year level notice boards. Rather than a score being recorded next to student identification numbers, a diagnostic code was provided which classified any error patterns. Next to the results was an explanation of these codes and details regarding a free remedial session open to any nursing student.

Errors were identified for 109 students but only 13 students chose to attend a one-hour remedial intervention workshop in April. As a consequence of this low uptake, the decision was made to repeat the intervention in the first lecture of ‘Statistics for Nursing Research’, a course taken by some first and most second year students.

The remedial intervention, conducted by members of the research team, was constrained to a one-hour interactive lecture because, if adopted, such teaching would be an addition to an already crowded nursing curriculum. After illustrating the importance of decimals for nurses and providing reassurance that such problems are reasonably common, we explained that the tests revealed their difficulties with various items: items containing zero as a digit as well as zero as a number, decimals with repeated digits and decimals which are the same in the first two places. The teaching intervention therefore focussed on these items.

We began by demonstrating and then having the students join in the construction of physical representations of each number using Linear Arithmetic Blocks (LAB). As illustrated in Figure 1a, LAB allows the representation of decimals by length and encompasses measuring with different degrees of accuracy.

This was followed by more abstract representations such as the number slide shown in Figure 1b. A number slide is a powerful visual reminder of how the digits in a number move into the next largest place value column when a number is multiplied by 10, and move into the next smallest place value column when a number is divided by 10. Note that the intervention was designed to increase students’ conceptual understanding of decimal numbers and did not promote any specific procedures for comparing decimal numbers (such as examining digits from left to right).

A post-test containing 30 matched (and reordered) items was created; see Stacey and Steinle (submitted) for full details. A total of 256 students from the three year levels completed this post-test administered 12 weeks after the remedial intervention. A survey was included with the post-test, which asked students to indicate whether they had participated in our remedial intervention or spent any other time specifically working on decimals. Those who attended the intervention were also asked to give written feedback.

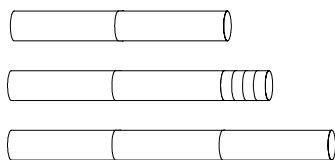

a) Comparing 2 tenths (0.2) with 2 tenths and 4 hundredths (0.24) and 3 tenths (0.3)

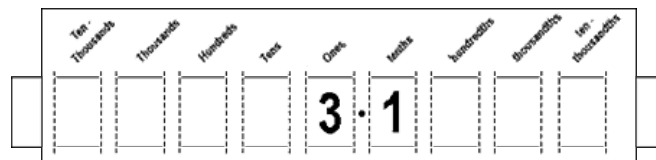

b) Number Slide

Figure 1: Representations of decimal numbers with LAB and Number Slide

Of the 355 students who sat the pre-test, 199 also sat the post-test. About half of the students who completed both tests achieved full marks on both occasions, and hence contribute no further data to this study. The key group of students of interest for this paper are the 96 students who sat both tests; made some errors; and furthermore completed a survey that indicated whether or not they took part in the intervention.

### RESULTS AND DISCUSSION

Table 1 indicates that 56% of the 355 students overall made no errors on their pre-test. There is some variation by year level, but, despite their prior achievement of 100% on at least one (if not two) drug calculation test(s), only 70% of the year 3 (final year) students completed the decimal comparison test without any errors.

Year	Total number of students	Number (percentage) of students with no errors	
1	127	65	(51.2%)
2	110	52	(47.3%)
3	118	83	(70.3%)
Overall	355	200	(56.3%)

Table 1: Number and percentage of students with no errors on pre-test by year level.

A full analysis of the difficulty of individual items on the pre-test is provided by Stacey and Steinle (submitted) but for the purposes of this paper, a brief analysis follows. Of the 30 test items, 23 items had error rates of less than 5%. In fact, the mean score for the students on these 23 items was 22.6, so these items presented almost no difficulty for these students. The remaining seven items, however, had error rates from 10% to 26%; see Table 2 for details. (Note that on the test paper, the number pairs are presented horizontally, but for reasons of space, they are listed here vertically.) The subsequent sections of this paper focus on these seven items.

Item #	Q9	Q10	Q19	Q20	Q26	Q29	Q30
Number	17.35	4.666	4.4502	3.7	0.8	0	0.7
Pair	17.353	4.66	4.45	3.77777	0.80000	0.6	0.00
Error Rate (n=355)	18%	26%	19%	25%	10%	15%	10%

Table 2: Error rates on seven items on pre-test.

Research had previously identified such items as causing difficulty for adult students. As mentioned earlier, these can be described as items that contain:

- zero as a digit (Q26);
- the number zero (Q29 & Q30);
- decimals with repeated digits (Q10 & Q20); and
- decimals which are the same in the first two places (Q9 & Q19).

The error rates on Q29 and Q30 are consistent with those found by Stacey et al (2001); here 16% of nursing students made an error on at least one of these two items compared with 13% of the pre-service teachers on three similar items. Furthermore, the high error rates on Q9, Q19, Q19 and Q20 are consistent with findings by Steinle and Stacey (2001).

As mentioned earlier, the students of interest in this study were those who completed both tests; made at least one error; and provided information in the survey that allowed us to identify students who had taken part in the intervention. Table 3 contains the mean pre- and post-test scores on the seven difficult items (listed in Table 2) for the 40 students who were involved in the intervention, as well as the 56 students who were not.

	Pre-test Mean (SD)		Post-test Mean (SD)		Improvement	t-test
Intervention (n=40)	4.5	(1.9)	5.6	(1.7)	1.1	$p=0.008$
No intervention (n=56)	4.9	(2.0)	4.8	(1.8)	-0.2	$p=0.561$

Table 3: Mean pre- and post-test scores on 7 items for 2 groups of students.

So, while the mean scores of the students in the intervention increased by 1.1, (statistically significant at the 0.05 level using a 2-tailed t-test), the mean scores for the non-intervention group decreased slightly (although not significantly).

An alternative analysis also provides evidence of improvement due to the intervention. Consider only the students who made some errors on the pre-test. Table 4 indicates that while 46% of such students in the intervention group made no errors on the post-test, only 23% of the non-intervention group did so. Furthermore, for the

19 intervention students who did make errors on the post-test, the average improvement was 1.5, compared with -0.2 for the 31 non-intervention students. Hence, the one-hour intervention resulted in increased test performance 3 months later.

	Pre-test: Number of students with errors	Post-test: Number (%) without errors	Post-test: Number (%) with errors
Intervention	35	16 (46%)	19 (54%)
No intervention	40	9 (23%)	31 (78%)

Table 4: Proportion of students with and without errors on post-test.

We acknowledge, however, that factors other than the intervention may have impacted on the students' understanding of decimals between the pre- and post-tests. For example, 45 students indicated on their survey that they had used the procedurally-focussed Nursing Calculations CD-ROM recommended by their teachers. The authors of this resource claim: "This nursing calculations CD-ROM comes with a very comprehensive set of notes that are built into the program that will teach you how to carry out all the relevant mathematical procedures with many worked full examples." The mean improvement for these 45 students on the 7 difficult items was 0.7 (SD 2.4). An Analysis of Variance test was performed on the change in score for the 7 difficult items, in order to distinguish between the effects of the two factors: intervention and use of CD-ROM. The results suggest that the intervention was a significant factor ( $p=0.017$ ) while use of the CD-ROM was not ( $p=0.324$ ). The interaction between the intervention and use of CD-ROM was also not statistically significant ( $p=0.334$ ).

Ideally the remedial intervention would be conducted as a workshop for those students who have been identified as having any difficulties, but constraints on this study meant that for many students it was conducted in a large group lecture. However, 40% of all students who attended an intervention and completed a survey (in fact, all 7 students who attended the workshop intervention and who completed a survey) reported that this teaching had changed their understanding of decimals.

The researchers observed a powerful and often verbalised 'ahha' response from students. During the workshop session students discussed their previous thinking and made the following comments:

- Student A mentioned thinking of decimals as being like negative numbers: 'when using a number line, decimals, are going the other way'.
- Student B said that her problems were with the repeating decimals. After the first digit after the decimal point she just 'cut' the rest of the digits, hence thinking 3.77777 as being the same as 3.7.
- Student C said she had difficulty deciding whether a blood alcohol reading of 0.12 was over the legal limit of 0.05 for driving

Students were positive about each of the learning materials used but especially the physical representation provided by LAB (see Figure 1a). All of the workshop group and some students from the lecture group were so pleased and excited by their new understanding that they made the unusual gesture of thanking the teachers at the conclusion of the session.

## CONCLUSION

Nurse educators recognise the importance of correct computation and interpretation in nursing calculations and fortunately most nursing students deal competently with decimals. Nurse educators report, however, that some students resit their drug calculation tests many times before they achieve 100% and then cannot repeat this score in subsequent tests. This study indicates that a significant number of students harbour fundamental misunderstandings of decimal numbers which are not identified by procedurally-focussed competence tests on drug calculations. These misunderstandings may lead to calculation and interpretation errors even when students follow correct procedural routines for nursing calculations. The lack of improvement on the post-test for students who used the Nursing Calculations CD-ROM suggests that such lack of conceptual knowledge is not remedied by procedural practice. The conceptual teaching in the one hour remedial intervention conducted in this study did produce both practically and statistically significant improvement.

The diagnostic results of this study, consistent with Stacey et al's (2001) earlier work, suggest that, for vocations where numeric accuracy has public importance, testing of adults should include conceptual items. Those students who have problems in this area should be required to participate in suitable conceptual remediation in addition to the procedurally-focussed teaching currently recommended in the literature. The use of concrete materials such as LAB and number slides is intended to increase conceptual understanding and not merely provide students with another routine procedure to follow. This should result in the long-term gain of increasing students' number sense, enabling them to make sense of the calculations, estimations and comparisons they will be faced with on a daily basis.

**Acknowledgements** Our thanks to other members of the project team: Kaye Stacey, Wanty Widjaja, Cecilia Sinclair and Nadine Gass; also to the staff and students of the School of Nursing, University of Ballarat.

## References

- BBC. (2005). <http://news.bbc.co.uk/1/hi/england/leicestershire/4566427.stm> (Accessed 4th January, 2006).
- Educational Innovations. (2002). *Nursing Calculations: A course to develop and assess skills in nursing calculations*. CD-ROM. Australia: General Relativity.
- Grandel-Niemi, H., Hulpi, M., & Leino-Kilpi, H. (2001). Medication calculation skills of graduating nursing students in Finland. *Advances in Health Science Education*, 6(1), 15-24.

- Hughes, R. G., & Edgerton, E. A. (2005). Reducing pediatric medication errors: children are especially at risk for medication errors. *American Journal of Nursing*, 105(5), 79-84.
- Lesar, T. (2002). Tenfold medication dose prescribing errors. *The Annals of Pharmacotherapy*, 36(12), 1833-1839.
- Peled, I. (2003) Improving decimal number conception by transfer from fractions to decimals. In N. Pateman, G. Dougherty, J. Zilliox (Eds.), *Proceedings of the 27th Conference of the International Group for the Psychology of Mathematics Education* (Vol. 4, pp. 1-6). Hawai'i: PME.
- Sabin, M. (2001). *Competence in practice-based calculation: issues for nursing education: A critical review of the literature*. Edinburgh: Napier University Edinburgh. <http://www.health.ltsn.ac.uk/publications/occasionalpaper/occasionalpaper03.pdf> (accessed 10th January 2006).
- Sander, T., & Cleary, S. (2004). Medication mathematics competency for bachelor of nursing students: results and challenges of a first year screening test. *Studies in Learning, Evaluation, Innovation and Development*, 1(2), 45-52.
- Stacey, K., & Steinle, V. (submitted). *Identifying decimal conceptions of adult students*.
- Stacey, K., Helme, S., Steinle, V., Baturo, A., Irwin, K., & Bana, J. (2001). Preservice Teachers' Knowledge of Difficulties in Decimal Numeration. *Journal of Mathematics Teacher Education*, 4(3), 205-225.
- Steinle, V. (2004). *Changes with Age in Students' Misconceptions of Decimal Numbers*. Unpublished PhD, University of Melbourne, Melbourne.
- Steinle, V., & Stacey, K. (2001). Visible and invisible zeros: Sources of confusion in decimal notation. In J. Bobis, B. Perry & M. Mitchelmore (Eds.), *Numeracy and Beyond. Proceedings of the 24th Annual Conference of the Mathematics Education Research Group of Australasia* (Vol. 2, pp. 434-441). Sydney: MERGA.



# PROPORTIONAL REASONING: VARIABLE INFLUENCING THE PROBLEMS DIFFICULTY LEVEL AND ONE'S USE OF PROBLEM SOLVING STRATEGIES

Olof Bjorg Steinhorsdottir

University of North Carolina in Chapel Hill

*This study was conducted to investigate the influence of contextual structure and number structure on individuals' use of strategies and success rate in solving missing value proportion problems. Fifty-three eighth graders in one school in Reykjavik, Iceland, participated in this study. Twenty-seven females and twenty-six males were individually interviewed as they solved sixteen missing value proportion problems. The problems number structure was carefully manipulated within planned parameters of complexity. The number complexity formed a parallel hierarchy among the contextual structure. The findings in this study indicate that number structure influenced strategy use and success to a greater extent than contextual structure.*

## BACKGROUND

Researchers have identified variables that contribute to an individual's ease or difficulty in solving proportion problems. Problem contextual structure<sup>1</sup> and number structure<sup>2</sup> are among these variables and therefore may influence one's use of problem solving strategy and problem difficulty level. Number structure and contextual structure exist side-by-side in proportional problems; both exert an influence on an individual's use of a solution strategy and problem difficulty level. In this study, I attempted to sort out these two factors to identify the extent of the influence of each on student's strategies and problem difficulty level in a population of fifty three eighth graders. Specifically I am asking: (1) how does problem contextual structure influence use of strategy and difficulty level within defined number structures, and (2) how does number structure influence use of strategy and difficulty level within defined contextual structure?

## Contextual Structure, Number Structure, Solution Strategies, and Proportion

The concept of ratio and proportion as applied by young people has been widely studied. Piaget and his collaborators identified proportionality within Piaget's stage of formal operational reasoning (Inhelder & Piaget, 1958). Some of Piaget's results have been criticized for the use of complex physical tasks to assess proportional reasoning, and therefore underestimate the influence of problem contextual structure.

---

<sup>1</sup> In this paper I will use the term Problem's contextual structure when referring to what the research calls problem context or semantic type. The reason why, is that the literature has used these two terms loosely and interchangeably.

<sup>2</sup> The number structure refers to the multiplicative relationship within and between ratios in a proportional setting.

---

2006. In Novotná, J., Moraová, H., Krátká, M. & Stehlíková, N. (Eds.). *Proceedings 30<sup>th</sup> Conference of the International Group for the Psychology of Mathematics Education*, Vol. 5, pp. 169-176. Prague: PME. 5 - 169

In an effort to examine the influence of contextual structure on solution strategies, Lamon (1993) developed a framework for classifying proportion problems, arguing that various “semantic types”<sup>3</sup> influence students’ reasoning. Lamon grouped problem situations into four categories: well-chunked measures, in which two measures are compared and the result is a commonly used rate (e.g., dollars per item, miles per hour); part-part-whole, in which the ratios compare two subsets of one whole set; associated sets, in which two elements are compared and their relationship is defined by the problem; and stretchers and shrinkers (or scaling problems). In individual clinical interviews with students, Lamon found the various contextual structures elicited different levels of sophistication in solution strategies and differences in levels of difficulty. It is not obvious from her study, however, if or how she controlled the number structure used in her problems or what influence number structure had on her results.

Five main difficulty factors are associated with number structure: (a) presence or absence of integer ratios, (b) placement of the unknown number, (c) numerical complexity (i.e., the size of the numbers used and the size of the ratios) and, (d) equal/unequal ratio (i.e. the presence or absence of a repeated difference between the measurement used), and (e) quantity (i.e. continuous vs. discrete; Abromowitz, 1975; Freudenthal, 1983; Karplus et al., 1983; Tourniaire & Pulos, 1985). The literature on proportional reasoning reveals a broad consensus that proportional reasoning develops from qualitative thinking to build-up strategies to multiplicative reasoning (Behr, Harel, Post, & Lesh, 1992; Inhelder, & Piaget, 1958; Kaput & West, 1994; Karplus et al., 1983; Kieren, 1993; Noelting, 1980a, 1980b; Resnick & Singer, 1993; Thompson, 1994). These strategies represent different levels of sophistication in thinking about proportions. Research with preadolescent students indicates that students’ representation of situations involving ratio and proportion occur on an informal, qualitative basis long before students are capable of treating the topic quantitatively. This strategy is characterized by the use of comparison words such as, bigger and smaller, more or less, to relate to the quantities in question (i.e. papa bear eats more than baby bear). (Behr, Harel, Post. & Lesh, 1992; Kieren, 1993; Resnick & Singer, 1993).

Build-up reasoning is an attempt to apply knowledge of addition or subtraction to proportion. To use the strategy, a child notes a pattern within a ratio and then iterates it to build up additively to the unknown quantity. This appears to be the dominant strategy for many students during childhood and adolescence (Tourniaire & Pulos, 1985). The build up strategy can be used successfully to solve problems with integer ratios but can lead to error if applied to noninteger problems. The multiplicative relationship can be integer or noninteger. For example, the problem  $\frac{2}{4} = \frac{12}{x}$  has integer multiples both within the given ratio ( $2 \times 2 = 4$ ) and between ratios ( $2 \times 6 = 12$ ). In a noninteger ratio occur when at least one of the multiplicative relationships (within the given ratio or between the two ratios) is not an integer. For example, the problem  $\frac{8}{5} = \frac{48}{x}$  has an integer multiple between the two ratios ( $8 \times 6 = 48$ ) but the within-ratio

<sup>3</sup> Lamon uses the term “semantic types” when referring to the various problem types.

relationship is noninteger ( $8 \times \frac{5}{8} = 5$  or  $5 \times 1\frac{3}{5} = 8$ ) (Abromowitz, 1975; Freudenthal, 1983; Karplus et al., 1983) Error strategies in proportional reasoning have been documented in the literature. Two types of error strategies have been frequently observed. The first error strategy is when students ignore part of the information given in the problem. A second type of frequently used error strategy is the ratio differences, sometimes called additive strategy. In this strategy, students use the difference between the numbers within a ratio or between the ratios and then apply this difference to the second ratio to find the unknown (Inhelder & Piaget, 1958; Tournaire & Pulos, 1985). The ratio difference is often use as a fall-back strategy when dealing with a noninteger ratio. A student might also use the ratio difference when treating the remainder in a problem (Karplus, Pulos, & Stage, 1983; Tournaire & Pulos, 1985).

## METHOD AND ANALYSIS

The population for this study consisted of 53 eighth-grade students in one school in Reykjavik, Iceland (27 females, 26 males). This school is one of the largest compulsory schools in Reykjavik. Families with a wide range of income live in the neighbourhood, ranging from government supported housing project for low income families and single parent families to upper middle class families. The school had four 8th classes, each with a different mathematics teacher. They were all mixed ability classes, with approximately same number of females and males. I randomly selected two of the four classes to participate in the study. All students of the two classes except one gave permission to be interviewed. Each of the 53 students was interviewed individually by me and audiotape. The students were asked to solve 16 missing value proportional problems. Field notes were taken to capture students reasoning. Individual students required between forty to eighty minutes to complete the 16 problems. The 16 problems were categorized by contextual structure and number structure. The problems represented Lamon's (1993) categorization: Well chunked (W-C), part-part whole (P-P-W), associated sets (A-S), and symbolic (S-P), in which two ratios are presented in mathematical symbols  $\left(\frac{3}{7} = \frac{x}{28}\right)$  and compared

without context. Four problems were in each category, each representing a distinct number structures: Integer relationship both within and between ratio and with an integer answer (I-I-I); integer relationship either within a ratio or between ratios with an integer answer (I-N-I or N-I-I), noninteger relationship both within and between ratio an integer answer (N-N-I), or noninteger relationship both within and between ratio a noninteger answer (N-N-N). The sixteen problems were presented in a random but predetermined order. Students were provided with paper and they were repeatedly encouraged to describe their thinking, whether in writing, drawing, orally, or a combination of these. An individual's response to each problem was analysed according to the strategy they used. Table 1 outlines the six categorizations, which form a hierarchy of reasoning sophistication, used for coding. After classifying the strategy used in each student response according to Table 1, I organized the results,

first by contextual structure and then by number structure. I also classified the number of correct answers, by contextual structure and by number structure.

<b>Strategies</b>	<b>Description of Strategies</b>
No Conception	No attempt to solve a problem or use numbers randomly
Qualitative	The numerical relationships are used for estimation.
Ratio Difference	The difference between the numbers in the known ratio is used to create a second ratio with the same difference. .
Build-up	The known ratio is additively built up to reach a target number (the known number of the second ratio).
Combined	Multiplication is used to get near a target number (the known number of the second ratio), but resorted to build-up, ratio difference, or qualitative thinking to adjust for non-integer multipliers.
Multiplicative	Multiplicative reasoning either within or between measure spaces to achieve a solution.

Table 1: Students' Strategies for Solving Missing Value Proportional Problems

## **RESULTS AND DISCUSSIONS**

Contextual Structure and Strategies. There are three contextual structures from which the students constructed different understandings of missing value proportional problems (Table 2). First, W-C problems and A-S problems call for similar interpretation and the pattern of strategy use is very similar. On the other hand, the P-P-W problems and the symbolic problems indicate a somewhat different pattern of strategy use. In the W-C and the A-S problems, students used less multiplicative and ratio differences strategies than build-up and combined strategies than in the other two contextual structures. Forty six percent of the W-C and 51% of the A-S problems were solved by multiplying and 31% of the W-C and 30% of the A-S were solved with combined strategy. The overall frequency of build-up strategy was small. However, the A-S and W-C problems elicited the most frequency of build-up strategies or 80%.

For the P-P-W problems, students tended to rely on a ratio differences strategy if they could not successfully use a multiplicative strategy. Fifty five percent of the problems were solved with multiplicative strategies whereas 20% were solved with ratio differences strategies. The students used very few build-up strategies solving the P-P-W problems, 4%. The symbolic problems had the highest use of multiplicative strategies; 67% were solved with multiplicative strategies. Similar, to the P-P-W problems, the students used ratio differences strategies when multiplicative strategies failed or 10% of the solutions. No student used build-up strategies for these problems. The symbolic problems also elicited that lowest rate of combined strategies, with only 13% of the solutions used combined strategies.

Strategies	Contextual Structure			
	Well Chunked	Part-Part-Whole	Associated Sets	Symbolic Problem
No conceptualization	10%	4%	7%	7%
Qualitative	0%	1%	0%	2%
Ratio Difference	6%	20%	4%	10%
Build-up	8%	4%	8%	0%
Combined	31%	16%	30%	13%
Multiplicative	46%	55%	51%	67%

Note. Well-Chunked, Associated Sets, and Symbolic Problem; total  $n=212$ ; Part-Part-Whole; total  $n=159$  ( $n$ =number of problem solved in each semantic type). Column does not add up to 100 due to rounding error

Table 2: Total Percentage of Strategies Used by Contextual Structure

The combined strategy was over 90% a combination of a multiplicative strategy and a less sophisticated strategy. In these tasks, many students used multiplication to attempt to reach a target number (the known part of the second ratio). When this number could not be reached with an integer multiplier, students used the nearest multiplier and applied a less sophisticated strategy on the remainder.

The findings of this study indicate that there was a difference in dealing with this remainder between contextual structures, therefore different combination of strategies. In 35% of the cases in combined strategies in both A-S and W-C, students found the remainder using the build-up strategy. About 11% of cases did students use ratio differences to deal with the remainder.

Sixteen percent of the P-P-W problems were solved with a combined strategy. The pattern of the combined strategies was also different. Only 4% of student's solutions used build-up strategies to deal with the remainder compared with 35% in the W-C and A-S problems. Twenty-four percent used ratio differences to deal with the remainder. The combination of strategies used in the symbolic problems was also different from the others. In 21% of solutions used build-up strategies, and 50% of the cases accounted for ratio differences dealing with the remainder.

Number Structure and Strategy. A clear pattern occurred of decreased usage of multiplicative strategies and increased usage of ratio differences as the number structure became more difficult (Table 3). For the I-I-I problems, students used multiplicative strategies in 82% of all cases. The percentage of problems solved with a multiplicative strategy decreased as the number structure became more complex, falling from 82% for the I-I-I problems to 25% for the N-N-N problems. The use of combined strategies increased as the numbers got more complex. In solving the I-I-I problems, no one used combined strategies, but in the N-N-N strategy, 50% of all the N-N-N problems were solved with combined strategies. There was also an increased use of ratio differences. Combined strategies also differed among number structures. No combined strategies were used in the I-I-I problems, simply because there was no remainder to handle. Ten percent of strategies in the I-N-I and N-I-I category were combined strategies. Of them 73% used build-up or multiplicative strategies to find the remainder. Ten percent of the students used ratio differences for the remainder

and fourteen percent dealt with the remainder by unitizing it and then adding it to the target number.

In the N-N-I problems 65% of the problems solved with a combined strategy used a build-up strategy for the remainder, 11% of the problem solved used estimation, 13% ratio differences, and in 9% of the problem the remainder was ignored. In the N-N-N problems, 43% of the problems that were solved with combined strategies used multiplicative strategy and estimation. Twenty-seven percent of the problem solved used ratio differences to find the remainder, 27% of problem solutions used a build-up strategy to deal with the remainder.

Strategies	Number Structure			
	I-I-I-	I-N-I or N-I-I	N-N-I	N-N-N
No conceptualization	4%	7%	11%	8%
Qualitative	0%	0%	3%	1%
Ratio Difference	5%	7%	10%	16%
Build-up	9%	4%	6%	1%
Combined	0%	10%	34%	50%
Multiplicative	82%	72%	36%	25%

Note. I-I-I and I-N-I and N-N-N total n=212; N-N-I: total n=159 (n=number of problems solved in each number structure category)

Table 3: Total Percentage of Strategies Used by Number Structure

Correct and Incorrect Answers. Number structure most clearly determines the difficulty level of missing value proportion problems. The number structure of the problems in this study clearly affected students' abilities to respond with correct answers more so than contextual structure (see Table 4.) Students did better on the A-S problems than any of the other or seventy three percent of correct solutions. The other contextual structures were all quite similar. On the other hand, if we look at the correct answers by number structure (Table 5); I-I-I problems were clearly the easiest with ninety two percent correct solutions. N-N-N problems were the most difficult ones, with only thirty two percent of all the N-N-N problems solved correctly.

Semantic Types	Gender		
	Female	Male	Total
Well- Chunked	66%	70%	68%
Part-Part Whole	57%	71%	64%
Associated Sets	74%	71%	73%
Symbolic Problem	68%	63%	65%

Note. Well-Chunked, Associated Sets, and Symbolic Problem: female n=108; male n=104; total n=212, Part-Part-Whole: female n=81; male n=78; total n=159 (n=number of problem solved in each number structure category). Columns do not add up to 100 due to rounding error

Table 4: Percentage of Correct Responses by Contextual structure

Number Structure	Gender		
	Female	Male	Total

I - I - I	92%	91%	92%
I - N - I or N - I - I	82%	88%	85%
N - N - I	60%	59%	60%
N - N - N	31%	34%	32%

Note. I-I-I and I-N-I and N-N-N female n=108; male n=104; total n=212; N-N-I: female n=81; male n=78; total n=159 (n=number of problem solved in each number structure category). Columns do not add up to 100 due to rounding error

Table 5: Percentage of Correct Responses by Number Structure

## DISCUSSION AND CONCLUSIONS

The purpose of this study was to identify whether the contextual structure or the number structure of missing-value proportion problems has a greater influence of student's choice of solution strategy and the problem difficulty level. The major findings of this study are: (1) the number structure influenced student's use of strategies more than did contextual structure; and (2) the number structure determines the level of difficulty of the problem. Well-chunked and associated sets problem elicited the fewest number of multiplicative strategies and highest number of combined strategies. However, since combined strategies were always a combination of multiplicative strategy and one other strategy it can be argued that W-C and A-S elicited the most frequent use of multiplicative strategies. The number of correct solutions supports that interpretation, since W-C and A-S problem had the highest success rate.

P-P-W problems showed the lowest number of multiplicative strategies and most frequent use of ratio differences strategies. For symbolic problems students used mostly multiplicative strategies. Build-up strategies were not used while there were no concrete elements to build-up. The data suggest that students used their most mature strategies on the problems which they clearly understand and could easily explain. The easiest problems for students to solve were I-I-I tasks and the most difficult problems were the N-N-N tasks. Students' strategies varied according to problem difficulty. All students used multiplicative strategies on the I-I-I and most students on the I-N-I / N-I-I problems, but many resorted to less sophisticated reasoning on the N-N-I and N-N-N problems. Frequent use of multiplicative strategies when solving the I-N-I / N-I-I problems can be interpreted in two ways. First, students did indeed find the "easiest" way and looked for the integer relationship in the problem. Secondly, the noninteger relationship was a half relationship and for students half is a familiar easily applied fraction. One explanation for why the half relationship in the N-N-I problems did not show the same success as in the I-N-I / N-I-I problems is that the size of the numbers used in the N-N-I problems were larger than in the other number structures. The last number structure N-N-N, showed the fewest cases of correct solutions as well as the least usage of multiplicative strategy. It could be argued that for some of the students, finding an exact answer was not a feasible way of solving the problem. A close estimate made more sense to some students than a noninteger answer.

## References

- Abramowitz, S. (1975). *Adolescent Understanding of Proportionality: The Effects of Task Characteristics*. Study undertaken as a doctoral dissertation at Stanford University: Palo Alto, CA
- Behr, M., Harel, G., Post, T., & Lesh, R. (1992). Rational number, ratio, and proportion. In D. Grouws (Ed.), *Handbook of Research on Mathematics Teaching and Learning*, (pp. 296-333). New York: Macmillan.
- Freudenthal, H. (1983). *Didactical phenomenology of mathematical structures*. Dordrecht, the Netherlands: D. Reidel.
- Inhelder, B., & Piaget, J. (1958). *The Growth of Logical Thinking from Childhood to Adolescence*. New York: Basic Books.
- Kaput, J., & West, M. (1994). Missing value proportional reasoning problems: Factors affecting informal reasoning patterns. In G. Harel & J. Confrey (Eds.), *The Development of Multiplicative Reasoning in the Learning of Mathematics* (pp. 235-287). Albany, NY: State University of New York Press.
- Karplus, R., Pulos, S., & Stage, E. K. (1983). Proportional reasoning of early adolescents. In R. Lesh & M. Landau (Eds.), *Acquisition of Mathematics Concepts and Processes* (pp. 45-90). Orlando, FL: Academic Press.
- Kieren, T. (1993). Rational and fractional numbers: From quotient fields to recursive understanding. In T. Carpenter, E. Fennema, & T. Romberg (Eds.), *Rational Numbers: an Integration of Research* (pp. 49-84). Hillsdale, NJ: Lawrence Erlbaum.
- Lamon, S. (1993). Ratio and proportion: Connecting content and children's thinking. *Journal for Research in Mathematics Education*, 24(1), 41-61.
- Noelting, G. (1980a). The development of proportional reasoning and the ratio concept. Part 1 - Differentiation of stages. *Educational Studies in Mathematics*, 11, 217-253.
- Noelting, G. (1980b). The development of proportional reasoning and the ratio concept. Part 2 - Problem-structure at successive stages; Problem solving strategies and the mechanism of adaptive restructuring. *Educational Studies in Mathematics*, 11, 331-363.
- Resnick, L. (1983). Mathematics and science learning: A new conception. *Science*, 220, 477-478.
- Resnick, L. B., & Singer, J. A. (1993). Protoquantitative origins of ratio reasoning. In T. Carpenter, E. Fennema, & T. Romberg (Eds.), *Rational Numbers: an Integration of Research* (pp. 107-130). Hillsdale, NJ: Lawrence Erlbaum.
- Tourniaire, F., & Pulos, S. (1985). Proportional reasoning: A review of the literature. *Educational Studies in Mathematics*, 16, 181-204.
- Vergnaud, G. (1994). Multiplicative conceptual field: What and why? In G. Harel & J. Confrey (Eds.), *The Development of Multiplicative Reasoning in the Learning of Mathematics* (pp. 41-59). Albany, NY: State University of New York Press.



# THE IMPACT OF THE INTUITIVE RULE “IF A THEN B, IF NOT A THEN NOT B”, IN PERIMETER AND AREA TASKS

Lambros Stephanou & Demetra Pitta-Pantazi

University of Cyprus, Department of Education

*The aim of this study is to investigate the impact of the intuitive rule “if A then B, if not A then not B”, in upper primary school students’ responses in area and perimeter tasks. The results show that in these tasks a significant percentage of students respond in line with the above mentioned intuitive rule, irrespective of their sex, grade level, context of the task (perimeter/area) and presence or absence of a diagram.*

## INTRODUCTION

Knowledge of students’ mathematical errors and even more importantly reasons for which students make these errors in mathematics play an important role in the teaching and design of instruction. However, although the description of students’ errors may be quite simple, the identification of reasons for which students make these errors is a more complicated task. Within the field of mathematics education a number of researchers have offered a variety of theoretical frameworks which explain the reasons for which students make these errors: the notion of epistemological obstacle (Brousseau, 1997), the improper use of analogy (Brousseau, 1997), the theorem-in-action (Vergnaud, 1998), the illusion of linearity (Van Dooren, De Bock, Depaepe, Janssens, & Verschaffel, 2003), the conceptual change (Vosniadou, 2004).

In this study we will explore the responses given to area, perimeter tasks under the lens of the intuitive rule theory (Stavy & Tirosh, 2000). More specifically we will investigate the impact of the intuitive rule “if A then B, if not A then not B” in upper primary school students’ responses in area and perimeter tasks, a rule that has been identified by Stavy and Tirosh (2000) but has received the least research attention.

## THEORETICAL FRAMEWORK AND PURPOSE OF THE STUDY

### The intuitive rules theory

Fischbein defines an intuition as an immediate cognition that exceeds the given facts, as “a theory that implies an extrapolation beyond the directly accessible information” (Fischbein, 1987, p.13). According to Fischbein (1987) such an intuition is characterized by self-evidence, intrinsic certainty, coerciveness, extrapolativeness and globality. Based on Fischbein’s work concerning the role of intuition in mathematics and science, Stavy and Tirosh (2000) proposed the theory of intuitive rules in an attempt to explain and predict students’ responses to mathematics and scientific tasks. According to their theory, “the human responses are determined mainly by irrelevant external features of the tasks, not by related concepts and ideas” (Stavy & Tirosh, 2000, p. 85). Of course, they acknowledge that the impact of these

external task characteristics depends to a certain extent to solver-related characteristics (e.g., age, instruction).

Stavy and Tirosh (2000) believe that many responses described as alternative conceptions in the literature can be interpreted as evolving from several common, intuitive rules. They have so far identified three such rules: “More A-More B”, “Same A-Same B” and “Everything can be divided”, but they acknowledge that there may be other intuitive rules that are activated in other types of tasks. One such rule, which the two authors have presented in their book but until now has received very limited investigation is “if A then B, if not A then not B”.

### **The intuitive rule “if A then B, if not A then not B”**

The concepts of effect and result form the cornerstone of the intuitive rule investigated in this study. According to Piaget, the notion of effect and result begins from the sensorimotor stage of cognitive development. Specifically, in the age of 1 to 4 months, a child may not be able to establish a link between an effect and its result, but the acknowledgement of the presence of such a relation begins to appear. A clear understanding of which effects cause an event occurs later at the age of 10 to 12 months (Salkind, 1999).

In other words, from the early childhood we think about causal relations because they allow us to infer what will happen. For example, “striking a match causes its lighting, because if it hadn’t been struck, it wouldn’t have lit” (Bigaj, 2005, p. 599). The claim above is problematic since there are other ways to light a match without striking.

This idea is thoroughly examined by Rueger (1998) in his analysis of the causal relationship. According to the author (p. 27): “Suppose event E is brought about by a process P, a chain of events, originating in event C but that there is an alternative chain P1 which would have brought about E in case P hadn’t succeeded. For an analysis of causation in terms of counterfactual dependence of E on C – ‘If C hadn’t occurred, E would not have happened’ – this case constitutes a problem because the existence of an alternative causal path leading to E, even though it actually remains idle (P doesn’t happen), destroys the counterfactual dependence of E on C. P, therefore, is not classified as a causal process leading from C to E”.

De Villiers (1998) considers the understanding of the logical structure “if-then” to be very important in the development of students’ ability to define geometric concepts like the quadrilaterals. It is conjectured that life experiences combined with instruction may lead students to an overgeneralization of the logical structure “if-then”. The result of such overgeneralization is the rejection of the “then” statement by the students when the “if” statement does not hold.

### **Perimeter and area tasks**

Research indicates that students have great difficulty explaining or illustrating ideas of perimeter and area, even in the middle grades (Chappell & Thompson, 1999).

Moyer (2001) points out that the most common errors that children make in reporting perimeter and area is in confusing units and square units. Likewise, Kouba et al. (1998) found that children in grade 3 confuse area to perimeter, hence the most common error they made when asked to calculate the perimeter was to calculate the area, and vice versa. Furthermore, Stavy and Tirosh (2000) found that for a significant percentage of students a predictable relationship between area and perimeter is that when the area of a shape decreases/increases, the perimeter will also decrease/increase. In addition, it is reported that often students think that shapes with the same perimeter must have the same area, and vice versa (Stavy & Tirosh, 2000). In this study we claim that some errors that students do in specific area and perimeter tasks could be the result of the impact of the intuitive rule «if A then B, if not A then not B».

## **THE STUDY**

### **Participants**

A sample of upper primary school students were used in this study; 37 4<sup>th</sup> graders, 30 5<sup>th</sup> graders, and 35 6<sup>th</sup> graders. Of these 102 students, 60% were female and the remaining 40% were male.

### **Tasks**

For the collection of data, we used the responses of the students to two multiple choice tests that were augmented by a justification section. Prior to the administration of the tests, we verified that the students knew the concepts of area and perimeter and were able to compute them for a given rectangle, so that the investigation of the intuitive rule “if A then B, if not A then not B” would make sense.

The first test consisted of four tasks. In two of the tasks, the students were asked to say what would happen to the area or the perimeter of a rectangle when both dimensions changed. In the other two tasks, the students were asked to say what would happen when only one dimension changed.

The second test consisted of four isomorphic tasks to the first test. Each task represented an identical problem to the corresponding task of the first test but with different dimensions and the addition of a diagram. The diagram depicted the rectangle under consideration, its dimensions and its perimeter or area.

The students were given four choices: (a) the area/perimeter will change, (b) the area/perimeter sometimes changes and sometimes remains the same, (c) the area/perimeter remains the same, and (d) other. In the tasks where both dimensions changed, the intuitive rule supported the selection of choice (a), a false answer, whereas the correct answer was choice (b). In contrast, in the tasks where only one dimension changed, the intuitive rule supported the selection of the correct answer which was choice (a).

**PRESENTATION OF THE RESULTS**

Table 1 below presents the responses of the students to the verbal and diagrammatic area and perimeter tasks where two dimensions changed. We observe that in these tasks 64% to 76% of the students responded in line with the intuitive rule that “the area/perimeter will change” and give a false answer. Moreover, 22% to 32% of the students gave the correct answer that “the area/perimeter sometime changes”.

	V-Area2 (n=102)	D-Area2 (n=102)	V-Perimeter2 (n=102)	D-Perimeter2 (n=102)
Changes	76	73	64	64
Sometimes changes*	22	22	31	32
Remains the same	1	5	3	4
Other	1	0	1	0
No answer	0	0	1	0

n=number of students, (\*) correct response

Table 1: Responses to the tasks where two dimensions change (in %)

In the case of tasks that only one dimension changed (see Table 2), 66% to 74% of the students correctly responded that “the area/perimeter will change”. Moreover, 19% to 25% incorrectly responded that “the area/perimeter sometimes changes”, an answer that was not expected, thus it was further investigated by the conduction of interviews. Our findings are presented later on in the paper.

	V-Area1 (n=102)	D-Area1 (n=102)	V-Perimeter1 (n=102)	D-Perimeter1 (n=102)
Changes*	74	71	71	66
Sometimes changes	21	22	19	25
Remains the same	2	6	7	8
Other	3	1	2	1
No answer	0	0	1	0

n=number of students, (\*) correct response

Table 2: Responses to the tasks where only one dimension changes (in %)

Our next objective was to examine whether the use of a diagram affected the students’ responses. For this purpose, we calculated correlations between the corresponding isomorphic tasks of the two tests. We found correlations that were positive and statistically significant among all cases. These results were further strengthened by the use of crosstabs calculations, which showed that around 80% of the students responded in the same way among all cases of isomorphic tasks.

The correlations also revealed that there were positive correlations among all tasks where both dimensions changed. Positive correlations also occurred among the tasks

where only one dimension changed. These observations have important implications in the understanding of the intuitive rule. We investigated this further by using factor analysis, which confirmed the findings of the correlations. More explicitly, two factors were identified that can explain 58,9% of the dispersion in the sample ( $F_1=30,2\%$ ,  $F_2=28,7\%$ ). The first factor includes the tasks where both dimensions changed, while the second includes the tasks where only one dimension changed.

We then checked to see whether sex and/or age influenced the application of the intuitive rule. We found that neither sex nor age had any influence. The sixth graders gave on average better answers than the other students, although this difference in correct responses was not statistically significant.

We now proceed to examine the justifications students gave for each answer. We found that in the tasks where both dimensions changed the justifications fell in three main categories (a, b, and c). We display the results for the case of the verbal tasks (test 1) in Table 3. The results from the diagrammatic test were very similar and thus omitted.

Response	Justification	Task	
		V-Ar.2 (n=102)	V-Per.2 (n=102)
Changes	a. Both dimensions are changing, therefore area/perimeter will change**	64	55
	b. There are no other numbers that provide the same area/perimeter	9	5
	Other justifications	3	2
	No justification		2
Sometimes changes	c. The area/perimeter sometimes changes and sometimes remains the same depending on the numbers*	16	23
	Other justifications	5	6
	No justification	1	2
	Other responses	2	4
No response		0	1

n= number of students, (\*) correct justification, (\*\*) justification in line with “If A, then B. If not A, then not B”

Table 3: Answers and justifications for Verbal Area and for Verbal Perimeter where two dimensions change (in%)

Looking at the table, the largest portion (64% and 55% respectively) of the students who selected the answer “the area/perimeter of the rectangle will change” argued that area/perimeter would change since the dimensions changed. We considered the justifications of the forms “length and width/dimensions/the shape/the rectangle

change(s), therefore the area/perimeter will change” to be roughly the same and hence, we have collapsed them in the same category (see justification a in Table 3).

In addition, only 16% and 23% of the students respectively, selected the correct answer, i.e. “the area/perimeter of the rectangle sometimes changes and sometimes stays the same” and gave the justification “the area/perimeter sometimes changes and sometimes remains the same depending on the numbers”.

We observe that 9% and 5% of the students in the area and perimeter tasks respectively, selected the answer “the area/perimeter will change” and give the justification “there are no other numbers that provide the same area/perimeter”. For us, this response is not in line with the intuitive rule and we attribute it to the fact that the students failed to find other numbers that could generate the same area/perimeter.

Similarly to the case of the tasks where both dimensions changed, in the tasks where only one dimension changed, the justifications given by the students also fall in three main categories (a, b, and c). We present the results in Table 4.

Response	Justification	Task	
		V-Ar.1 (n=102)	V-Per.1 (n=102)
Changes	a. The width/length is changing so the perimeter will also change	38	41
	b. There is no other number that provides the same perimeter*	26	21
	Other justifications	5	5
	No justification	5	4
Sometimes changes	c. The perimeter sometimes changes and sometimes remains the same because only the one dimension changes**	16	13
	Other justifications	5	3
	No justification		3
Other responses	Other justifications	5	9
No response		0	1

n= number of students, (\*) correct justification, (\*\*) justification in line with “If A, then B. If not A, then not B”

Table 4: Answers and Justifications for Verbal Area and for Verbal Perimeter where only one dimension changes (in %)

Specifically, 21% and 26% of the students selected the correct answer “the area/perimeter will change” and justified it by saying that “there is no other number that when multiplied by the other dimension that remains constant will yield the same area/perimeter”. This answer is not provoked by the intuitive rule. In contrast, 38% and 41% of the students, that gave the correct answer, justified it by saying “the

width/length is changing so the perimeter will also change”. This type of response does not allow us to see whether the answer was given due to correct reasoning or the impact of the intuitive rule.

Moreover, we observe that 16% and 13% of the students choose the justification “the area/perimeter of the rectangle sometimes changes and sometimes stays the same” and argue that “the perimeter sometimes changes and sometimes remains the same because only one dimension changes”. We find this unexpected justification to be in line with the intuitive rule. We presume that a significant portion of the students who select choice (b) are the most influenced by the intuitive rule. These students consider that the change in one dimension may not always have the same effect on the area/perimeter. Eight interviews took place to verify that similar justifications fall in category (c) and follow the intuitive rule. The interviews confirmed our assertion. An excerpt from a 5<sup>th</sup> grader’s interview was: *“Since both dimensions change, it is certain that the area will change. However, when only one dimension changes, it is not certain that the area will always change. It is simple. It is natural”*. This girl showed certainty and confidence for her answer and she felt that it was self-evident and did not need to give any further explanations.

## DISCUSSION AND CONCLUSIONS

The purpose of this study was to examine the influence of the intuitive rule “if A then B, if not A, then not B” in students’ responses. To our knowledge, this intuitive rule has not received much research attention. Focusing on upper primary school students, we found that a significant percentage of students respond in line with the above mentioned intuitive rule, irrespective of their sex, grade level, context of the task (perimeter/area) and presence or absence of a diagram. Its influence is evident in the justifications students gave. For the specific tasks implemented in the tests, the intuitive rule influenced 54% to 64% of the students depending on the task.

To check the robustness of these findings we applied factor analysis that identified two factors which explain nearly 60% of the dispersion. The first factor includes the tasks where both dimensions change, while the second factor includes the tasks where only one dimension changes. The identification of these two factors shows that students are influenced not so much by the specific context of a task (area or perimeter) or the presence of a diagram, but rather they are influenced by the external features (change of one/both dimensions) of the task that trigger the intuitive rule “if A then B, if not A then not B”. These findings further support the belief that “human responses are determined mainly by the irrelevant external features of the tasks, not by related concepts and ideas” (Stavy & Tirosh, 2000, p. 85).

Identifying the intuitive rule above is essential for the teaching and design of instruction. Knowledge of how this intuitive rule works allows the teacher to understand the source of a range of mistakes students make in specific tasks and help students overcome the effect of the intuitive rule. Furthermore, the teacher can predict the tasks that trigger the intuitive rule and hence, help the students focus more

on the specific context of a given task and less on external characteristics through proper instruction.

This study is limited by the small sample examined. Ideally we would like to have a larger sample and expand the setting to include students not only from the upper primary school but also from other grades. This will give us more power in the statistical inferences and also it will enable us to investigate further the effect of age in the influence of this intuitive rule. Finally, we would like to expand the number of tasks in order to cover a broader area of mathematics. This is the objective of a current ongoing project by the authors that may eventually lead to a better understanding of the intuitive rule “if A then B, if not A then not B”.

## References

- Bigaj, T. (2005). Causes, conditions and counterfactuals. *Axiomathes*, 15(4), 599-619.
- Brousseau, G. (1997). *Theory of didactical situations in mathematics*. Kluwer Academic Publisher.
- Chappell, M., & Thompson, D. (1999). Perimeter or Area? Which is it? *Teaching Mathematics in the Middle School*, 5(1), 20-23.
- De Villiers, M.D. (1998). To teach definitions in geometry or teach to define? In Olivier, A., & Newstead, K. (Eds.), *Proceedings of PME 22* (Vol. 2, pp. 248-255). South Africa: Program Committee of PME22.
- Fischbein, E. (1987). *Intuition in science and mathematics: An educational approach*. Dordrecht, The Netherlands: Reidel.
- Kouba, V.L., Brown, C.A., Carpenter, T.P., Lindquist, M.M., Silver, E.A., & Swafford, J.O. (1988). Results of the 4<sup>th</sup> NAEP Assessment of Mathematics: Measurement, geometry, data interpretation, attitudes and other topics. *Arithmetic Teacher*, 35(9), 10-16.
- Rueger, A. (1998). Local theories of causation and the a posteriori identification of the causal relation. *Erkenntnis*, 48(1), 27-40.
- Salkind, J.N. (1999). *Theories of human development*. (6th ed.). Athens: Patakis.
- Stavy, R., & Tirosh, D. (2000). *How students (mis)understand science and mathematics: Intuitive rules*. New York: Teachers College Press.
- Van Dooren, W., De Bock, D., Depaepe, F., Janssens, D., & Verschaffel, L. (2003). The illusion of linearity: Expanding the evidence towards probabilistic reasoning. *Educational studies in mathematics*, 53(2), 113-138.
- Vergnaud, G. (1998). A comprehensive theory of representation for mathematics education. *Journal of mathematical behaviour*, 17(2), pp. 167-181.
- Vosniadou, S., & Verschaffel, L. (2004). The Problem of Conceptual Change in Mathematics. In L., Verschaffel and S. Vosniadou (Eds.) *Conceptual Change in Mathematics Learning and Teaching*, *Learning and Instruction*, 14, 445-451.



# PROCESS-OBJECT DIFFICULTIES IN LINEAR ALGEBRA: EIGENVALUES AND EIGENVECTORS

Sepideh Stewart & Michael O. J. Thomas

The University of Auckland

*Many beginning university students struggle with the new approach to mathematics that they find in linear algebra courses. These courses may focus on conceptual ideas more than procedural ones, with the ideas arriving one after another and building upon each other in a rapid fashion. This paper highlights the example of the conceptual processes and difficulties students find in learning about eigenvalues and eigenvectors, where a word definition may be immediately linked to a symbolic presentation,  $Ax = \lambda x$ , and its manipulation. The results describe the thinking about these concepts of a group of first year university students, and in particular the obstacles they faced, and the emerging links some were forming between the parts of their concept images forming from embodied, symbolic and formal worlds.*

## INTRODUCTION

Many university students are introduced to the formal presentation of mathematics through a first course in linear algebra. Unlike calculus, that often emphasises manipulation of symbols in order to solve problems, the focus in linear algebra is on the description of concepts, often through word definitions, and derivation of further concepts from these. Considering the problems of understanding more advanced mathematics Tall (1998) described an *enactive* approach to learning about differential equations (DE's) in which one builds an *embodied* notion of the solution to a DE in contrast with an algebraic introduction that stresses analytic procedures without first giving a feeling for a DE and its solutions. In recent papers Tall (Tall, 2004a, b) has developed these ideas into a theory of the cognitive development of mathematical concepts. He describes learning taking place in three worlds: the embodied; the symbolic; and the formal. The embodied is where we make use of physical attributes of concepts, combined with our sensual experiences to build mental conceptions. The symbolic world is where the symbolic representations of concepts are acted upon, or manipulated, where it is possible to "switch effortlessly from processes to *do* mathematics, to concepts to *think* about." (Tall, 2004a, p. 30). Movement from the embodied world to the symbolic changes the focus of learning from changes in physical meaning to the properties of the symbols and the relationships between them. The formal world is where properties of objects are formalized as axioms, and learning comprises the building and proving of theorems by logical deduction from the axioms.

The DE situation above is exactly analogous to what often happens when eigenvalues and eigenvectors are introduced to students. While the concept definition may be given in words the student is soon into manipulations of algebraic and matrix

---

2006. In Novotná, J., Moraová, H., Krátká, M. & Stehlíková, N. (Eds.). *Proceedings 30<sup>th</sup> Conference of the International Group for the Psychology of Mathematics Education*, Vol. 5, pp. 185-192. Prague: PME. 5 - 185

representations, e.g. transforming  $Ax = \lambda x$  to  $(A - \lambda I)x = 0$ . In this way the strong visual, or embodied metaphorical, image of eigenvectors is obscured by the strength of this formal and symbolic thrust. However, an enactive, embodied approach would first give a feeling for what eigenvalues, and their associated eigenvectors are, and how they relate to the algebraic representation. Such linking of multiple representations of concepts is an important idea, and it has been suggested that ‘a central goal’ of mathematics education should be to increase the power of students’ representations (Greer & Harel, 1998, p. 22). Developing the *representational versatility* (Thomas & Hong, 2001; Thomas, in press) to make the links between the concepts of scalar, vector, equation, eigenvalue, and eigenvector, and their algebraic, matrix and geometric representations is not automatic, and yet often students are asked to deal with this before they have been introduced to linear transformations, as is the case in computation-to-abstraction linear algebra courses (Klapsinou & Gray, 1999). When we begin to consider how each of these concepts arises then things get more complicated. Dubinsky and others (Cottrill, Dubinsky, Nichols, Schwingendorf, Thomas, & Vidakovic, 1996; Dubinsky, & McDonald, 2001) have described how actions become interiorised as processes that in turn may be *encapsulated* as objects, forming part of a schema. One serious problem with  $Ax = \lambda x$  for students is that the two sides of the equation are quite different processes, but they have to be encapsulated to give the same mathematical object. In the first case the left hand side is the process of multiplying (on the left) a vector by a matrix; the right hand side is the process of multiplying a vector by a scalar. Yet in each case the final object is a vector that has to be interpreted as the product of the eigenvalue and its eigenvector. A second difficulty may be that the symbolic manipulation process may be obscuring understanding of the concept of eigenvector. Explanations of what an eigenvector is start with it as an object and then explain the effect of performing actions upon it; applying a transformation to it and multiplying it by a scalar. However, to find the eigenvector one must first find its associated eigenvalue, holding in obedience any action it will perform upon the eigenvector until it’s found. In this paper we use Tall’s three worlds to analyse the way that some students think about these concepts and how they cope with the cognitive obstacles described above.

## METHOD

This research study took place in early 2005 and comprised an initial case study of first year Maths 108 mathematics and science students from The University of Auckland. Maths 108 is a first year computation-to-abstraction course covering both calculus and elementary linear algebra (systems of linear equations, invertibility of matrices, determinants, eigenvectors, eigenvalues and diagonalisation). The first-named author was one of the lecturers on the course, and she tried to emphasize a geometric, embodied approach. During the linear algebra lectures she took the students for a tutorial in a computer laboratory on two occasions and showed them how to use Maple for linear algebra. After this the students were given a questionnaire that asked them about their attitude to linear algebra (and Maple). Finally, at the end of the linear algebra lectures a written test on eigenvalues and

eigenvectors was given to a group of 10 students who volunteered to take part in the research. Of these students six (numbered 1-6 below) had attended the researcher's lectures, while the rest attended other streams. The test (see Figure 1 for some of the questions) was not designed to assess course progress but was primarily to examine the students' understanding of the concepts of eigenvectors and eigenvalue, and their ability to carry out the process of finding them for a given  $2 \times 2$  matrix (see question 2).

### Maths 108 Questions

1. Describe the definitions of eigenvalues and eigenvectors in your own words.
2. Let  $A = \begin{pmatrix} 1 & 2 \\ 4 & 3 \end{pmatrix}$  be a  $2 \times 2$  matrix. What are the eigenvalues and eigenvectors of matrix  $A$ ?
3. Suppose  $A$  is a matrix representing a transformation and:  $A \begin{pmatrix} 1 \\ 2 \end{pmatrix} = 3 \begin{pmatrix} 2 \\ 3 \end{pmatrix}$ . What does this tell us about the 3? Describe this geometrically.
4. How can we decide whether a given vector is an eigenvector of a matrix? Explain this in your own words.
8. How many different eigenvectors are there associated with a given eigenvalue?
11. Describe what the following diagram may represent as best as you can.

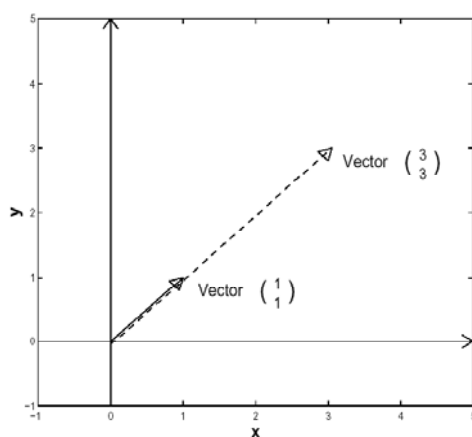

Note: Question 2 is a worked example in the course manual.

Figure 1. The questions from the test discussed in this paper.

## RESULTS

Eigenvectors and eigenvalues probably form the most difficult part of Maths 108 linear algebra course. Students may not agree, since they often focus on solution procedures rather than conceptual understanding. So in the questionnaire we asked

them what they thought was the most difficult idea in the linear algebra course. While many students mentioned the somewhat involved procedures of row reduction and calculating inverses of matrices, etc., student 2, among others agreed with us.

Student 2: Eigenvalues and eigenvectors, yes Maple help me understand how to get the eigenvectors from eigenvalues.

Student 11: Inverse, eigenvalues, eigenvectors. Tutorial sessions helped. Continued computer sessions will help me more.

### Indications of an embodied perspective

There were some indications in the test responses of the students that they were using the embodied world to help build their thinking about eigenvalues and eigenvectors. For example question one asked them to describe the definition of the terms in their own words. Three of the students (1, 6, 8) mentioned the idea of the ‘direction’ of a vector. Although student 1 did not use it correctly, the other two had a clearer embodied aspect to their concept image of eigenvector.

Student 6: After transformation the direction of eigenvectors will not change.

Student 8: Eigenvector is a vector which does not change its direction when multiplied (or transformed) by a particular matrix. An eigenvector can change in length, but not in direction.

We see that student 8 has also added the embodied notion of change of length to her thinking. While the other students who answered the question referred to the procedural, symbolic manipulations in their answers, two of them had formed a mental model of the structure of this too (see Figure 2).

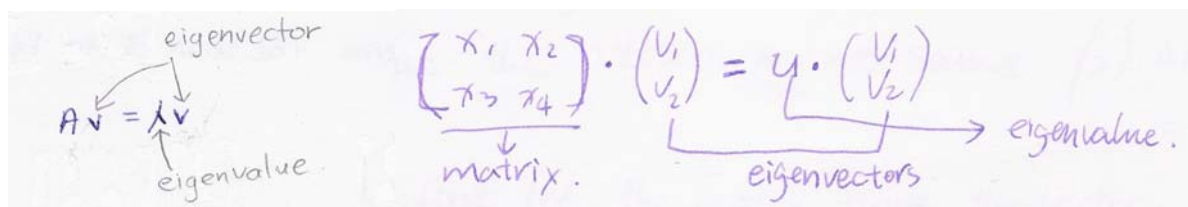

Figure 2. Students 5 and 9 use a structural model of the algebra.

In answering question 3 we also saw examples of the embodied nature of the students’ thinking. Student 1 explains that “the eigenvalue changes the vector’s direction. ie more steep.”, using the embodied notions of ‘change of direction’ and ‘steepness’.

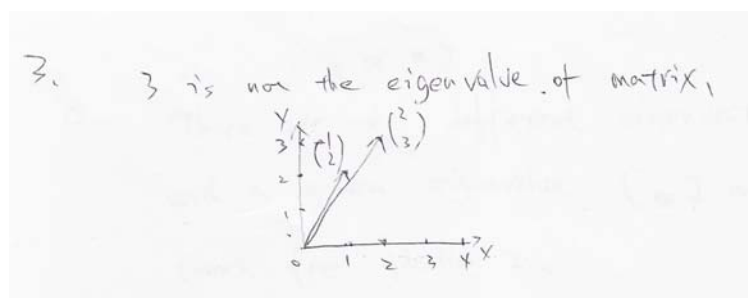

Figure 3. Student 6’s embodied notions of ‘change of direction’ and ‘steepness’.

Student 4 also said that “3 is not an eigenvalue of the equation. Hence it changes the direction of the original vector.” Student 6 has a similar recourse to the embodied idea of change of direction of the vector, drawing the picture in Figure 3. In question 4, students 4 and 8 also referred to the idea of direction to decide on whether a vector is an eigenvector. In question 11, all the students except 7 and 10 linked the diagram to a vector (1, 1), an eigenvalue of 3 and a final vector (3,3). In doing so they again used embodied terms such as “being stretched” (1), “it makes eigenvector longer” (3), and “stretch the length of (1, 1)” (5). It seems that the researcher’s students did make more use of embodied ideas than the others.

### Conceptual process problems

As we have described above there is a possible tension in  $Ax = \lambda x$  between the process of matrix multiplication on the left and the scalar multiplication on the right, both resulting in the same object of the transformed vector.

$$\begin{aligned}
 Av &= \lambda v \\
 Av &= \lambda v \\
 Av - \lambda v &= 0 \\
 (A - \lambda I)v &= 0 && \text{[note the use of } I \text{ here]} \\
 Bv &= 0 && \text{[where } B = A - \lambda I\text{].}
 \end{aligned}$$

4a.

$$\begin{aligned}
 \begin{pmatrix} 1 & 2 \\ 4 & 3 \end{pmatrix} b &= \begin{pmatrix} 5 & 0 \\ 0 & 5 \end{pmatrix} b \\
 \begin{pmatrix} -4 & 2 \\ 4 & -2 \end{pmatrix} b &= 0 \\
 b &= \begin{pmatrix} 1 \\ 2 \end{pmatrix}, \begin{pmatrix} -1 \\ -2 \end{pmatrix} \\
 \begin{pmatrix} 1 & 2 \\ 4 & 3 \end{pmatrix} b &= \begin{pmatrix} -1 & 0 \\ 0 & -1 \end{pmatrix} b \\
 \begin{pmatrix} 2 & 2 \\ 4 & 4 \end{pmatrix} b &= 0 \\
 b &= \begin{pmatrix} 1 \\ -1 \end{pmatrix}, \begin{pmatrix} -1 \\ 1 \end{pmatrix}
 \end{aligned}$$

4b.

Figure 4. The course manual dealing with the two processes and Student 6’s solution to the problem.

The transformation of this equation to the form  $(A - \lambda I)x = 0$  in order to carry out the process to find the eigenvalue  $\lambda$  tends not to make explicit the change from  $\lambda$  to  $\lambda I$ , from a scalar to a matrix. The section of the course manual where this is done is shown in Figure 4a. We see that the problem is skated over and the comment is simply made “note the use of  $I$  here.” In Figure 4b we see the example of student 6 who explicitly replaces the 5 and  $-1$  in  $5b$  and  $-1b$  on the right of the equation with the matrices  $5I$  and  $-I$ . This no doubt helped him with equating the objects of the processes, but thinking of  $Ax = \lambda x$  as  $Ax = \begin{pmatrix} \lambda & 0 \\ 0 & \lambda \end{pmatrix} x$  may be an obstacle to understanding how the definition of an eigenvector relates to the algebraic representation.

**Symbolic manipulation action-process problems**

Of the ten students we considered in detail, 5 were able to find correctly both the eigenvalues and eigenvectors for the matrix  $A = \begin{pmatrix} 1 & 2 \\ 4 & 3 \end{pmatrix}$  in question 2. Of the others, two (students 2 and 9) found the eigenvalues but were unable to find the corresponding eigenvectors, and three (students 1, 3 and 10) were unable to make any progress. Student 3 wrote “I just forgot conseption [sic] of it” and student 10 “I would like to do this with the help of Maple.”

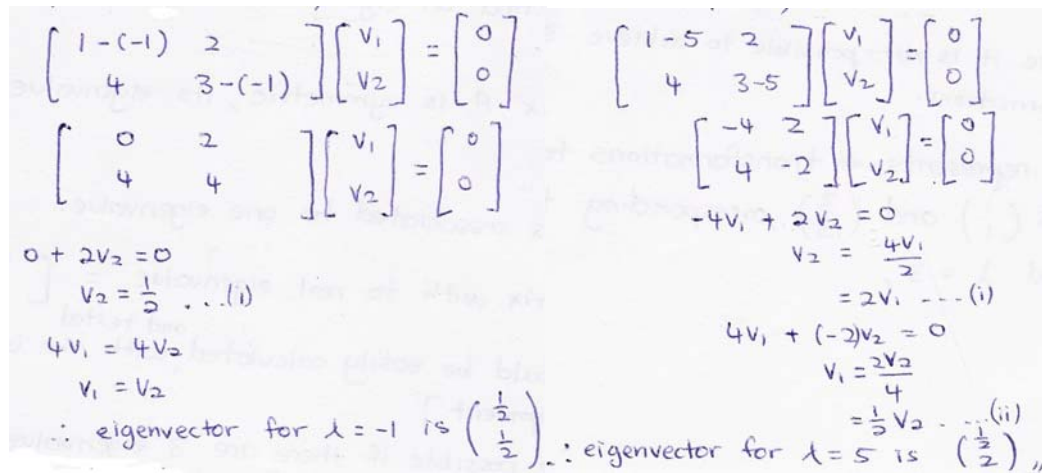

Figure 6. Student 9’s working to find the eigenvectors.

Student 9’s working as she tries to find the eigenvectors is shown in Figure 6. The arithmetic and symbolic manipulation here contains a number of errors ( $1 - (-1) = 0$ ;  $0 + 2v_2 = 0 \Rightarrow v_2 = 1/2$ ;  $4v_1 + 4v_2 = 0 \Rightarrow 4v_1 = -4v_2$ ; and  $v_2 = 2v_1 \Rightarrow$  eigenvector is  $(0.5, 2)$ ), showing a weakness in such manipulation, rather than in the understanding of the conceptual process. Student 2 made a similar manipulation error, moving from writing the matrix  $\begin{pmatrix} -4 & 2 \\ 4 & -2 \end{pmatrix}$ , without a vector, say,  $\begin{pmatrix} v_1 \\ v_2 \end{pmatrix}$ , or an ‘=0’, to an incorrect vector  $\begin{pmatrix} 2 \\ -1 \end{pmatrix}$ .

$$\begin{pmatrix} 1 - 5 & 2 \\ 4 & 3 - 5 \end{pmatrix} \begin{pmatrix} v_1 \\ v_2 \end{pmatrix} = \begin{pmatrix} 0 \\ 0 \end{pmatrix}.$$

$$\begin{pmatrix} -4 & 2 \\ 4 & -2 \end{pmatrix} \begin{pmatrix} v_1 \\ v_2 \end{pmatrix} = \begin{pmatrix} 0 \\ 0 \end{pmatrix}.$$

One non-zero solution to this system is  $\begin{pmatrix} 1 \\ 2 \end{pmatrix}$ .

Figure 7. Part of the course manual’s method for finding an eigenvector.

The fact that the working in the final stages of the process of finding the eigenvector caused some problems is not surprising when we look at the course manual. We can see from Figure 7 that the final steps in the method are not delineated, but are presumably left for the student to complete. As we can see, they sometimes find this

a problem. This omission proves, we think, to be even more costly in terms of conceptual understanding, as we explain below.

### Conceptual object problems

Questions 4 and 8 in the test addressed the conceptual nature of the eigenvector by considering two of its properties. A student with an object perspective of eigenvector might be expected to describe whether a vector is an eigenvector or not, without resorting to a procedural calculation (Q4), and to say that any scalar multiple of the eigenvector will also be an eigenvector (Q8). Students 2, 4, 5, 6, 7, and 8 correctly found the eigenvectors from the procedure. Of these three gave a procedural response to question 4, referring to key aspects in the symbolic world, rather than giving an object-oriented answer.

Student 5: First let the matrix times the vector...If the answer equal to  $\begin{pmatrix} v_1 \\ v_2 \end{pmatrix}$  or n times

$\begin{pmatrix} v_1 \\ v_2 \end{pmatrix}$  then  $\begin{pmatrix} v_1 \\ v_2 \end{pmatrix}$  is an eigen vector of the matrix.

Student 6: Using the equation  $Ab=\lambda b$  to confirm the relation.

Student 7: Use the formular [sic]  $Av=\lambda v$ .

In contrast, the others gave replies based on the word definition, showing some move away from the need to employ the symbolic world towards properties of a formal object:

Student 4: When a given vector multiply with a matrix, if the direction of the vector doesn't change, only expanded or shrinked we can say the given vector is the eigenvector.

Student 8: When its direction isn't changed when it's multiplied by the matrix.

In their responses to question 8, students 1, 2, 4, 5, and 9 stated that there is only one eigenvector associated with each eigenvalue. Stating, for example, "Each instance of an eigenvalue has one and only one eigenvector associated with it." (student 2) and "One eigenvector is associated to one eigenvalue." (student 9). However, students 3 and 7 said that there were an infinite number, writing "I think that for any eigenvalue can be infinitely [sic] number of eigenvector because [blank]." (4) and "infinity" (7).

As mentioned above (see Figure 7) the course manual did not put in all the details at the end of the method to find the eigenvector. As we see in Figure 8, 2 students (2 and 6,) followed this pattern and tried to write down the vectors from the matrix form of  $(A - \lambda I)x = 0$ , one succeeding (6) and the other not (2). Others (students 7, 8), went further, and were sometimes unsuccessful due to manipulation errors (7, 9—see Figure 6), or managed it correctly (5, 8). In the case of student 5 this was accomplished using  $v_1$  and  $v_2$ , but giving them the values 1 and 2 at a crucial point. However, only one student (4) managed to write the eigenvectors in the form  $\begin{pmatrix} v_1 \\ 2v_1 \end{pmatrix} = v_1 \begin{pmatrix} 1 \\ 2 \end{pmatrix}$  and  $\begin{pmatrix} v_1 \\ -v_1 \end{pmatrix} = v_1 \begin{pmatrix} 1 \\ -1 \end{pmatrix}$  before getting the eigenvectors correct. Unfortunately,

this student was not among only two who were able to say that there are an infinite number of possible eigenvectors. This step of seeing that any scalar multiple  $v_1$  of the vector satisfies the equation may be a direct consequence of understanding this last step in the symbolic world manipulation, missing from the manual.

## CONCLUSION

This study suggests that the students who received encouragement to think in an embodied way about eigenvectors found it a useful adjunct to the procedural calculations they carried out in the symbolic world. It seems that these manipulations in the matrix and algebraic domains caused some conflict with understanding the natural language definition of eigenvalues and eigenvectors, and that an embodied approach may mediate initial understanding. We have seen the importance of presenting complete procedures for finding eigenvectors, and of linking these to conceptual ideas such as the number of possible eigenvectors. The two different processes in  $Ax = \lambda x$  may be preventing understanding of key ideas and the role of this obstacle requires further investigation. When asked whether they thought computers should be used in linear algebra lectures the majority of students agreed that such work was beneficial, and this may provide a way forward.

## References

- Cottrill, J., Dubinsky, E., Nichols, D., Schwingendorf, K., Thomas, K. & Vidakovic, D. (1996). Understanding the limit concept: Beginning with a coordinated process scheme. *Journal of Mathematical Behavior*, 15, 167–192.
- Dubinsky, E. & McDonald, M. (2001). APOS: A constructivist theory of learning. In D. Holton (Ed.) *The Teaching and Learning of Mathematics at University Level: An ICMI Study* (pp. 275–282). Dordrecht: Kluwer Academic Publishers.
- Greer, B. & Harel, G. (1998). The role of isomorphisms in mathematical cognition. *Journal of Mathematical Behavior*, 17(1), 5–24.
- Klapsinou, A. & Gray, E. (1999). The intricate balance between abstract and concrete in linear algebra. In O. Zaslavsky (Ed.), *Proceedings of the 23<sup>rd</sup> conference of the International Group for the Psychology of Mathematics Education* (Vol. 3, pp. 153-160). Haifa, Israel: Program Committee.
- Tall, D. O. (2004a). Building theories: The three worlds of mathematics. *For the Learning of Mathematics*, 24(1), 29–32.
- Tall, D. O. (2004b). Thinking through three worlds of mathematics. *Proceedings of the 28<sup>th</sup> Conference of the International Group for the Psychology of Mathematics*, Bergen, Norway, 4, 281–288.
- Thomas, M. O. J. (in print). Conceptual representations and versatile mathematical thinking. *Proceedings of ICMI-10*, Copenhagen, Denmark.
- Thomas, M. O. J. & Hong, Y. Y. (2001) Representations as conceptual tools: Process and structural perspectives. *Proceedings of the 25<sup>th</sup> Conference of the International Group for the Psychology of Mathematics Education*, Utrecht, The Netherlands, 4, 257–264.



# CONCEPTUAL CHANGE AS DIALECTICAL TRANSFORMATION

Nadia Stoyanova Kennedy

Montclair State University

*This report concerns an inquiry into the nature and character of conceptual transformation through a process of argumentation in a community of mathematical inquiry. Its theoretical approach is based on Vygotsky's theory of social cognition, which in turn is grounded in the broader framework of Hegelian and Marxist dialectical theories, and systems theory. The study explores mechanisms of conceptual transformation in a dialogical group setting with 21 fifth grade students in a community of mathematical inquiry format. It concludes that the process follows a dialectical model, which the author illustrates through an analysis of group discussions of the concept of infinity.*

## INTRODUCTION

Considerable attention has been given recently to what is referred to as the “conceptual change approach” in mathematics teaching and learning. The discourse of conceptual change was brought to science education via the philosophy and history of science by Posner, Strike, Hewson, & Gertzog (1982) who posited that the patterns and dynamics of students’ conceptual change in the learning of science parallel those found in the history of science, given that scientific change is conceived of as the result of a major paradigm shift or “revolution” whereby a new paradigm replaces an older one, with which it is incommensurable. Posner et al’s (1982) model of students’ conceptual change in science education integrates Kuhn’s (Kuhn, 1970) notion with Piaget’s claim that the reconstruction of cognitive schemas operates through a mechanism of assimilation and accommodation of novel elements or data, thus mirroring Kuhn’s “scientific revolution.”

Whatever the status of the isomorphism between historical and individual development in mathematics, a dialectical model of the transformation of students’ concepts offers a compelling descriptor for the mechanisms which underline conceptual change in mathematical learning, given that it emphasizes the extent to which students’ current conceptions, no matter how originally naïve, develop through a process of continual conflict and its resolution, which operates both on the individual and the social level, and to which notions of dialogue and continual reconstruction are essential for understanding.

Dialectical theory understands knowledge formation as an active, complex, ongoing process of organizing and reorganizing conceptual structures rather than as accumulation of fixed truths. Furthermore, it assumes the central role of contradiction in the process of change and reorganization that it presumes to explain. Whether in the field of cognitive development or in the broader realm of psychology, a dialectical view also assumes that developmental processes are socially and culturally

shaped and defined, and that concepts and meanings—whether mathematical or other kinds of meanings—evolve in an emergent process of what Vygotsky (1978), and Leontiev (1981) called a “collective activity system.” The latter is understood to operate through the emergence of cognitive conflict within the conceptual system, leading to the ongoing resolution of that conflict in a dialectical manner—which is to say through the recognition and articulation of contradictions and inconsistencies, and their mediation in the context of a collective activity.

The teleology of the processes of cognitive structural development as defined by the major Western theorist of cognitive change, Piaget, is understood not only as a continuous movement from “nonbalance” towards reequilibration, but as progressively directed towards “increasing equilibrations,” which necessarily require a correspondingly higher cognitive structural organization. Although it was never affirmed by Piaget, several theorists (e.g. Kitchener, 1986) understand his psychological theory of cognitive development to be fundamentally dialectical. And we can identify many parallels between Piaget and the other major theorist of the twentieth century, Vygotsky, at least on the level of the basic, conceptual mechanisms of cognitive development. Vygotsky was in fact an avowed dialectician, who clearly saw cognitive development as “...a dialectical process, a process in which the transition from one stage to the next occurs not through evolution, but through revolution” (Vygotsky, [The problem of age], cited in El’konin, 1977, p. 542). Vygotsky’s application of the dialectical method and the laws of materialist dialectics are most fully apparent in his reliance on the law of the dialectical transformation of quantity into quality, whereby the form that bears that new quality conforms to new laws that formerly went unrecognized. Thus, a similar dialectical reading of systemic change can be found both in the Piagetian and the Vygotskian models of cognitive structural development. Both theories play a major role in the design and interpretative structure of this study.

## **RESEARCH METHODOLOGY**

The research study here described was conducted in a self-contained fifth grade classroom in a suburban public elementary school in northern New Jersey. The 21 students involved in this project were 10 and 11 years old. The study was intended as primarily qualitative and naturalistic in nature. More specifically, I adopted a “grounded theory” approach (Glaser & Strauss, 1967) in order to analyze the process of mathematical concept transformation, and how it evolves in and through argumentation. From the point of view of the interpretation of data, the study adopted a dialectical perspective in analyzing the transformation of students’ conceptual development. As such, the unit of analysis was defined as the complex system of the whole group. In framing my unit of analysis as the group of subjects which comprise a collective system, I sought to address, not only the role of the activities the group engaged in as a tool for mediating students’ cognitive processes, and not just the effects of the social variables involved in students’ conceptual development, but also the mechanisms through which the various relationships between elements of the

group system—whether cognitive, psychodynamic, sociodynamic or discursive—contributed to the observed developmental outcome. In short, my goal was to portray a system in transformation.

My research question was concerned with processes of cognitive transformation in a community of mathematical inquiry. The latter, understood as a systemic phenomenon, requires research methods and instruments capable of capturing, not just the initial and final products, but the process as a whole. Most of the discussions were structured around “paradoxical problems,” whose common characteristic is that they offer a strong element of cognitive surprise and, given their succinctness, a well-defined starting point for discussion. The overarching objective was that each problem would be resolved in a context of communal dialogical inquiry, i.e. in a discursive format in which participants were expected to justify their ideas or procedural moves to and with each other. A problem was presented (e.g. Cantor’s paradox) at the beginning of each session and the discussion began immediately; thus the agenda for each session was spontaneous, emergent, and guided both by the group and the facilitator.

Four consecutive transcripts—taken from a total of 19 audio and videotapes—of conversations about the concept of infinity were chosen, because they reflected a progressive sequence in which greater depth, complexity and clarity of thinking about the concept emerged over the course of the discussions. The categories developed through an open coding of the first transcript yielded a picture of the developmental process of conceptual transformation as progressing from a phase of 1) elicitation of students’ spontaneous conceptions, to 2) a building phase, to 3) a phase of conflict, and finally, 4) a phase of synthesis-consolidation of the concept. These categories were further “saturated” by searching through the other three transcripts in the sequence—that is, by looking for instances representing the respective phases. The dynamic relation between the four phases was examined in order to construct a dialogical and a dialectical model of conceptual transformation.

## **ANALYSIS**

This report will be restricted to the initial discussion about finite and infinite, where the class was presented with simple definitions of infinite and finite collections (or sets), without further explanation or exemplification. The task in this first session was presented to the group as a discussion of finite and infinite, and an assay at collective thinking about them through some examples. The facilitator had a broader, tacit goal of identifying some specific attributes of these concepts that might facilitate further, more sophisticated work with them. The following discussion can be approached at three levels or dimensions of analysis—phenomenological, analysis in terms of the structure and development of the activity, and dialectical—and although their separation is artificial, distinguishing them at least temporarily will contribute in the long run to a more integrated understanding of what goes on in this kind of conversation.

## Phenomenological Analysis

The transcript which follows began with these questions: Do you think that your class is finite or infinite? And how about a galaxy?

Facilitator: Today we'll start with some examples of finite and infinite groups or what mathematicians call sets. Let's think your class. Do you think it's a finite or infinite group or set?

Bill: Finite.

Facilitator: Why?

Bill: Because there are a certain number of kids.

Facilitator: Yes, we have a certain number of students or as a mathematician would say it in mathematical language, "elements." How about a galaxy? What are the elements?

Voices: Stars.

Facilitator: Do you think it's a finite or infinite set?

Bud: I think it's finite, because when some stars die—like a supernova—they're not stars anymore.

Facilitator: Do you agree with this argument that some stars are dying and therefore a galaxy would be a finite set?

Samantha: Well, some stars are dying, but other stars are born.

Facilitator: So, what can we conclude?

Victor: I disagree with Ben, because though something is dying, more are born. So it's infinite.

Facilitator: So you're saying that there are infinitely many stars in a galaxy? We might consider two things here. First: the number of the elements—whether they're finite or infinite, and second, we can think whether the set is bounded or unbounded. What do you think?

Chas: I just know that a galaxy isn't infinite. So I'm going to say the other thing, because there is more than one galaxy in our universe. Because if it was infinite it would go on and on, and our galaxy isn't infinite. The galaxy is bounded, it has to stop. Then it goes to another galaxy and into another galaxy.

In this initial round of the generation of ideas, some precisening of concepts had already started to take place, as indicated by the recognition of a few attributes of the concepts which had been offered. The facilitator then suggested another conceptual tool that she thought might be useful in the joint activity of making distinctions: the auxiliary concept of a collection [set] as being either "bounded" or "unbounded," a concept which was grasped intuitively by the students. In this particular case, several students used this binary concept to make further distinctions among several possibilities which had already emerged, i.e. bounded sets with finite or infinite elements, and bounded sets with finite or infinite elements.

Chas, for example, gave an example of a distinction between bounded and unbounded galaxies whose elements might be finite or infinite. A distinction was also made between the physical boundaries of a set and its elements. This distinction was advanced further by Bill and Jimmy, although they didn't appear to be in agreement. Shortly thereafter, Sally and Rush shared the idea that a single galaxy is bounded, but that the whole universe is unbounded. At this point Rush seemed to be assuming that the number of stars is infinite, because we can't count them, since they change all the time.

Bill: I say that a galaxy is infinite, the actual galaxy, but the actual content is finite.

Facilitator: So you're saying that a galaxy isn't bounded, but there are finite stars or elements which are finite. Do you agree with that?

Jimmy: I don't. I don't think a galaxy is unbounded. Really, there must be something like another galaxy out there. Some galaxies also are expanding, but they go and stop.

Facilitator: So, you think that a galaxy is bounded, and also there are finite elements/stars inside it.

Jimmy: Finite means what?

Facilitator: Finite means a certain number of stars.

Jimmy: O.K. No, I don't think that the stars can be really counted.

Facilitator: You're saying that a galaxy can be bounded, and can contain infinite number of stars. O.K. This is a different point.

Rush: I think a galaxy isn't bounded and keeps going on and on.

Sandra: Do you mean there is only one galaxy going for ever?

Rush: No, I mean all the galaxies together are not bounded, but each one ends somewhere. But we can't count the stars, they change all the time.

Facilitator: O.K. So you're saying that a galaxy is bounded but we can't count the stars.

Sally: I think there are different galaxies, but it goes on forever.

Facilitator: Are you talking about the universe?

Sally: Yes, I think one galaxy is bounded, but the universe is unbounded.

Facilitator: O.K. Let's move to another example. How about a forest? Let's think about the trees in a forest. Is a forest bounded? Are the trees in a forest finite or infinite in number?

Samantha: It's finite, because trees are dying and it...hmm...

Sally: It's bounded.

Sandra: What about the elements, the trees? Are they infinite or finite?

Sally: I don't think we can count the trees in a forest. One day they're one number, but what if the next day some trees die?

Chas: I pretty much agree with it. The forest isn't infinite at least in this world and we all know that. They...unless you're a dummy, you couldn't say that the ocean is forest. ...So, I think the forest is bounded, whereas the things in it are infinite.

Here the students appeared to be more confident with the terminology involved, and began incorporating new terms into their questions and explanations. But again there was an apparent misconception, in that what appeared to be understood as the impossibility of counting "the elements" was also understood as infinitude. Looking for opportunities to confront this, the facilitator began asking the students to give their own examples of finite/infinite.

Darlene: The earth and the humans on it. The earth is bounded, but the humans are infinite.

But is the number of the humans on the earth really an infinite one? Here the inquiry seemed to have stumbled upon the same problem encountered in the example above. Does the impossibility of counting the elements of a set define an infinite set? Does the permanent changeability of a number imply infinitude? At first it seemed that the practical impossibility—or rather the extreme difficulty—of counting all the people on the earth was assumed to imply that there is an infinite number of people on the earth; but when the discussion focused on that implication, the idea was scrutinized and verbalized more precisely.

Bill: Well, the number increases or decreases all the time.

Facilitator: Oh, you're saying that this number changes. But, do you think that if you have the techniques to count one day all the humans on the earth, we'll get a number?

Nellie: I don't think it's possible, because you have to go around the world and count all people and people are born all the time and you have to go back and forth. So it isn't possible.

Sandra: But we do have a number for the human population given in the books.

Sandra's question confronted the idea of the impossibility of all people being counted by introducing a putative fact—based on an argument from authority—as a counterexample. The confrontation between a spontaneous and scientific notion tends to induce another way of thinking, and in fact resulted in the change of the previous idea into a new one: that in fact one cannot say that the number of people on the earth is infinite, but only that it is so difficult to get the exact number that the total number will always be an approximation.

Victor: This number might be close to the right number, but not the right number, 'cause the number of the people changes so fast.

Facilitator: O.K. We're saying that it's very difficult to get the exact number of people that live on the earth, and we always have a number which is an approximation, because the growth of the population is fast. But does it mean that we have infinite people on the earth?

Chas: No, there is always a certain number, which means a finite number. We can't count it. It can't really happen.

This session can be read as a sign of the beginning of those processes of differentiation which are considered to be a necessary part of the larger process of ongoing conceptual reconstruction. Many recognitions of details and of finer distinctions within the concept were brought to the discussion—for example characteristics of the physical boundaries of a set and its elements, as well as the possibility that a set might be bounded and unbounded, with elements which in turn might be finite or infinite. Some of these new distinctions were probably made possible by the introduction of this new conceptual tool—the auxiliary conceptions of “bounded” and “unbounded”—in the beginning of the discussion. Even this early in the conversation, some modifications in the students’ spontaneous conceptions were noticeable—for example, the misconception that an infinite set is one which has elements which cannot be counted because they fluctuate or change all the time was evaluated, then modified by the group.

### Activity Structure and Development

As the collective activity evolved through reflection on examples, and as the students’ notions about finite and infinite became more complex, a contradiction was generated, and it slowly precipitated until it emerged on the surface of the discussion. The glaring confrontation of the two notions discussed above concerning the countability of living humans led to the mutual reformulation of the goal of the activity as resolving this conflict. This new goal represents a loop in the activity—a loop whose starting point was the full emergence of the contradiction, and which ended with its resolution. The activity then transitioned back to the exploration of examples—i.e. continued with the original activity and resumed working towards the original goal. On the basis of this analysis, it is possible to construct a schema which at least partially captures the evolution of this—and, I will argue, other—goal-oriented activities like this one. Briefly described, the original activity leads to the emergence of some contradictions (cognitive conflicts), which force the collective activity to redirect to a different but related sub-goal of resolving the conflicts. Once the conflict is solved, the activity resumes its course.

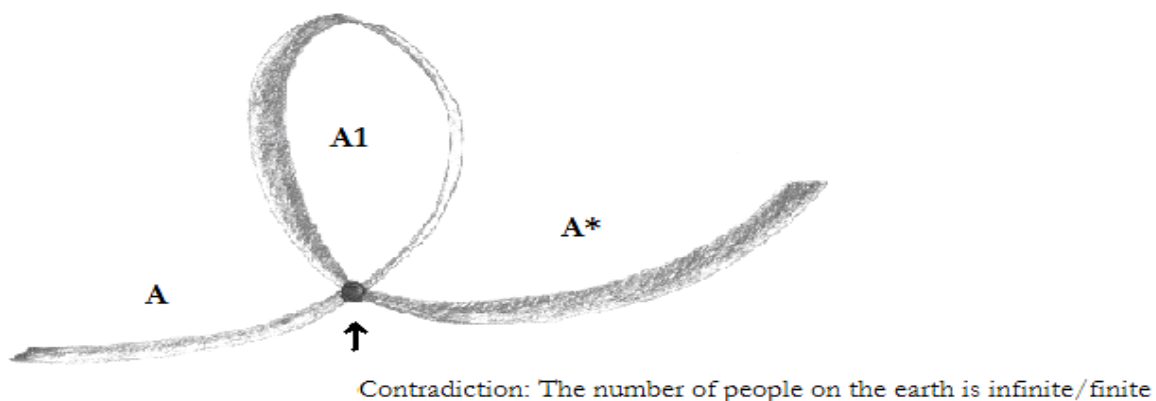

A: Discussion of the finite and the infinite: exploring examples

A1: Discussion of the number of people on the earth

A\*: Return to discussion A

A (activity) – GA (goal) – A1 – G1 – A\* – GA

Figure 1: Activity trajectory

## Brief Summary

In the discussions about infinity the **orientation phase** (described above) was planned by the facilitator to elicit and question students' spontaneous conceptions of finite and infinite. In this case the orientation phase allowed for some opposition between students' spontaneous conceptions and reality to emerge, enter into conflict, and be resolved. Hence, in what was planned as an orientation we see a whole dialectical mini-circle completed.

During the **building phase**, students started to verbalize their statements as possible solutions to the learning task. I call it a building phase because sometimes the clear meaning of students' statements takes time to be articulated, and requires feedback from the community to be formulated—hence the arguments and the structure of argument which they form “build” slowly through a collaborative work. During this phase both the thesis and the antithesis are presented, but it might take additional time for them to be recognized as opposites. In the **conflict phase**, the key assertions are sorted out. Here the opposition presents itself in full, and forces the inquirers to focus on this contradiction (inadequacy)—to be consciously aware of it and to search for a resolution. And in the last or **synthesis phase**, a resolution is found which closes the cycle figuratively where it began, but with a new conceptual formation which is enriched and more sophisticated.

All this indicates the presence of patterns of conceptual change that confirm Vygotsky's notion of the dialectical interactions between spontaneous and scientific concepts in a learning situation. It suggests a dialectical model of conceptual transformation in mathematical learning, one which is, however, fully dependent—not just for its development, but for the very possibility of its implementation in mathematics education—on the structure and function of community of inquiry, i.e. A dialogical, emergent, democratic, self-organizing form of classroom discourse.

## References

- El'konin, D. (1977). Towards the problem of stages in the mental development of the child. In M. Cole (Ed.), *Soviet developmental psychology* (pp. 539-563). New York: Sharpe.
- Glaser, B., & Strauss, A. (1967). *The discovery of grounded theory*. Chicago: Aldine.
- Kitchener, R. (1986). *Piaget's theory of knowledge: Genetic epistemology & scientific reason*. New Haven, MA: Yale University Press.
- Kuhn, T. (1970). *The structure of scientific revolutions*. Chicago, IL: Chicago Press.
- Leontiev, A. (1981). *Problems of the development of the mind*. Moscow: Progress.
- Posner, G. J., Strike, K. A., Newson, P. W., & Gertzog, W. A. (1982). Accomodation of a scientific conception: towards a theory of conceptual change. *Science Education*, 66(2), 211-227.
- Vygotsky, L. (1978). *Mind in society: The development of higher psychological processes*. Cambridge, MA: Harvard University Press.



# CONTENT KNOWLEDGE FOR MATHEMATICS TEACHING: THE CASE OF REASONING AND PROVING<sup>1</sup>

Andreas J. Stylianides

University of California-Berkeley

Gabriel J. Stylianides

University of Pittsburgh

*In this paper, we discuss issues of content knowledge that is important for mathematics teaching. Specifically, we present a framework for the content knowledge of “reasoning and proving” that is important for teaching elementary school mathematics, and we consider how this knowledge can be effectively promoted in mathematics courses for preservice elementary school teachers. We argue that these courses need to place emphasis on the use of a special category of tasks that we call “teaching-related mathematics tasks.” These are mathematics tasks that are connected to teaching, and have a dual purpose: (1) to foster teacher learning of mathematics that is important for teaching, and (2) to help teachers see how this mathematics relates to teaching. We discuss and illustrate the nature of these tasks.*

Over the past two decades an extensive body of research has focused on teachers’ *content knowledge* (Shulman, 1986), studying its relationship with effective teaching. It is now well documented in the literature that teachers’ ability to teach mathematics depends on their mathematics content knowledge (e.g., Ma, 1999). Nevertheless, it is still unclear what teachers need to know about each mathematical topic or activity they teach (Ball et al., 2001), and also how this knowledge can be effectively promoted in mathematics teacher preparation programs. In this paper, we take a step toward addressing this problem, focusing on the activity of **reasoning and proving (RP)**. Specifically, we: (1) present a framework for the content knowledge of RP that is important for elementary mathematics teaching; and (2) consider how this knowledge can be effectively promoted in mathematics courses for preservice elementary school teachers, focusing on the nature of tasks used in these courses.

## BACKGROUND

As background for the paper, we (1) elaborate on the importance of teachers’ content knowledge of RP, (2) present our conceptualization of RP, and (3) examine an episode from third grade to illustrate what RP might look like at the elementary school (grades K through 6) and to see what is important for elementary school teachers to know about RP in order to cultivate this activity in their classrooms.

## Importance of teachers’ content knowledge of reasoning and proving

There is growing appreciation of the idea that doing and knowing mathematics is a *sense-making activity*, that is, activity characterized by meaningful learning. There is also appreciation of the intimate relation between sense making and the activity

---

<sup>1</sup> The two authors had an equal contribution in writing this paper. We wish to thank Alan Schoenfeld for his useful comments on an earlier version of the paper.

2006. In Novotná, J., Moraová, H., Krátká, M. & Stehlíková, N. (Eds.). *Proceedings 30<sup>th</sup> Conference of the International Group for the Psychology of Mathematics Education*, Vol. 5, pp. 201-208. Prague: PME. 5 - 201

of *RP*: a typical structure of students' engagement in sense making is to first explore mathematical phenomena to identify patterns and make conjectures, and then investigate with arguments and proofs the truth of the conjectures to establish new knowledge (Boero et al., 1996; Mason et al., 1982; NCTM, 2000; Schoenfeld, 1983). Because students' engagement in mathematics as a sense-making activity is a high-priority goal of school instruction, and because of the intimate relation between sense making and *RP*, many researchers and curriculum frameworks (especially in the USA) recommend that *RP* become central to *all* students' mathematical experiences across *all* grades (e.g., Ball & Bass, 2003; NCTM, 2000; Yackel & Hanna, 2003).

Yet, research shows that students of all levels face serious difficulties acquiring competency in *RP* (e.g., Healy & Hoyles, 2000; Reiss et al., 2002). Research shows also that teachers, especially elementary teachers, have weak content knowledge of *RP* (e.g., Martin & Harel, 1989; Simon & Blume, 1996), and that textbooks used in mathematics courses for preservice teachers do not systematically support rich opportunities for teacher learning of *RP* (McCrory et al., 2004). This situation is problematic: teachers' ability to teach is a function of their content knowledge, so if teachers do not develop deep and robust content knowledge of *RP*, we cannot expect that they will be able to effectively promote *RP* in their classrooms.

### **A conceptualization of reasoning and proving in school mathematics**

In school mathematics, the development of *proofs* is often treated as a formal process (in high school geometry), isolated from other mathematical activities. However, this treatment of proof is problematic. The work in which mathematicians themselves engage that culminates in a proof typically involves searching a mathematical phenomenon for *patterns*, making *conjectures* based on the patterns, and providing informal *arguments* demonstrating the viability of the conjectures (Schoenfeld, 1983). These activities aid any doer of mathematics in understanding the phenomenon under examination, building a foundation for the development of proofs (Boero et al., 1996; Mason et al., 1982; G. Stylianides, 2005). Thus, by viewing proof in isolation from the activities that support its development, we do not afford students the same level of scaffolding used by professional users of mathematics to make sense of and establish mathematical truth.

Our conceptualization of *RP* situates the development of proofs in the set of activities involved in making sense of and establishing mathematical truth. Specifically, we use *RP* to describe the overarching activity that encompasses the set of activities associated with identifying *patterns* (general relations that fit given sets of data), making *conjectures* (reasoned hypotheses that are subject to testing), providing *arguments* (connected sequences of assertions) for or against the conjectures, and developing *proofs* (valid arguments from accepted truths that establish the truth or falsity of the conjectures) (G. Stylianides, 2005). This conceptualization of *RP* is not linked to any particular mathematical domain (e.g., geometry) or grade level.

## Reasoning and proving at the elementary school: An episode from third grade

*Episode:* In a third-grade class, students are investigating what happens when they add any two odd numbers. They check several examples, identify the pattern that the sum in all the examined cases is an even number, and formulate – with their teacher’s help – the conjecture that the sum of any two odd numbers is even. The teacher then challenges the students to explain why their conjecture should be accepted. This provokes many different arguments. Jeannie argues that the class cannot prove the conjecture for all pairs of odd numbers, because “odd numbers and even numbers go on for ever and so one cannot prove that all of them work.” But other students disagree with her. For example, Ofala asserts that the conjecture is true because she verified it in 18 particular cases (e.g.,  $1+5=6$ ). The lesson continues with students sharing their thoughts and the teacher pressing students to justify their thinking. The next lesson begins with the teacher reviewing the issue raised by Jeannie about why the class could not prove the conjecture. The teacher explains to the students that mathematicians would address this issue by trying to see what property of odd numbers makes the combination of two of them always an even number. She then helps the students remind themselves of their definitions of even and odd numbers, and challenges them to use these definitions to prove the conjecture. Betsy proposes the following proof for the conjecture: “All odd numbers if you circle them by twos there’s one left over. So, if you add two odd numbers, the two ones left over will group together and will make an even number.” (Ball & Bass, 2003)

What *mathematics* did the teacher in the episode above need to know to effectively manage her students’ engagement in RP? She needed to know at least three things: (1) The important idea that *patterns* can give rise to *conjectures*, which in turn motivate the development of *arguments* that may or may not qualify as *proofs*; (2) How to make sense of and evaluate mathematically different student *arguments*; and (3) The mathematical resources necessary for the development of a *proof* (notably, the *definitions* of even and odd numbers) in order to help her students acquire these resources. Thus, the episode illustrates the complexity and subtlety of the content knowledge of RP that is important for teaching elementary school mathematics, especially as it pertains to engaging students in RP. This raises a critical question: What content knowledge of RP is important for elementary school teachers to know?

### A FRAMEWORK FOR THE CONTENT KNOWLEDGE OF REASONING AND PROVING THAT IS IMPORTANT FOR ELEMENTARY SCHOOL MATHEMATICS TEACHING

Using the findings of classroom-based research on elementary mathematics teaching that aimed to promote RP (Ball & Bass, 2003; A. Stylianides, 2005, in press), we developed a framework for the content knowledge of RP that is important for elementary mathematics teaching. The framework is structured around four ideas. Next we present the four ideas and illustrate them using the episode from third grade.

#### Idea 1: Patterns → Conjectures → Arguments (which may or may not qualify as Proofs)

*Description.* Idea 1 derives directly from our conceptualization of RP and emphasizes the following important *connection* among patterns, conjectures, arguments, and proofs: patterns can give rise to conjectures, which in turn motivate the development of arguments that may or may not qualify as proofs (G. Stylianides, 2005). Teachers

need to know this connection: if they engage their students in the aforementioned sequence of activities, students are likely to share sufficient interest in knowing whether their conjectures are true and to recognize the need for a proof (Balacheff, 1990; Mason et al., 1982). An implication of Idea 1 is that teachers need to be able to distinguish between proofs and arguments that do not qualify as proofs, such as empirical arguments (Martin & Harel, 1989; Simon & Blume, 1996).

*Example.* In the episode, the teacher demonstrated good knowledge of the connection described in Idea 1. She engaged her students in an activity that led to the formulation of a conjecture, which spurred debate over whether and how one could prove it. Thus, the search for a proof arose naturally from students' activity.

### Idea 2: RP is Bounded by the Community's Existing Knowledge

*Description.* Idea 2 denotes that students' engagement in RP is bounded by their existing knowledge (e.g., Ball & Bass, 2003; Simon & Blume, 1996; Yackel & Cobb, 1996). Accordingly, teachers need flexible content knowledge of RP that will allow them to identify mathematical resources that are crucial for students' engagement in RP and organize their instruction accordingly. This flexible knowledge will help teachers make sense of and evaluate different student arguments, thereby supporting instruction that attends seriously to student thinking (Ma, 1999). Furthermore, teachers need to be able to produce multiple legitimate ways to define concepts, prove statements, etc., in order to accommodate the needs, and manage the constraints in the existing knowledge, of different student populations.

*Example.* In the episode, the teacher recognized that knowledge of definitions of even and odd numbers was crucial for the development of a proof for the claim "odd+odd=even" (see Idea 3 for elaboration). For this reason, she focused her students' attention on their definitions of these concepts.

### Idea 3: Mathematical Definitions are Central to RP

*Description.* Idea 3 is that mathematical definitions are central to RP practices, in classrooms. Teachers need to know that definitions help the classroom community develop a shared understanding of mathematical concepts, and that definitions are the basis of arguments and proofs (e.g., Ball & Bass, 2003; Mariotti & Fischbein, 1997; Zaslavsky & Shir, 2005). An implication of Ideas 2 and 3 is that teachers need to develop an understanding of what makes a good definition and also the ability to tailor these definitions to their students' existing knowledge.

*Example.* Building on the example in Idea 2, Betsy's proof in the episode was based on the following definition of odd numbers: "Odd numbers are the numbers that if you group them by twos there is one left over." This definition expresses a property that is true for *all* odd numbers, thus supporting the development of an argument that covers the general case.

### Idea 4: Different Kinds of Tasks Can Offer Different Kinds of Opportunities for RP

*Description.* Idea 4 is that different kinds of tasks can offer students different kinds of opportunities for RP. Specifically, there are two main mathematical characteristics of

the statement in a task that affect the RP activity in which students can engage: (1) whether the statement is *true* or *false*, and (2) whether the statement refers to a *finite* or an *infinite* number of cases (A. Stylianides, 2005). For students to develop an integrated understanding of RP, it is necessary that teachers know how to analyze the opportunities that different tasks can afford so as to implement effectively a balanced representation of different kinds of tasks in their classrooms.

*Example.* In the episode, the statement “odd+odd=even” in the task is *true* and refers to an *infinite* number of cases. Students would get different experiences if they engaged in other kinds of tasks, such as the examination of the statement: “There are exactly 4 different ways for the sum of two dice to be 5.” This is a *true* statement that refers to a *finite* number of cases. Students can prove it by enumerating systematically all possible cases; systematic enumeration of each particular case cannot be used to prove statements that refer to infinitely many cases.

## PROMOTING THE CONTENT KNOWLEDGE FOR MATHEMATICS TEACHING: USING A SPECIAL CATEGORY OF MATHEMATICS TASKS

It is well documented in the literature (e.g., Ball et al., 2001; Ma, 1999) that elementary teachers not only need to know the mathematics they teach (e.g., how to divide fractions), but they also need to know this mathematics in ways that are useful for teaching (e.g., they need to be able to respond to a student who might ask whether the “invert and multiply” procedure for dividing fractions is equivalent to the non-standard procedure of “dividing numerators and denominators”). Thus, it is important that mathematics courses for preservice elementary teachers use mathematics tasks that provide preservice teachers with rich opportunities to learn mathematics in connection with the domain to which this learning will be used, namely, the work of mathematics teaching. Nevertheless, numerous anecdotal reports and some research (McCrary et al., 2004) suggest that existing mathematics courses for preservice teachers tend to use tasks that do not promote learning in the way described above.

An example of a standard mathematics task used in mathematics courses for preservice elementary teachers is the following: “Prove that the sum of two odd numbers is even.” Although this task can promote teacher learning of proof, it is not designed to foster connections between the intended learning and situations in teaching where this learning can be useful. Such connections are crucial because: (1) they can help preservice teachers appreciate the need for the mathematics that teacher educators teach them, and thus, increase the possibility that preservice teachers will learn this mathematics; and (2) they make it more likely that preservice teachers will utilize this learning in their teaching.

We argue that mathematics courses for teachers need to place emphasis on the use of a special category of tasks that we call **teaching-related mathematics tasks**. These are *mathematics* tasks that are *connected to teaching*, and have a dual purpose: (1) to foster teacher learning of mathematics that is important for teaching, and (2) to help teachers see how this mathematics relates to the work of teaching. The *connections to teaching* can take one or both of two forms. Next we outline and exemplify these

## Stylianides & Stylianides

forms by using examples from our mathematics course for preservice elementary teachers. Our course uses heavily teaching-related mathematics tasks.

### Form 1: The task is embedded in a teaching context

For example, in our course for preservice elementary teachers we show the video of the episode described above and we ask our preservice teachers to explain and evaluate mathematically the different student arguments in the clip. This task supports teacher learning related to Ideas 1 and 3 described above.

### Form 2: The task includes reflection of preservice teachers on themselves as teachers of mathematics

For example, after our preservice teachers discuss the different student arguments in the episode described above, we ask them to reflect on whether knowing a single proof for the claim “odd+odd=even” would provide significant leverage for their work in managing classroom situations like the one in the video episode. Our preservice teachers bring up the idea that students who explore relations with these numbers and ultimately engage in the development of a proof for the statement “odd+odd=even” are likely to have significant variations in their existing knowledge, such as in their abilities to use different representations (pictures, algebraic notation, etc.). Thus, teachers need to know multiple ways to prove this statement to be able to evaluate different student arguments and develop a proof at the level of their students. This reflection is the first part of a teaching-related mathematics task that asks preservice teachers to develop, and explain the correspondences among, three different proofs for the statement “odd+odd=even” that may be accessible to different groups of students. This task supports teacher learning related to Idea 2 described above. Figure 1 summarizes our preservice teachers’ work in this task.

<u>Proof using everyday language:</u>	<u>Proof using algebra:</u>	<u>Proof using pictures:</u>
Odd numbers are the numbers that if you group them by twos, there's one left over.	Odd numbers are the numbers of the form $2n + 1$ , where $n$ is an integer.	Odd numbers are of the form: 
Even numbers are the numbers that if you group them by twos, there's none left over.	Even numbers are the numbers of the form $2n$ , where $n$ is an integer.	Even numbers are of the form: 
If you add two odd numbers, the two ones that are left over will make another group of two.	If you add two odd numbers, you get: $(2k + 1) + (2m + 1) = (2k + 2m) + (1 + 1)$ $= 2 \cdot (k + m + 1)$	
The resulting number can be grouped by twos with none left over and, thus, is an even number.	The resulting number is of the form $2n$ and, thus, is an even number.	

Figure 1. Three proofs for the statement “odd+odd=even” and their correspondences.

The examples presented above illustrate how we transformed the standard mathematics task “Prove that the sum of two odd numbers is even” to teaching-related mathematics tasks that support teacher learning related to Ideas 1, 2, and 3. In working on these tasks, our preservice teachers engaged meaningfully with important mathematical ideas in connection with their future work, and they appeared to

appreciate the value of what they were learning. The latter is encouraging, especially in the context of RP, for teachers tend to consider RP as an advanced topic (Knuth, 2002) and, thus, they are often resistant to engage in activities that aim to foster the development of their generally weak content knowledge in this area.

## CONTRIBUTIONS TO THEORY AND PRACTICE

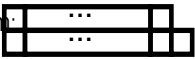
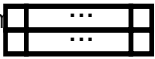
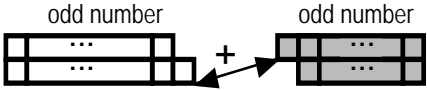
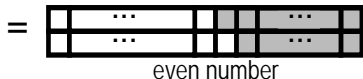
This paper offers insights into the often-problematic relationship between theory on teachers' knowledge and the practical work of mathematics teaching. Specifically, it contributes to teacher educators' understanding of how theoretical ideas on the mathematics content knowledge that is important for teaching can be used to design useful tasks that offer preservice teachers rich opportunities to learn mathematics in connection with the work of teaching. The reflective account of our own personal experiences in designing and implementing teaching-related mathematics tasks illuminates aspects of their role and nature, and suggests their promise for mathematics teacher education. Research is needed to develop a comprehensive set of teaching-related mathematics tasks and explore further their effectiveness through design of experimental or quasi-experimental studies that will examine the implementation of these tasks in mathematics teacher preparation programs.

## References

- Balacheff, N. (1990). Towards a *problématique* for research on mathematics teaching. *Journal for Research in Mathematics Education*, 21(4), 258-272.
- Ball, D. L., & Bass, H. (2003). Making mathematics reasonable in school. In J. Kilpatrick, W. G. Martin, & D. Schifter (Eds.), *A research companion to Principles and Standards for School Mathematics* (pp. 27-44). Reston, VA: National Council of Teachers of Mathematics.
- Ball, D. L., Lubienski, S., & Mewborn, D. (2001). Research on teaching mathematics: The unsolved problem of teachers' mathematical knowledge. In V. Richardson (Ed.), *Handbook of research on teaching* (4th ed., pp. 433-456). New York, NY: Macmillan.
- Boero, P., Garuti, R., Lemut, E., & Mariotti, M. A. (1996). Challenging the traditional school approach to theorems: a hypothesis about the cognitive unity of theorems. In L. Puig & A. Gutiérrez (Eds.), *Proceedings of the 20th Conference of the International Group for the Psychology of Mathematics Education* (Vol. 2, pp. 113-120). Valencia, Spain.
- Healy, L., & Hoyles, C. (2000). Proof conceptions in algebra. *Journal for Research in Mathematics Education*, 31(4), 396-428.
- Knuth, E. J. (2002). Secondary school mathematics teachers' conceptions of proof. *Journal for Research in Mathematics Education*, 33(5), 379-405.
- Ma, L. (1999). *Knowing and teaching elementary mathematics*. Mahwah, NJ: Lawrence Erlbaum.
- Mariotti, M. A., & Fischbein, E. (1997). Defining in classroom activities. *Educational Studies in Mathematics*, 34, 219-248.
- Martin, W. G., & Harel, G. (1989). Proof frames of preservice elementary teachers. *Journal for Research in Mathematics Education*, 20, 41-51.

## *Stylianides & Stylianides*

- Mason, J., Burton, L., & Stacey, K. (1982). *Thinking mathematically*. London: Addison-Wesley.
- McCorry, R., Siedel, H., & Stylianides, A. J. (2004). Mathematics textbooks for prospective elementary and middle school teachers. *Symposium in the Research Pre-session of the Annual Meeting of the National Council of Teachers of Mathematics*. Philadelphia, PA.
- National Council of Teachers of Mathematics. (2000). *Principles and standards for school mathematics*. Reston, VA: National Council of Teachers of Mathematics.
- Reiss, K., Hellmich, F., & Reiss, M. (2002). Reasoning and proof in geometry: Prerequisites of knowledge acquisition in secondary school students. In A. D. Cockburn & E. Nardi (Eds.), *Proceedings of the 26th Conference of the International Group for the Psychology of Mathematics Education, Volume 4* (pp. 113-120). Norwich, Great Britain: University.
- Schoenfeld, A. H. (1983). Problem solving in the mathematics curriculum: A report, recommendations, and an annotated bibliography. *The Mathematical Association of America, MAA Notes, No. 1*.
- Shulman, L. S. (1986). Those who understand: Knowledge growth in teaching. *Educational Researcher, 15*(2), 4-14.
- Simon, M. A., & Blume, G. W. (1996). Justification in the mathematics classroom: A study of prospective elementary teachers. *Journal of Mathematical Behavior, 15*, 3-31.
- Stylianides, A. J. (2005). *Proof and proving in school mathematics instruction: Making the elementary grades part of the equation*. Unpublished doctoral dissertation, University of Michigan, Ann Arbor.
- Stylianides, A. J. (in press). Proof and proving in school mathematics. *Journal for Research in Mathematics Education*.
- Stylianides, G. J. (2005). *Investigating students' opportunities to develop proficiency in reasoning and proving: A curricular perspective*. Unpublished doctoral dissertation, University of Michigan, Ann Arbor.
- Yackel, E., & Cobb, P. (1996). Sociomathematical norms, argumentation, and autonomy in mathematics. *Journal for Research in Mathematics Education, 27*, 458-477.
- Yackel, E., & Hanna, G. (2003). Reasoning and proof. In J. Kilpatrick, W. G. Martin, & D. Schifter (Eds.), *A research companion to Principles and Standards for School Mathematics* (pp. 227-236). Reston, VA: National Council of Teachers of Mathematics.
- Zaslavsky, O., & Shir, K. (2005). Students' conceptions of a mathematical definition. *Journal for Research in Mathematics Education, 36*(4), 317-346.



# “MAKING PROOF CENTRAL TO PRE- HIGH SCHOOL MATHEMATICS IS AN APPROPRIATE INSTRUCTIONAL GOAL”: PROVABLE, REFUTABLE, OR UNDECIDABLE PROPOSITION?<sup>1</sup>

Gabriel J. Stylianides

University of Pittsburgh

Andreas J. Stylianides

University of California-Berkeley

*Many researchers and curriculum frameworks, especially in the United States, recommend that proof be made central to all students' mathematical experiences as early as the elementary grades. However, the development of proof in school mathematics has been uneven. Proof has historically been associated only with tenth-grade courses on Euclidean geometry. This historical tradition, coupled with the difficulties that even advanced students face with proof, seem to challenge the appropriateness of the goal to make proof central to pre- high school mathematics. In this paper, we use mathematics education and psychological research to examine the appropriateness of this goal. In a PME conference, this paper can initiate fruitful discussions among researchers from different countries and with diverse perspectives on the issue of incorporating proof into pre- high school mathematics.*

## INTRODUCTION

Many researchers and curriculum frameworks, especially in the United States (U.S.), recommend that *proof* become an integral part of *all* students' mathematical experiences and across *all* grades (e.g., Ball & Bass, 2003; NCTM, 2000; Schoenfeld, 1994; Yackel & Hanna, 2003). In the U.S., indicative of the current focus on making proof central to school mathematics is the following excerpt from the *Principles and Standards for School Mathematics*, an influential curriculum framework recently released by the National Council of Teachers of Mathematics (NCTM, 2000):

Instructional programs from prekindergarten through grade 12 should enable all students to recognize reasoning and proof as fundamental aspects of mathematics, make and investigate mathematical conjectures, develop and evaluate mathematical arguments and proofs, select and use various types of reasoning and methods of proof.... Reasoning and proof cannot simply be taught ... by “doing proofs” in geometry.... (p. 56)

Although the current policy and research discourse (at least in the U.S.) is tilted in favor of a widespread presence of proof in the school curriculum, historically proof has been associated only with tenth-grade courses on Euclidean geometry. This historical tradition, coupled with the well documented difficulties that even high school and university students face with proof (e.g., Healy & Hoyles, 2000; Moore, 1994; Reiss et al., 2002), seem to challenge the appropriateness of the goal to make proof central to pre- high school mathematics. Therefore, the examination of the following question becomes critical: *Is pre- high school students' learning of proof*

<sup>1</sup> The two authors had an equal contribution in writing this paper.

*an appropriate goal for school mathematics instruction?* By “appropriate” we refer to both whether this is a worthy educational objective with high priority and whether this objective is feasible (cognitively accessible from a developmental perspective) for the given age group.

In this paper, we focus on the question above, hoping to initiate fruitful discussions among researchers from different countries and with diverse perspectives on the issue of incorporating proof into pre- high school mathematics. These discussions may not only advance the field’s understanding of this issue but also influence policy decisions in different countries about whether, and if so how, to support widespread presence of proof in school mathematics as early as the elementary grades.

In our discussion here, we consider scholarly work not only from mathematics education but also from psychology; it is our observation that relevant psychological studies have not received enough attention by the mathematics education literature on proof. Although most of these psychological studies focus on deductive reasoning rather than on proof, they are absolutely relevant, as there is an intimate relation between the notions of deductive reasoning and proof. In this paper, we use *proof* to denote “a valid argument from accepted truths for or against a mathematical statement” (Stylianides, 2005, p. 38). From a mathematical standpoint, a valid argument is associated with logically necessary conclusions, which directly implicate deductive reasoning. Also, from a psychological standpoint, students’ development of deductive competence has been found to go together with their development of proof competence (e.g., Foltz et al., 1995; Piaget, 1987). Important to note is that an argument that qualifies as proof may be represented in different ways, depending on the modes of representation that are known or conceptually accessible to students at a given time (Stylianides, in press). For example, a proof of the claim “odd+odd=even” can be represented using everyday language, algebra, or pictures (see Stylianides & Stylianides, proceedings of this meeting). Thus, our notion of proof in this paper is associated more with the validity of an argument than with its form.

## **IS IT APPROPRIATE FOR SCHOOL MATHEMATICS INSTRUCTION TO PROMOTE PROOF IN THE PRE- HIGH SCHOOL GRADES?**

Our thesis is that it is appropriate for instruction to promote proof in the pre- high school grades. This position derives from five arguments, which we discuss separately. The first three arguments relate more to whether promoting proof in pre-high school is a worthy educational objective with high priority. The last two arguments relate more to whether this objective is feasible for the given age group.

### **An argument based on the purported relationship between the structure of the discipline of mathematics and the school mathematics curriculum**

The first argument goes as follows: Proof deserves a central place in the K-12 mathematics curriculum and, thus, in students’ mathematical education from the start of their schooling, because: (1) proof holds a central place in the discipline of mathematics, and (2) the school mathematics curriculum should represent the structure of the discipline of mathematics in an undistorted way from the very

beginning. Below we elaborate on the two foundations of the argument, but before we do so we note that the second foundation of the argument is essentially a value statement and, as such, cannot be corroborated or refuted by research.

The first foundation of the argument is based on the fact that proof serves two central functions in the discipline: (a) it is the principal means by which mathematicians establish mathematical truth and derive new knowledge from old, and (b) it promotes mathematical understanding and fosters connections among mathematical ideas.

The second foundation of the argument is based on ideas set forth by general educational scholars such as Bruner and Schwab. Bruner (1960) asserts that there should be “a continuity between what a scholar does on the forefront of his discipline and what a child does in approaching it for the first time” (pp. 27-28). Likewise, Schwab (1978) argues for a school curriculum “in which there is, from the start, a representation of the discipline” (p. 269), and in which students have progressively more intensive encounters with the inquiry and ideas of the discipline.

### **An argument regarding the role of proof in students’ learning of mathematics**

The second argument focuses on the role that proof can play in students’ mathematical education – not as an esoteric or advanced skill, but as a central component of students’ *learning* of mathematics. Specifically, proof can promote in even young students’ mathematical activity functions similar to those it promotes in the discipline of mathematics: it can serve as a mode of establishing what is acceptable mathematically in a classroom community, as a means of supporting students’ process of mathematical discovery, and as a tool for promoting sense making (see, e.g., Ball & Bass, 2003; Yackel & Hanna, 2003).

### **An argument regarding the difficulties that even advanced students of mathematics face with proof**

The third argument turns the problem of even advanced students’ insufficient performance with proof on its head: high school and university students have difficulties with proof not because they are incapable of engaging successfully with it, but because of their abrupt and unsupported introduction to proof at high school (e.g., Moore, 1994; Usiskin, 1987). For example, Usiskin (1987) notes:

[O]f all mathematical areas, justifying, discussing logic and deduction, and writing proofs are major goals only in geometry. Ideas of logic and deduction need not wait until secondary school .... [I]t is still important to give children experience in drawing inferences. Part of the difficulty in dealing with a systematic approach to geometry in secondary school is surely due to the ignoring of any sort of system earlier. (pp. 27-28).

The argument described above suggests that the pre- high school grades can play an important role in the efforts to promote students’ competency in proof. However, a possible criticism of this suggestion is that, even if proof were central to pre- high school students’ mathematical experiences, these students could still not become sufficiently competent in proof when they enter high school. This criticism invites examination of the following question against the existing body of research: Can pre-

high school students reason deductively and engage successfully in proof? The following two arguments focus on the issue of feasibility raised by this question.

**An argument based on mathematics education research regarding the feasibility of the goal to promote proof in the pre- high school grades**

This argument is based on existing research evidence that, as early as the elementary grades and in supportive classroom environments, pre- high school students *can* engage successfully in deductive reasoning and proof (e.g., Ball & Bass, 2003; Stylianides, in press; Zack, 1997). Important to note, however, is that the teaching practices documented in these studies were not typical. Almost all of them were the practices of teacher-researchers. Thus, a major issue here is how deductive reasoning and proof can become central to pre- high school students' learning of mathematics on a *large* scale. This issue, however, goes beyond the scope of our paper.

**An argument based on psychological research regarding the development of students' proof competence and reasoning skills essential for proof competence**

The last argument we present in this paper is based on psychological research that has focused on the development of students' proof competence and reasoning skills (notably deductive reasoning) that are essential for proof competence. Although there is no consensus among researchers on the ages at which students master different reasoning skills, several studies suggest that it is possible to expect from pre- high school students to engage successfully in tasks involving deductive reasoning and proof. Also, a major idea supported by the psychological research in this domain is that the development of students' reasoning skills follows a trajectory that begins from the early elementary grades and continues until the end of the high school grades. Thus, it is imperative that instruction nurtures the development of students' reasoning skills from the start of their schooling, thus helping students to increasingly master these skills. By operating on the erroneous assumption that students are incapable of this kind of reasoning in the pre- high school grades, instruction does not help students develop naturally their emerging reasoning capabilities.

Below we summarize findings of some major psychological studies in this domain. We begin with studies related to the development of proof competence. Next, we present studies that investigate the development of children and adolescents' competence in deductive reasoning and other related reasoning skills (e.g., correct application of rules of inference) that are important for proof competence.

***Development of proof competence***

Piaget (1987) suggested that the development of students' ability for proof construction follows a path toward logical necessity. In his studies, he found that elementary school students generated logical proofs. However, children of this age did not recognize the sufficient character of their proofs. It is only in adolescence that a deductive system is developed and students recognize proof as being sufficient.

Foltz et al. (1995) in a study with fifth- and eighth-graders examined inductive and deductive approaches to the construction of proofs. The lack of significant differences in deductive reasoning ability for the two age groups led the researchers

to cluster together the subjects across grades into categories of formal (deductive), transitional, and nonformal reasoning. The results from this study demonstrate that deductive reasoning competence is associated with a deductive approach to proof construction. Thus, Foltz et al.'s findings support Piaget's earlier findings about an intimate relation in the development of the ability for deductive reasoning and proof construction. However, the findings of the two studies do not seem to agree on the stages of this developmental progression.

Lester (1975) investigated the development of students' ability to write valid proofs by examining developmental aspects of problem-solving abilities (number of tasks solved, number of correct applications of rules of inference, difficulty per task attempted, and total time per task attempted) in an experimental mathematical system. Lester's study included 80 students in the following grade groupings: 1-3, 4-6, 7-9, and 10-12. Lester's findings showed that middle school students (grades 7-9) were as capable of solving problems in the experimental mathematical system as high school students (grades 10-12). Also, when students in the upper elementary grades (grades 4-6) were given some extra time, they were able to solve problems just as successfully as the secondary school students. Students in the lower elementary grades appeared to be less successful. These results suggest that, "certain aspects of mathematical proof can be understood by children nine years old or younger." (p. 23)

### ***Development of reasoning skills that are important for proof competence***

A significant body of research suggests that students' reasoning skills develop with age. Specifically, students' ability for deductive reasoning passes through a developmental progression that extends over the whole range of school years (e.g., Ward & Overton, 1990). However, there is no agreement on when different levels of mastery of deductive reasoning are achieved. Some studies suggest that sophisticated mastery of deductive reasoning and explicit understanding of logical necessity do not emerge before early adolescence (e.g., Markovits et al., 1989; Overton et al., 1987). Some other studies suggest that even preschoolers are capable of drawing deductively valid conclusions (e.g., Hawkins et al, 1984; Richards & Sanderson, 1999).

In order to address the gaps in the existing research, Galotti et al. (1997) investigated students' reasoning skills in kindergarten and grades 2, 4, 6. They concluded:

[Y]oung children can do more than draw deductive and inductive inferences. Even by second grade, they show the beginnings of implicit recognition that these two types of inferences are different and, as is appropriate, show more consistent answering, and higher confidence, in deductive inferences than in inductive inferences (although confidence in deductive answers is not as high as it should be). (p. 77)

Next, we turn to findings of psychological studies on the development of students' ability for other related reasoning skills that are important for proof competence. Klaczynski and Narasimham (1998) in a study with preadolescents, middle adolescents, and late adolescents (mean ages 10, 14, and 17, respectively) report the following about the development of students' ability to draw rules of inference and conditional rules:

[T]he rules for drawing MP [modus ponens] and MT [modus tollens] inferences appear well-developed by early adolescence. Similarly, the rules for generating indeterminant conclusions seem well-defined by early adolescence. This is not, however, to say that conditional reasoning abilities are fully developed before the onset of adolescence. (p. 878)<sup>2</sup>

Braine and Romain's (1983) review of developmental psychology research on logical reasoning shows that the rule for drawing MP inference can be available to 6-year-olds, which is earlier than what is suggested by Klaczynski and Narasimham (1998). Although performance on MT is usually poorer than that on MP, MT can be acquired by second graders. Falmagne (1980) reports further that training can help improve children's ability for MT and to make this ability applicable across different contexts.

With regard to students' ability for *direct reasoning*, Osherson's (1976) investigations suggest that the ability to chain inferences together in short steps of direct reasoning is available to 10-year-olds. Some strategies for *indirect reasoning* – reasoning that departs outside the given starting information – such as setting up all alternatives a priori and working out their consequences to see if they all lead to the same conclusion, seems to become available to children at around the age of 10 (Braine & Romain, 1983). However, some other strategies for indirect reasoning, such as the *reductio ad absurdum*, seem to cause more difficulties. In particular, Braine and Romain (1983) note that, “in maximally propitious circumstances, a half to two thirds of adults and a minority of 10- and 11-year-olds find the reductio ad absurdum solution to Modus Tollens” (p. 290). This result indicates that even more sophisticated forms of indirect reasoning strategies begin to emerge in late childhood. When the previous statement is taken together with Falmagne's (1980) finding that training can improve children's responses on MT and increase their generalization across different contexts, we can infer that supportive classroom environments can facilitate the development of students' reasoning strategies.

## CONCLUSION

This paper has focused on whether making proof central to pre- high school mathematics is an appropriate instructional goal. Our analysis, which utilized research from education and psychology, offers support for the appropriateness of this goal. Nevertheless, translating theoretical ideas and even empirical findings from different studies into instructional practices that ordinary teachers can use to cultivate proof in the classroom requires considerable work. For example, it requires identification of teaching practices that can support effective instruction of proof in the early grades as well as enactment of professional development programs that will help teachers master these practices. A major challenge, but also a primary urgency, for this work is to find fruitful ways to coordinate relevant research in mathematics education and psychology and also to integrate findings from these two fields. As we have shown in this paper, there is a rich body of psychological research that provides a broad portrait of students' emerging reasoning skills that can be used to inform our

---

<sup>2</sup> *Modus ponens* states that if the antecedent of a conditional is true, then the consequent is also true; *modus tollens* states that if the consequent of a conditional is false, then the antecedent is also false.

understanding of when students are expected to overcome innate constraints related to their ability for deductive reasoning and proof. An interdisciplinary and collaborative approach to the problem of promoting proof in even young students' learning of mathematics promises major advancements.

## References

- Ball, D. L., & Bass, H. (2003). Making mathematics reasonable in school. In J. Kilpatrick, W. G. Martin, & D. Schifter (Eds.), *A research companion to principles and standards for school mathematics* (pp. 27-44). Reston, VA: National Council of Teachers of Mathematics.
- Braine, M. D. S., & Romain, B. (1983). Logical reasoning. In J. Flavell & E. Markman (Eds.), *Handbook of child psychology, Vol. 3: Cognitive development* (pp. 263-340). New York: Wiley.
- Bruner, J. (1960). *The process of education*. Cambridge, MA: Harvard University Press.
- Falmagne, R. J. (1980). The development of logical competence: A psycholinguistic perspective. In R. Kluwe & H. Spada (Eds.), *Developmental models of thinking* (pp. 171-197). New York: Academic Press.
- Foltz, C., Overton, W. F., & Ricco, R. B. (1995). Proof construction: adolescent development from inductive to deductive problem-solving strategies. *Journal of Experimental Child Psychology, 59*, 179-195.
- Galotti, K. M., Komatsu, L. K., & Voelz, S. (1997). Children's differential performance on deductive and inductive syllogisms. *Developmental Psychology, 33*(1), 70-78.
- Hawkins, J., Pea, R. D., Glick, J., & Scribner, S. (1984). "Merds that laugh don't like mushrooms": Evidence for deductive reasoning by preschoolers. *Developmental Psychology, 20*, 584-594.
- Healy, L., & Hoyles, C. (2000). Proof conceptions in algebra. *Journal for Research in Mathematics Education, 31*(4), 396-428.
- Klaczynski, P. A., & Narasimham, G. (1998). Representations as mediations of adolescent deductive reasoning. *Developmental Psychology, 34*(5), 865-881.
- Lester, F. K. (1975). Developmental aspects of children's ability to understand mathematical proof. *Journal for Research in Mathematics Education, 6*, 14-25.
- Markovits, H., Schleifer, M., & Fortier, L. (1989). Development of elementary deductive reasoning in young children. *Developmental Psychology, 25*, 787-793.
- Moore, R. C. (1994). Making the transition to formal proof. *Educational Studies in Mathematics, 27*(3), 249-266.
- National Council of Teachers of Mathematics. (2000). *Principles and standards for school mathematics*. Reston, VA: National Council of Teachers of Mathematics.
- Osherson, D. N. (1976). *Logical abilities in children: Reasoning and concepts* (Vol. 4). Hillsdale, N.J: Erlbaum.
- Overton, W. F., Ward, S. L., Black, J. Noveck, I. A., & O'Brien, D. P. (1987). Form and content in the development of deductive reasoning. *Developmental Psychology, 23*, 22-30.

## *Stylianides & Stylianides*

- Piaget, J. (1987). *The role of necessity in cognitive development*. Minneapolis: University of Minnesota Press.
- Reiss, K., Hellmich, F., & Reiss, M. (2002). Reasoning and proof in geometry: Prerequisites of knowledge acquisition in secondary school students. In A. D. Cockburn & E. Nardi (Eds.), *Proceedings of the 26<sup>th</sup> Conference of the International Group for the Psychology of Mathematics Education, Volume 4* (pp. 113-120). Norwich, Great Britain: University.
- Richards, C. A., & Sanderson, J. A. (1999). The role of imagination in facilitating deductive reasoning in 2-, 3- and 4-year-olds. *Cognition*, 72, B1-B9.
- Schoenfeld, A. H. (1994). What do we know about mathematics curricula? *Journal of Mathematical Behavior*, 13, 55-80.
- Schwab, J. J. (1978). Education and the structure of the disciplines. In J. Westbury & N. J. Wilkof (Eds.), *Science, curriculum, and liberal education: Selected essays* (pp. 229-272). Chicago & London: The University of Chicago Press.
- Stylianides, A. J. (in press). Proof and proving in school mathematics. *Journal for Research in Mathematics Education*.
- Stylianides, G. J. (2005). *Investigating students' opportunities to develop proficiency in reasoning and proving: A curricular perspective*. Unpublished doctoral dissertation, University of Michigan, Ann Arbor.
- Usiskin, Z. (1987). Resolving the continuing dilemmas in school geometry. In M. M. Lindquist & A. P. Shulte (Eds.), *Learning and teaching geometry, K-12: 1987 Yearbook of the National Council of Teachers of Mathematics* (pp. 17-31). Reston, VA: NCTM.
- Ward, S. L., & Overton, W. F. (1990). Semantic familiarity, relevance, and the development of deductive reasoning. *Developmental Psychology*, 26(3), 488-493.
- Yackel, E., & Hanna, G. (2003). Reasoning and proof. In J. Kilpatrick, W. G. Martin, & D. Schifter (Eds.), *A research companion to Principles and Standards for School Mathematics* (pp. 22-44). Reston, VA: National Council of Teachers of Mathematics.
- Zack, V. (1997). "You have to prove us wrong": Proof at the elementary school level. In E. Pehkonen (Ed.), *Proceedings of the 21st Conference of the International Group for the Psychology of Mathematics Education* (Vol. 4, pp. 291-298). Lahti: University of Helsinki.



# POWER AND POVERTY – WHOSE, WHERE, AND WHY?: SCHOOL MATHEMATICS, CONTEXT AND THE SOCIAL CONSTRUCTION OF “DISADVANTAGE”

Dalene M. Swanson

University of British Columbia

*This paper compares the discourse and practice of school mathematics in two socio-economically different school contexts in post-apartheid South Africa. It addresses the relationship between constructed “difference” and “pedagogized disadvantage.” In other terms, it looks at the way in which certain students, spoken-of in terms of “deficit” and “disadvantage”, are afforded differentiated school mathematics discourse that situates them in terms of “failure”. Consequently, these socially constructed students are not provided with access to pedagogic or socio-economic empowerment. The paper examines the role of social context in the elaboration of social difference discourses and their recontextualization into mathematics in ways that recruit psychologizing positions, thus pathologizing students and producing disabling pedagogies.*

## **A COMPARATIVE PERSPECTIVE.**

The paper draws on two similarly conducted studies in South African secondary schools. Each study reports on one particular school. Each school is situated in a very different socio-economic context – one affluent, one impoverished. While critical discourse analysis was used to interrogate the range of positions and voices informing the two studies, the theoretical framework draws on the interrelated ideas of discourse, subjectivity, social context and ideology. It provides a sociological interpretation of the role of context and agency in the way in which mathematics is constituted in the two locations, the identities that are constructed in context, and, concomitantly, the ideological positions evoked, including the recontextualization of discourses of psychology in the mathematics classroom in different contexts. The paper compares the two schooling contexts in the two studies. Consequently, a comparison of the two studies permits an examination of the various ways in which these positions are differently or similarly realized across the two schooling contexts.

## **Location of the First Study and Research Intention:**

A small-scale study was conducted within a historic and traditional, independent all-boys Anglican school in South Africa. This secondary school is located in the Western Cape region and has been multi-racial since 1978.

The study commenced during an early period of political transition (post – 1994), during a time of rapid and unprecedented socio-political and economic change in South Africa. These changes culminated in a new political dispensation for the country and have been reflected most poignantly in the educational arena. Whilst these changes posed new alternatives, they also heightened the difficulties faced today in post-apartheid South Africa in an increasingly globalized world, bringing

2006. In Novotná, J., Moraová, H., Krátká, M. & Stehlíková, N. (Eds.). *Proceedings 30<sup>th</sup> Conference of the International Group for the Psychology of Mathematics Education*, Vol. 5, pp. 217-224. Prague: PME. 5 - 217

new focus and new emphases to the socio-economic realities of educational crisis in South Africa and in its future education.

The intention of the study was to examine the *construction of disadvantage* in relation to the discourse of school mathematics within the context of a South African independent school, with particular emphasis on the role of the categories of *race, class, culture and language* in assisting with the formulations and maintenance, (production and reproduction), of such constructions. The *construction of disadvantage* is understood here, to be the production and reproduction of social difference within a hierarchized social domain whose differentiated discourses serve to position individuals (subjects) in terms of deficit and disadvantage. In this way social *difference* is recontextualized (Dowling, 1993) into pedagogic and socio-economic *disadvantage*.

### **Focus of Study and Schooling Context.**

More specifically, the focus of the study was the exploration of *subject positions* potentially available to the black male students of the “Black Scholarship Programme” at the school in their study of school mathematics. On an annual basis, a select number of black students “won” a scholarship to attend this independent school based on the results of an academic entrance examination and a committee selection. The “Black Scholarship Programme”, as it was termed, was financed by a multinational corporation and was designed to provide *advantage* for a select group of students from “disadvantaged communities”. “Disadvantage”, in this (South African) context, is synonymous with “black”, conflating race, class, language difference, cultural difference, “experiential deficit”, poverty and educational difference. These students were constructed in terms of social difference and spoken of in terms of “disability” or “failure”, which legitimized a differentiated distribution of mathematics discourse and practice to these students. These pedagogic practices, in turn, held them to positions of alienation and disadvantage. In this way, constructed difference and disadvantage was *recontextualized* (Dowling 1993, 1995, 1998) into pedagogic disadvantage so that these scholarship students were, in effect, provided with less access to the “regulating principles” (Bernstein, 1993, Dowling 1993, 1998) of mathematics discourse and practice than were other students of the dominant culture constructed in terms of “success”.

The study included an examination of the particular nature of the *schooling ethos and culture*, and its role in creating and maintaining *boundaries*, producing and reproducing forms of power and control that assisted in holding these black students to *positions of subordination*. It was proposed that the hierarchical and differentiating rituals and codes within the “stratified” school context (Bernstein, 1993), with pronounced vertical hierarchies, provided the means by which the Black Scholarship students were constructed as disadvantaged.

Particular emphasis was placed on the discourse of school mathematics within the *Academic Support Programme* of the school, designed to assist these black students “bridge the gap” in their academic knowledge and experience; and in the differentiated nature (through streaming) of the mathematics discourse (Dowling,

1993) available to the students of the Black Scholarship Programme within the *Mainstream Programme*. There was an examination of the power relations between these two discourses and other discourses within the social domain that shaped the way in which these students were positioned in terms of ‘deficit’ and ‘disadvantage’ in relation to other students within the school, and in the way in which psychologizing practices were recruited in terms of notions of ‘competence’, cultural orientation, self-concept and ‘ability’, thereby pathologizing these students and denying them access to enabling pedagogies.

### **Methodological Considerations.**

In this paper, I interrogate the *deficit model* research tradition, where the student is the *object* of the research, context is *neutral* and gender, ethnicity and class become “social factors” that affect educational performance. These social factors are spoken of as possessing deficits which produce “failure”, and become ways of *pathologizing* students in terms of social difference. By contrast, the study places greater emphasis on *the social* and on the *role of context* in the situatedness and production of subjectivity. The study sought to move away from approaches which attempt to explain differences in performance on the basis of measured differences in cognitive or affective traits, or ethnic background. Such approaches, I argue, displace *the social* to secondary account and focus on the individual as an ensemble of abilities, attitudes, beliefs, perceptions and experiences. Through my research focus on *context, subjectivity, discourse, and ideology*, with an emphasis on post-structural theory and critical pedagogy, I sought to provide an alternative reading of educational difference through an examination of the *construction of disadvantage* in terms of the *subject positions* available to the students of the Black Scholarship Programme, in relation to school mathematics. The differentiated subject positions, which were afforded this group of students, worked concomitantly with the *unequal distributions* (Dowling, 1993, 1998) of mathematical discourse and practice to these students. In other terms, these students were held to positions of subordination in relation to other more “successful” students, which served to delimit their access to the “regulating principles” of mathematics discourse and practice and to its rules of evaluation.

### **Data Collection.**

The students of the Black Scholarship Programme were interviewed in their initial year at the secondary school (grade eight) as were the two teachers of the Academic Support Programme. These semi-structured interviews were designed to establish a discourse on teaching and learning mathematics within this independent school, especially in relation to the Black scholarship students and their mathematics. The discussions were taped and transcribed and formed the basis of the analysis. The intention was to examine the various ways in which the teachers constructed the Black Scholarship students in relation to other students and their mathematics, and to compare it with the ways in which the Black Scholarship students constructed themselves and other students with respect to mathematics within the context of this independent school. Informal discussions with students of the Programme in their more senior academic years were also documented. Field notes were taken of

discussions with academic staff within the Mathematics Department and school documentation reflecting school policies and discussions within the school were used, where relevant, in relation to the students of the Black Scholarship Programme and mathematics. Archival material documenting the history of the school was researched and discussions with teachers with a long-standing career at the school were documented.

## Findings of First Study

### *The school context and disadvantage*

In the context of the research school, I argued that it was the specific agents of power and control that assisted in boundary formation and regulation within and between school discourses: “the social division of labour of discourses” (Bernstein, 2000). The relations of power between discourses, such as *Mainstream Mathematics* and *Academic Support* assisted in positioning subjects in terms of ‘dominance’ versus ‘subordination’ in relation to these discourses.

The research school possessed a highly ritualized social order and was described in terms of its many *differentiating* and *consensual* rituals (Bernstein, 1990, 1993, 2000), which reproduced difference in the school. This “ritualization of difference” allowed one to speak of the pervading ideological ethos of the school in terms of “the culture of difference”. As a consequence of the dominant discourses within the school (recontextualized from discourses within the social domain), difference was *stratified* and translated into deficit and disadvantage in a more explicit and visible way in the case of the students of the Black Scholarship Programme with respect to mathematics and in relation to other students within the school. It was the patterns of meaning, constructed through ritual and tradition at the school, which provided the resources for constructing disadvantage in such an explicit way, and consequently, constructions along the lines of race, class, cultural deprivation, experiential deficit, language difference, and intellectual disability were indexed over others. Consequently, pathologies of the scholarship students were normalized in this context. Positions of “success” became less available to the students through normalization, so that positions of resistance reinforced “disadvantage,” and disallowed possibilities for empowerment.

### *Pedagogic discourse and disadvantage*

In the analysis, I argued that the power relations between the discourses of Academic Support and Mainstream Mathematics constrained options and delimited possibilities of successful engagement in mathematics. For the students of the Black Scholarship Programme, this meant that access to the *regulating principles* (Dowling, 1993) of “upper stream” mathematics was prevented, rather than facilitated, despite the Academic Support Programme. The *strong classification and framing* (Bernstein, 1993, 2000) of Mainstream Mathematics illegitimized and nullified the intended “advantages” of the *weakly classified* Academic Support Programme. The “regions of silence” between the discourses, prevented access to the realization rules (Bernstein, 1993) of mathematics. The students were thus subordinated along with the low status

of the bridging program. Their spatial separation from other “successful” students, both within the Mainstream and Academic Support, became a *physical and contextual* representation and demarcation of this subordinate positioning.

### ***Disadvantage realized in pedagogic discourse***

In the analysis, I argued that a differential distribution of mathematical discourse was produced across a hierarchical array of subject positions or voices (Dowling, 1993). To the *alienated voice* of the students of the Black Scholarship Programme was distributed recontextualized discourse that did not provide access to the regulating principles of mathematics at the school. These students were alienated from “upper stream” mathematics as a consequence of being placed with “lower set” students who carried constructions of unsuccessful, slow or disabled learners. Further, their presence in the Academic Support classroom with its *weak voice* (Bernstein, 2000) reaffirmed their position of subordination, where they were granted access to procedural practices and mere rules rather than the regulating principles of school mathematics.

### **First Study: Conclusion**

In this way, *disadvantage produced disadvantage* - the students of the Black Scholarship Programme carried a construction of disadvantage, which became the means by which they were disadvantaged mathematically within the school, despite any attempts of theirs to locate positions of resistance. The selectivities and emphases that supported and assisted in the constitution of representations of “educational difference”, entered into the construction of disadvantage. This disadvantage was realized in pedagogic discourse and practice within the school. In other words, the construction of disadvantage worked empirically with the *pedagogizing of difference* in the research school, and perpetuated pathologizing practices that prevented the engagement with enabling pedagogies.

### **The Second Study and Research Intention**

The school referred to in the second study was situated within an “impoverished” community in an informal settlement in the Western Cape region of South Africa. Research for this study was undertaken in mid-2001 over a three month period. The study was premised on similar methodological principles as the first study and served to extend the discussion on school mathematics and constructed “disadvantage”, from a critical sociological perspective, with a further emphasis on context, both schooling and the broader political context. A principle intention of the study, as with the first, was to examine the relationship between the ways in which students (and teachers) were socially constructed and the kinds of practices afforded the students in different socio-economic and educational contexts. The emphasis on the second study was to examine the relationship between constructed “disadvantage” and the pedagogizing of difference, but especially how this might be realized in-and-across contexts.

### **Data Collection**

As in the first study, the data collection took the form of a set of interviews with groups of students, their teachers in separate interview sessions, as well as participant

observation. Some of the interviews were with individual students where this was the preferred method to the student. These interviews were taped and became, in part, the data of the narrative-based research. These were complimented with a set of observations of secondary mathematics classes across a range of grades and copious field notes were taken. The principal of the research school was also interviewed.

### **Findings of Second Study in relation to the First.**

In the case of the second research school, the “failure” in school mathematics was more *visibly* established and less of a hierarchy was produced between “successful” and “unsuccessful” students in this context. In this way, the students tended to be homogenized in terms of “poverty”, and, consequently, race, class, “social problems”, “learning difficulties”, and other experiential deficits. Whilst the first study showed that hierarchies produced *within* the stratified research school strongly *reflected* hierarchies within the broader social and political domain, the second study showed how schooling within this “disadvantaged” community reflected discourse and practice that situated and pathologized the school and schooling context *more directly* in terms of the broader social and political context. Almost no positions of resistance with respect to school mathematics appeared to be available to the students in the second impoverished school compared with those constructed in terms of social difference in the independent school. In other words, the schooling community, being less empowered, was deeply embedded and oppressed by the existing social relations and political conditions of its place and time. Consequently, there appeared to be little possibility for contested terrain *within* the community that would enable its students to be provided with access to the regulating principles of mathematics and facilitate their pedagogic, socio-economic and political empowerment.

### **THE STUDIES: EDUCATIONAL SIGNIFICANCE**

The two studies, therefore, propose an alternative reading of educational and social difference to that espoused within the deficit model approach, often supported by psychologistic modes of research engagement. They provide an understanding of the role of context in the production of subjectivity and the manner in which discourses within the broader social domain, as well as the schooling context, differentiate groups of students in accordance with social difference. To these students are distributed differentiated distributions of discourse and practice which are disempowering and situate them in the mundane. Different contextual realizations produce a difference in availability of positions of resistance. However, oppressive contextual features severely limit options and possibilities for transformative engagement with enabling pedagogies.

The studies serve to alert the education community to the contextual complexities of mathematics education in different South African schools and to the specific socio-economic and political realities that remain a challenge for the future. Further, the studies have critically important implications for other socio-political and geographic contexts where students from diverse communities, constructed in terms of social difference, are not well served in their mathematics learning within schools.

## References

- Bernstein, B. (1990). *Class, Codes and Control*, volume IV. London: Routledge and Keegan Paul.
- Bernstein, B. (1993). Pedagogic Codes and their Modalities. *Hitotsubashi Journal of Social Studies* Vol. 25 Special Issue.
- Bernstein, B. (2000). *Pedagogy, Symbolic Control and Identity: Theory, research, critique*. NY: Rowan & Littlefield.
- Dowling, P.C. (1990a). Some Notes Towards a Theoretical Model for Reproduction, Action and Critique, in Noss, R. et al (Ed.s.), *Political Dimensions of Mathematics Education: action and critique, proceedings of the 1st international conference*. London: Department of Mathematics, Statistics and Computing, Institute of Education, University of London.
- Dowling, P.C. (1990b). The Shogun's and Other Curricular Voices. In P. C. Dowling and R. Noss (Eds.). *Mathematics versus the National Curriculum*. Basingstoke: Falmer.
- Dowling, P.C. (1990c). Mathematics in the Marketplace: the National Curriculum and Numerical Control. *Teaching London Kids*, 26, 28 – 31.
- Dowling, P.C. (1991a). A Touch of Class: ability, social class and intertext in SMP 11 – 16. In D. Pimm and E. Love, (Eds.). *Teaching and Learning School Mathematics*. London : Hodder and Stoughton.
- Dowling, P.C. (1991c). Gender, Class and Subjectivity in Mathematics: A Critique of Humpty Dumpty. *For the Learning of Mathematics*, 11, 2 - 8.
- Dowling, P.C. (1992b). Pedagogic Voices, Pedagogic Messages: a sociological algebra, presented at Research into Social Perspectives into Mathematics Education, Southbank University, May 1992, (available from Department of Mathematics, Statistics and Computing, Institute of Education, University of London).
- Dowling, P.C. (1993). *A Language for the Sociological Description of Pedagogic Texts with Particular Reference to the Secondary School Mathematics Scheme SMP 11-16*. PhD Thesis, Institute of Education, University of London.
- Dowling, P. C. (1998). *The Sociology of Mathematics Education*. London: Falmer Press.
- Ensor, M.P. (1991). *Upsetting the Balance: Black Girls and Mathematics*. MSc Thesis, Institute of Education, University of London.
- Ensor, M.P. (1996). Looking Straightforwardly, Looking Awry: Taking a view on the subject of interviewing. In D. Bensusan, (Ed.) *W(h)ither the University?* (pp. 249-266). Kenton-at-Wilgerspruit, Kenwyn: Juta.
- Swanson, D.M. (1998). *Bridging the Boundaries? A Study of Mainstream Mathematics, Academic Support and "Disadvantaged Learners" in an Independent, Secondary School in the Western Cape, (South Africa)*. Unpublished Master's dissertation, University of Cape Town, South Africa.
- Swanson, D. M. (2000, November). Teaching Mathematics in Two independent School Contexts: The Construction of "Good" Practice". *Educational Insights*, 6(1). Online journal: <http://www.csci.educ.ubc.ca>

Swanson

- Swanson, D.M. (2004). *Voices in the Silence: Narratives of disadvantage, social context and school mathematics in post-apartheid South Africa*. Unpublished Ph.D. dissertation, The University of British Columbia.
- Swanson, D.M. (2005). School Mathematics: Discourse and the Politics of Context. In A. Chronaki and I. Christiansen (Eds.) *Challenging Perspectives on Mathematics Classroom Communication*. (pp. 261-294). Greenwich, CT: Information Age Publishing.
- Walden, R. and Walkerdine, V. (1987). *Girls and Mathematics: The Early Years*. Bedford Way Paper No. 8, Institute of Education, University of London.
- Walden, R. and Walkerdine, V. (1988). *Girls and Mathematics: From Primary to Secondary Schooling*. Bedford Way Paper No 24 University of London Institute of Education.
- Walkerdine, V. et al. (1989). *Counting girls out*. London: Virago.
- Walkerdine V. (1990). *The Mastery of Reason: cognitive development and the production of rationality*. London: Routledge.



# DOCUMENTING LEARNING IN SCHOOL-BASED MATHEMATICS COMMUNITIES OF TEACHERS

Paola Sztajn

University of Georgia<sup>1</sup>

*The goal of this theoretical paper is to promote discussion about different ways to perceive and document teacher learning in professional development initiatives based on communities of mathematics teachers working in close connection to their practices. Toward this goal, I consider different perspectives on learning and use examples from a 3-year professional development project to propose other ways to look at learning within communities of mathematics teachers. I suggest that changes in the topics and patterns of conversations, in the visibility of mathematics within the school, and in the school support structure for mathematics instruction are possible ways to look at teacher learning in communities of practice.*

## INTRODUCTION

Those who work with the professional development of practicing mathematics teachers in the U.S. are facing two calls for action. First, there is a growing movement to bring professional development closer to teachers' experiences, involving groups of teachers in activities tightly connected to teaching practices. Second, there is a push for closer scrutiny of professional development initiatives to show how they impact teaching. Taken together, these demands require that those who work with communities of mathematics teachers demonstrate the effect of their professional development programs. One important question, which is the focus of this study, emerges from this scenario: what does effect mean in the context of communities of teachers?

The goal of this theoretical paper is to promote discussion about different ways to perceive and document teacher learning in professional development initiatives that promote the development of communities of mathematics teachers. Toward this goal, I briefly present the current calls for communities of teachers and for documenting the effect of professional development. I bring these calls together through an analysis of different perspectives on learning, examining what learning might mean in professional development initiatives that involve communities of teachers. I propose other ways to look at learning within communities of mathematics teachers.

This paper builds on the work developed in a three-year professional development program for elementary mathematics teachers (Sztajn, Alexsaht-Snyder, White, & Hackenberg, 2004; Sztajn, White, Hackenberg & Alexsaht-Snyder 2004; White, Sztajn, Alexsaht-Snyder & Hackenberg, 2004). This project collected no data on individual teachers. Based on the difficulties faced when trying to show the effects of this professional development initiative, the research team<sup>ii</sup> began to discuss ways to document learning when the only data available were videotapes from whole-school mathematics meetings and documentation of mathematical activities at the school. The goal was to understand how to account for the evident changes in the role

2006. In Novotná, J., Moraová, H., Krátká, M. & Stehlíková, N. (Eds.). *Proceedings 30<sup>th</sup> Conference of the International Group for the Psychology of Mathematics Education*, Vol. 5, pp. 225-232. Prague: PME. 5 - 225

mathematics played in this community as it moved from an outside position (only two out of 22 had completed any mathematics in-service activity in the five years prior to the project) to the center of attention of the school community.

## **FRAMEWORK: PRACTICE, COMMUNITIES, AND EFFECTIVENESS**

In the professional development literature, the need to connect experienced teachers' learning to their practices has long been considered. In 1993, Little questioned the fit between reform proposals and available professional development opportunities for teachers. She claimed that professional development should explicitly consider the experiences of teachers and she questioned the value of "the context-independent, 'one size fits all' mode of formal staff development that introduces largely standardized content to individuals whose teaching experience, expertise, and settings vary widely" (p. 138). In this model, no attention is given to the fit between the ideas being presented and teachers' habits or teaching circumstances.

Loucks-Horsley, Hewson, Love and Stiles (1998) also criticized such approach to professional development, stating that although these initiatives "may be a good kick-off for learning and can result in new knowledge or awareness on the part of participants, additional opportunities are needed for long-lasting change" (p. 93). They suggested that this professional development approach should be combined with opportunities and support for teachers to translate and implement their new knowledge into their practice. Wilson and Berne (1999) examined exemplary professional development projects that conducted research. They observed that all the projects involved communities of learners who were "redefining teaching practice"(194) and privileged "teachers' interactions with one another" (p.195).

Together, these (and many other) studies of professional development suggest that for professional development to impact teaching, it needs to take teachers' experiences into account and support teachers while giving them time to try new ideas in their school and classroom settings. Furthermore, teachers need to work with other teachers in communities of practice. Despite the appeal of these suggestions, projects that have tried to take them into account have struggled with how to document their impact on teachers (Wilson & Berne, 1999).

Floden (2001) used the term "effects of teaching" to denominate the "goal of identifying associations between characteristics of teaching and student learning" (p. 4). He contended that in the context of professional development, the concept of effect relates professional development teaching to teacher learning. Thus, effective professional developments are those initiatives in which teachers gain something. Floden indicated that different approaches are needed to document the effects of teaching in general and, in this paper, I consider some of these approaches for documenting the learning of teachers in mathematics education communities.

One example of a professional development project that has measured its effect is the Cognitively Guided Instruction (CGI). Fennema et al. (1996) studied the impact that learning about children's thinking had on teachers. They classified 21 teachers at the beginning and the end of the project according to four CGI instructional levels.

Eleven of the eighteen teachers who started at level one or level two went to level three; five teachers went to level four in the span of the project. Franke, Carpenter, Levi and Fennema (2001) also searched for the long-term effect of CGI. Four years after teachers had completed the program, they observed and interviewed 22 teachers. Sixteen were still at the level at which they had ended the project; five had gone down one level and one was two levels higher. A few teachers had engaged in what the authors called generative growth. These teachers saw the knowledge they gained through CGI as theirs and continued to develop it through practice.

Similarly to CGI, other professional development initiatives in mathematics education have looked at teachers' growth as effect of teaching. Underlying this approach is the assumption that learning is an individual phenomenon in which teachers gain knowledge and transform their practice. Thus, there is a mismatch between the approaches used to measure effect (based on the individual) and the call for changes in the design of professional development to become better connected to teachers' practices and therefore more effective (based on the collective).

### **LEARNING AND THE EFFECT OF PROFESSIONAL DEVELOPMENT**

Human learning has typically been conceived as an individual acquisition (Sfard, 1998). Claims about what one should acquire and how one does it may differ between learning theories such as behaviorism and constructivism. However, both perspectives, as most learning theories, subscribe to the acquisition metaphor for learning. Within this metaphor, learning means that a person "gains" knowledge. A very different metaphor for learning is one that substitutes the idea of acquisition for the idea of participation, and the concept of knowledge for the notion of knowing—not something you have in yourself but something you do in a group. Within this perspective, learning is "conceived as a process of becoming a member of a certain community" (Sfard, 1998, p. 6), or "a reorganization of activities accompanying the integration of an individual learner with a community of practice" (Sfard, 2003, p. 355).

In measuring the effects of professional development, researchers have usually adopted an acquisition perspective. Although looking at individual teachers from the acquisition perspective affords an important view of teacher learning, it is also necessary to consider the effect of professional development from a participation perspective. Balancing both metaphors (Sfard, 2003), professional developers can have new insights about the effect of their programs. Thus, using a participation view of learning is an important step toward understanding the effect of professional development initiative that engage groups of teachers in learning from practice.

A few studies in mathematics education have begun to seek this alternative. Stein and Brown (1997) used the notion of learning as increased participation in the practice of a group (Lave & Wenger, 1991) to study teachers in a reform mathematics education community. They examined the activities in which teachers engaged over the years, including the courses teachers taught, their work as resource teachers, or presentations made for external audience. They noticed that teachers participated in a wider variety of activities as they moved from "new comers" to "old timers" within

the community. The breadth of teachers' activity was the authors' approach to characterize learning in the community.

Stein and Brown (1997) also considered learning in a setting where a mathematics education community was not established. For this scenario, they used Tharp and Gallimore's (1988) framework of learning as assisted performance. They analyzed how teachers in the project and the external support person aligned their goals and started to plan cooperatively. As the project evolved, the support person began handing work over to the teachers, increasingly withdrawing from the role of assisting teachers. This move from assisted to independent performance characterized learning in the community.

Franke and Kazemi (2001) explored what a community of practice perspective would mean for the concept of generative knowledge. They expanded their conception of teachers' practice to include informal interactions with colleagues or professional development engagement. They used the stories told by teachers as ways to capture teachers' development of their identities (Lave, 1996). Changes in mathematics teachers' professional identities represented learning in this study.

## **LOOKING FOR OTHER ACCOUNTS OF LEARNING IN A PROFESSIONAL DEVELOPMENT COMMUNITY OF PRACTICE**

The examples mentioned begin to account for learning in settings in which the community is more than the stage for individual gains. Knowing how to document the effect of professional development from this perspective is a new task for mathematics teacher educators. Therefore, developing ways of understanding teacher learning as participation in communities is needed. The suggestions that follow come from my experiences in the Teacher Quality-funded project SIPS (Support and Ideas for Planning and Sharing in Mathematics Education) and from the initial analysis of videotapes of SIPS meetings and documents. This analysis aimed at raising issues and developing possibilities for creating a conceptual analytical framework in which to measure knowledge acquisition and conduct research within the SIPS project.

SIPS was a three-year, school-based professional development initiative designed to improve mathematics instruction by bringing schoolteachers and university mathematics educators together to build a mathematics education community within an urban elementary school. All classroom teachers at the school were involved in SIPS activities during the three years of the project. Two activities were at the core of the project: worksessions and mathematics faculty meetings. The former were grade-level meetings, focused on sharing available mathematics resources and collectively planning instruction. The latter involved all teachers and allowed for communicating teaching practices across grade level.

All mathematics faculty meetings and worksessions were documented, either through video data or through notes and detailed minutes. Researchers in the project kept field notes and teachers were asked to complete meeting evaluations. Although members of the professional development team worked with individual teachers, co-planing and co-teaching lessons in various classrooms, the project did not have classroom

data on any of the teachers. The only data the project had on individual teachers were their reports of classroom activities during faculty meetings—either about particular students, mathematical tasks, or the work with the SIPS facilitators in the classroom. These data were not suitable for documenting or studying learning from an acquisition perspective.

Over the life of the project, however, many changes were made to the organization of the mathematics activities, the structure of mathematics faculty meetings, and the role of mathematics at the school. This paper is an approach to considering aspects of these changes as learning from a participation metaphor.

Some changes found in teachers' participation in SIPS can be captured through an analysis of the *patterns and topics of conversation* during SIPS meetings. In initial SIPS meetings, conversations were structured as a set of dialogues between individual teachers and the mathematics educators (with other teachers as listeners). As the community developed, teachers began talking to each other, listening to each other's stories, and valuing themselves as sources of knowledge for the community. A hub and spoke diagram showing who speaks to whom in the SIPS community, similar to those used by Nathan and Knuth (2003), would show similar patterns as those encountered in that article—that is, a decentralization of the conversation. This decentralization did not represent a change in the orientation of the professional development activity but, rather, a change in teachers' participation in these activities.

At the same time, as teachers increased their participation, the topics of the conversations that emerged in faculty meetings also changed. Teachers stopped focusing their comments on what children could not do, blaming students for their difficulties, and became interested in what children actually did. One task often given to teachers by the professional development team was to share what students could do. SIPS facilitators asked teachers for detailed descriptions of how students answered questions, how they carried out computations, etc. This attention to what children could do became part of the culture of the group, and teachers started reporting on it without being triggered by SIPS staff. As the community learned to pay attention to and value the children, teachers stopped sharing stories about the “silly” things children said to talk about the “interesting” mathematical explanations their students had to offer.

Other changes the SIPS community experienced were related to the *visibility of mathematics* in the school. When SIPS began, teachers had not participated in mathematics-related professional development for a long time. Mathematics was not part of teachers' daily conversations, it was not present in the school hallways, and it was not a topic in which teachers shared resources. As SIPS developed, teachers began talking more about mathematics (even outside of SIPS meetings). Such conversations became evident as it became common for the mathematics educators to share an activity with one teacher and have other teachers ask for more information. Teachers also started to display children's mathematical work on the boards around the school. These boards, previously filled with language and art activities began to

exhibit graphs, patterns, shapes and other mathematical explorations done by the students. The school expanded the mathematics family night program from one to four nights a year, and parents came to participate in the mathematics activities. Teachers also increased time for mathematics instruction (from 60 to 90 minutes), which required them to come up with more engaging activities. Overall, mathematics became an integral component of life in the school, going beyond the classroom walls to become part of the school culture.

Changes initiated by the SIPS community also promoted changes in the *school support structure* for mathematics instruction. For example, in the first year of SIPS the project “bought” time for teachers to have collective planning activities. During the second year of SIPS, the school schedule was reorganized so that teachers from the same grade level had planning periods at the same time. SIPS used these times for worksessions. In the third year, the school created professional development times during school hours, besides planning times. During these times, teachers got together to study or collectively plan activities (alternating weeks for mathematics and for language-arts), thus SIPS worksessions became part of the school routine and culture. The school hired new personnel to support this activity and allowed teachers work collectively in improving mathematics instruction. The school also directed funds to create a mathematics resource area in its media center, giving teachers access to a variety of teaching materials for mathematics instruction. With the support of SIPS, teachers selected and bought manipulatives and books that they needed. By having these materials at the school media centre, available for check out, teachers made them accessible to the whole community.

## **DISCUSSION**

In this paper, I focused on the question of what effect means in the context of professional development activities that foster the development of communities of mathematics teachers. I argued that a change from an acquisition to a participation metaphor can help mathematics teacher educators understand learning in these communities, beginning to document the effects of professional development. However, to embrace a participation metaphor and account for learning that is not based on the individual acquisition of knowledge, researchers will have to refocus their attention on teachers’ activities and redefine both what counts as learning and how we can measure it. Breadth of teachers’ activities in the community, their move from assisted to independent performance, and changes in identities are some ways already considered for examining learning within mathematics communities. I suggest that changes in the topics and patterns of conversations, in the visibility of mathematics within the school, and in the school support structure for mathematics instruction are also some possible ways to look at teacher learning in professional development initiatives that are based on the development of communities of practice.

Understanding what a participation perspective on learning entails to the study of professional development initiative that aim at working with communities of teachers in close connection with practice is important for it allows better alignment between

the design of many current professional development projects and the measure of their effects. New approaches to measure effect need to emerge. Thus, a broad discussion of what learning from practice means in communities of teachers, together with an analysis of methodologies to better capture such learning, can greatly enhance the current conversation about mathematics teachers' professional development.

## References

- Fennema, E., Carpenter, T. P., Franke, M. L., Levi, L., Jacobs, V. R., & Empson, S. B. (1996). A longitudinal study of learning to use children's thinking in mathematics instruction. *Journal for Research in Mathematics Education*, 27(4), 403-434.
- Floden, R. E. (2001). Research on effects of teaching: A continuing model for research on teaching. In V. Richardson (Ed.), *Handbook of research on teaching* (Fourth ed., pp. 3-16). Washington, DC: AERA.
- Franke, M. L., Carpenter, T., Levi, L., & Fennema, E. (2001). Capturing teachers' generative change: a follow-up study of professional development in mathematics. *American Educational Research Journal*, 38(3), 653-690.
- Franke, M. L., & Kazemi, E. (2001). Teaching as learning within a community of practice. In T. Wood, B. S. Nelson & J. Warfield (Eds.), *Beyond classical pedagogy: Teaching elementary school mathematics* (pp. 47-74). Mahwah, NJ: Lawrence Erlbaum Associates.
- Lave, J. (1996). Teaching as learning in practice. *Mind, Culture and Activity*, 3, 149-164.
- Lave, J., & Wenger, E. (1991). *Situated learning. Legitimate peripheral participation*. Cambridge: Cambridge University Press.
- Little, J. W. (1993). Teachers' professional development in a climate of educational reform. *Educational Evaluation and Policy Analysis*, 15(2), 129-151.
- Loucks-Horsley, S., Hewson, P. W., Love, N., & Stiles, K. E. (1998). *Designing professional development for teachers of science and mathematics*. Thousand Oaks, CA: Corwin Press.
- Nathan, M. J. & Knuth, E. J. (2003). A study of whole classroom mathematical discourse and teacher change. *Cognition and Instruction*, 21 (2), 175- 208
- Stein, M. K., & Brown, C. A. (1997). Teacher learning in a social context: Integrating collaborative and institutional processes with the study of teacher change. In E. Fennema & B. S. Nelson (Eds.), *Mathematics Teachers in Transition* (pp. 155-191). Mahwah: JN: Lawrence Erlbaum Associates.
- Sztajn, P., Alexsaht-Snyder, M., White, D. Y., and Hackenberg, A. (2004). School-based community of teachers and outcomes for students. In M. J. Hoines and Fuglestad, A. B. (Eds.) *Proceeding of 28<sup>th</sup> Conference of the International Group for the Psychology of Mathematics Education*, Volume 4, pp. 273-281. Bergen, Norway: Bergen University College.
- Sztajn, P., White, D. Y., Hackenberg, A., and Alexsaht-Snyder M. (2004). Developing trusting relations in the in-service education of elementary mathematics teachers. *Thematic Afternoon, 10<sup>th</sup> International Conference in Mathematics Education*. Copenhagen, Denmark. Available on [www.icme-10.dk](http://www.icme-10.dk)

Tharp, R., & Gallimore, R. (1988). *Rousing minds to life: Teaching, learning and schooling in context*. Cambridge, UK: Cambridge University Press.

Wilson, S. M., & Berne, J. (1999). Teacher learning and the acquisition of professional knowledge: an examination on contemporary professional development. In A. Iran-Nedjad & P. D. Pearson (Eds.), *Review of Research in Education* (Vol. 24, pp. 173-209). Washington, DC: AERA.

White, D. Y., Sztajn, P., Alexsaht-Snyder, M., and Hackenberg, A. (2004). Building a mathematics education community that facilitates teacher sharing in an urban elementary school. In D. E. Dougall and J. A. Ross (Eds.) *Proceedings of the twenty-sixth annual meeting of the North American Chapter of the International Group for the Psychology of Mathematics Education* (pp. 977-984). Toronto: OISE/UT.

---

<sup>i</sup> Time for preparation of this report was supported by the National Science Foundation under Grant No. ESI-0544543. Any opinions, findings, and conclusions or recommendations expressed in this material are those of the author and do not necessarily reflect the views of the foundation.

<sup>ii</sup> The author would like to acknowledge the work of Dr. Dorothy Y. White as the co-director of this professional development program.



# RESEARCH AND TEACHING – CAN ONE PERSON DO BOTH? A CASE STUDY

Michal Tabach

The Weizmann Institute of Science

*In the last two decades, it seems that the border between teaching and research has become blurred. Teachers are doing research in their classrooms, while researchers are turning to teaching the population they are investigating. This article is an introspective one, in which I exemplify this issue through my own experience of teaching and doing research in parallel. A short analysis is presented of the various roles of teachers and researchers. I then present a case study in which I held both roles simultaneously---researcher and teacher. I describe the strategies I used to distinguish between the two roles, as well as examples of synergy and clashes between them. The case study is used as an example to illuminate possible gains and losses in holding such a dual role.*

In mathematics education, being teacher and researcher are two related roles. For one or two decades now, we have been observing a phenomenon in which people are deciding, or feeling the need to "serve" in both roles---teaching and research. In this presentation, I take an introspective stand, as I trace my own professional development from a teacher, to a teacher involved in research, to a researcher-teacher. While examining my path, I will refer to the similarities and differences between the two practices, and examine two types of mixed practices: teacher-researcher and researcher-teacher. I will present the case of my Ph.D. study, as an example illustrating the synergy and clashes that might occur while fulfilling the two roles in parallel.

I started my path in the mathematics education community as a teacher. During my second year as such, I became an experimenting teacher in the *CompuMath* project (Hershkowitz et al., 2002). I was given new curriculum materials, and I tried them in my class with my students. I was asked to reflect on the given activities, and was encouraged to make my own suggestions regarding ways of improving teaching/learning processes. In addition, during one lesson per week, an experienced researcher came to my classroom to observe and analyze learning. I very quickly became a member of the research team and found myself involved in reflective talks regarding the materials and classroom events.

## DIVERSITY OF TEACHER AND RESEARCHER PRACTICES

The differences between the practices of teaching and research can be examined in terms of several aspects, among them the training processes, the goals, and roles in the classroom. I examine each of these aspects here.

## **The training process**

The educational backgrounds of a teacher and researcher differ: the teacher specializes in domains and aspects related to the contents s/he teaches (content knowledge), general pedagogical aspects (pedagogical knowledge), and aspects relating to the pedagogical knowledge of the contents s/he teaches (pedagogical content knowledge) (Shulman, 1986). The researcher's academic background and training include content knowledge, knowledge regarding the research literature in the field of study. A researcher should be familiar with a variety of research tools, with ways of matching research questions, methodologies, tools, and data analyses.

Common issues in teachers' and researchers' education are areas of the topic of specialization (i.e. mathematics), basic cognitive psychology and possibly, learning theories. But even when learning the same topics, the emphases are different.

## **The initial goals**

A teacher and a researcher in the same class have different goals. The teacher's goals vary from general educational goals, relating to values and norms, through general goals which are related to mathematics itself (such as gaining skills and language), to goals relating to specific content knowledge. The teacher's aims include students' understanding, students' success in examinations, students' interest, involvement and even enjoyment of mathematics. The researcher's goal is to answer a research question (or questions) s/he posed, by collecting relevant data for the research.

## **Role in the classroom**

The aforementioned differences in goals express themselves in the roles of the teacher and researcher in the classroom. The teacher is responsible for classroom organization---both physical and mental (i.e. the physical organization of the classroom and the students, creating learning sequences according to teaching goals, curriculum, and so on). The teacher must instantly respond to students' needs, distribute his/her attention among the students, follow individual students (who need help), and solve problems which do not relate to learning (e.g., discipline problems). The intensity of the interactions among the teacher and students in the classroom dictates the teacher's instant reactions during lesson time. Such reactions are based on a combination of the teacher's knowledge, experience and intuition. However, a reflective teacher may examine the outcomes of her/his reactions and their influence on the course of events, and may modify her/his reactions to classroom happenings, to put learning back on the "right course" (Novotna et al., 2003). Teacher reactions and initiatives are guided by students' interests (from both affective and cognitive aspects), and the singularity of the situation (Labaree, 2003).

In contrast, the researcher is not responsible for classroom occurrences. S/he is motivated by the need to know and understand what is going on and why (Labaree, 2003). The researcher wishes to understand the sources of a certain thinking process or strategy students followed, sometimes regardless of the learning that did or did not take place. To achieve this, the researcher may sit near a small group of learners and

observe their work from start to finish, as it is happening. Meanwhile, the teacher is moving among all the learners, watching parts of the learning processes of many students. The researcher will usually record observations, and hence can observe events and episodes, in an attempt to analyze and understand what happened from different perspectives, and to suggest interpretations and conclusions.

The functions of the researcher and teacher might align while interacting with students, and asking questions. The teacher's goal is to listen (even if the teacher is listening in order to plan his/her next step, and not necessarily to completely understand the learning processes), and in this respect, s/he might resemble the researcher.

Both teacher and researcher function as designers: the teacher chooses curriculum materials s/he may adopt and change to suit instructional goals. A researcher might design his/her research tools, or adapt existing tools. Yet, the design goals are different.

### Summary

Given the differences in training, aims and functions, it appears that research and teaching are so far apart that the gap could never be bridged. This issue has been referred to in the literature (Labaree, 2003). However, one of the research goals in mathematics education is an understanding of learning processes in order to improve teaching. There are descriptions of professional developmental processes that include the alternating performance of teaching and research, which specifically claim that the two points of view complement and empower one another (Magidson, 2005).

### THE TEACHER-RESEARCHER VERSUS RESEARCHER-TEACHER

A growing body of research performed in recent years describes teachers who conduct research concerning their own practice. In the US, such research is called *Practitioner Research*, in England, *Action Research*. Here, I refer to a teacher doing research as a teacher-researcher. The role of teacher-researcher has some typical characteristics: it is performed by in-service teachers, who are involved in some sort of teacher's group---school staff, professional development program, or academic courses. Sometimes it is driven by the teacher's own needs concerning her/his practice, but in other cases it is driven by some main theme which is the focus of the group's leader (usually an academic member). The research is conducted by the teacher in his/her own classroom. It is sometimes aimed at establishing a practical knowledge base, including an attempt to articulate an epistemology of practice that includes experiences with reflective teaching, action research, teacher study groups and teacher narratives (Anderson, 2002; Matz & Page, 2002). The phenomenon of teacher-researcher is widespread, and it is perceived as advancing one's teaching practice. On the other hand, the possible contribution of research conducted by teachers to the knowledge of mathematics education is questionable (Breen, 2003; Labaree, 2003), since such research is preliminarily defined and focused according to the teacher's specific needs, and is therefore bound by them.

On the other hand, there is a trend in cognitive research that involves researchers choosing to go into the practice of teaching in order to conduct their research in a

class that they themselves are teaching. I call these people researcher-teachers. These researcher-teachers are driven by a research question that has evolved from the literature of mathematics education, or their own curiosity, or both. To answer the question, the researcher chooses to be an involved researcher. For example:

- When the purpose of the study is to investigate and expose the considerations and dilemmas involved in teaching in classrooms from the teacher's perspective, the researcher-teacher uses her/his own classroom to conduct the research. Ball (2000) reflects upon her own teaching, to expose the knowledge a mathematics teacher needs to teach in elementary school. She offers an insider's perspective of people who belong to the classroom community.
- Lampert (1990) examines the possibility of teaching mathematics in a manner resembling the way mathematical knowledge is constructed within a community of mathematicians.
- Rosen (in Novotna et al., 2003) uses teaching in his own class as a base for the knowledge he may present to other teachers when he offers alternative teaching methods. Rosen develops his teaching methods in a "real" classroom setting, with all of its inherent complications.

These are some examples of researchers who were motivated by the search for answers to their research questions and chose to be teachers. The focus of these researchers was the teacher and the teaching.

Both terms, teacher-researcher and researcher-teacher, describe one person involved in two domains: research and teaching. The main dilemma occurs in class---how does this one individual react to classroom events in a way that will take into account the researcher's and teacher's agendas?

## **FROM TEACHER TO RESEARCHER-TEACHER---A PERSONAL CASE STUDY**

I am a PhD student in the Department of Science Teaching at the Weizmann Institute of Science, where I completed my Master's thesis while, in parallel, accumulating extensive experience as a mathematics teacher. As such, my professional training includes both teaching and research. In my PhD study I am conducting research in which I define myself as a researcher-teacher. The source of my research work is twofold: the literature, which reports research findings in mathematics education regarding the benefits of initiating the use of computers in the mathematics classroom, and my own curiosity as a teacher about the possibilities of unlimited computer use. My goal is to examine learning in an environment in which a computer is always available, and its use is optional---students can decide if, when and how to work with computers. This has led me (as a researcher with education and experience in teaching) to design an innovative learning environment, and to implement the teaching in this environment for a 2-year period.

I am aware of the dilemma involved in a single person doing both research and teaching. I have tried to separate the roles temporally: the learning environment and

materials were designed before I started teaching, from a researcher's point of view, while bearing in mind the practical aspects of classroom life (duration, difficulty level, applicability, content, etc.). During the school year, teaching in the classroom was done from the teacher's point of view, while keeping an "observer's eye" on things, as is typical for a researcher (keeping a diary of interesting phenomena, documenting classroom work). While I am in classroom, the leading perspective is teaching (although awareness of the research exists). This limits my ability to observe (for practical reasons), which I try to overcome by means of documentation. Reflection after teaching is done from a researcher's point of view: studying events which took place, while watching and listening to recorded data from the classroom. Students' work files are examined after class from a researcher's perspective, bearing in mind that students' needs will determine my course of action as a teacher in the next lesson.

The teacher's role is a demanding one. The teacher's first priorities are responding to students' needs, which are many. In some lessons, I found myself acting as a teacher only, while in others, students functioned in a way that allowed me to observe parts of the events as a researcher. One of the things that helped me keep my "research eye" open was the teaching diary. During about a third of the research period, I sent my diary to my supervisors, after each lesson. Each of them read the diary and sent back questions, remarks, and insights regarding my research and even teaching. Since both are experienced researchers, their attitude towards the episodes I described reflected mainly that perspective. Reading their reactions drew my attention to the research aspects during my work as a teacher. In point of fact, an interested colleague, who offers support and interpretation, is a key factor in the professional development of a teacher (Davis, 1997). The interest, support and interpretation of research experts played a role in shaping my research view of my class.

In the following, I give some examples from my researcher-teacher experience, which demonstrate cases in which a researcher would have investigated more, but my obligations as a teacher towards my students did not allow it, as well as cases in which being an insider (teacher) helped me identify events which called for research.

### **A clash scenario: *M-teacher* disturbs *M-researcher*<sup>1</sup>**

As already mentioned, in the initial stage of the research, *M-researcher* designed the learning environment, including modifications of activities. In one such task, the following question was posed:

In the Excel file p80.xls you will find the following table. Open the file and fill in the table. Write down formulas which you used.

---

<sup>1</sup> I use the term *M-teacher* to describe my perspective as a teacher, and *M-researcher* when I am referring to my perspective as a researcher.

	A	B	C	D
1	The large number	The small number	The difference between A and B	How many times A is greater than B
2	1	$\frac{1}{2}$		
3	1	$\frac{1}{3}$		
4	1	$\frac{2}{5}$		
5	1	$\frac{4}{5}$		

M-researcher, from a designer's perspective, prepared this question to encourage the use of formulas and demonstrate the numerical power of Excel. M-teacher saw that students answered this question using three different tools: some calculated using pencil and paper (or a calculator), some used formulas in Excel, and some answered this question in a Word file. M-teacher was surprised by this third way, and M-researcher was troubled by the thought that students might perceive the computer as one entity, and not distinguish among the different tools---when is it preferable to use Excel? (The lesson took place in the third week of the course.) M-researcher wanted to administer a questionnaire in the next lesson, to ask students how they worked and why they chose that method. M-teacher thought that such a questionnaire was not directly relevant to the learning sequence, but in the end, she administered the questionnaire. M-teacher was surprised to read the students' answers. Only one student reported using Word, while the rest reported manual work or the use of Excel, mentioning the advantage of formulae and the "drag" operation. M-teacher was embarrassed: she had counted 10 students using Word during that lesson. What happened? M-researcher wanted to get to the bottom of this issue, confronting students' files with their questionnaire, but this time M-teacher decided it was sufficient, at this stage, that students could declare the benefits of using Excel. What did M-researcher lose? We cannot say.

### **A clash scenario: *M-researcher* "takes over" *M-teacher* in class**

In the second year, before the opening lesson, *M-researcher* read the diary of the opening lesson from first year. *M-teacher* felt that she was well prepared for this lesson, since she "knew" what was going to happen. I quote from that lesson's diary: "Reading last year's diary was a mistake! It made me expect a certain flow of events, the one that had occurred last year. This expectation led to a 'bumpy' lesson flow, because I was looking for last year's remarks!" *M-teacher* felt that this situation was a result of the "presence" of *M-researcher*.

### **Synergy: *M-teacher* affects *M-researcher*, by identifying a phenomenon for research**

During class work on an activity in which students look for equivalent expressions for a given expression by applying distributive law, *M-teacher* saw that students produced some unexpected expressions. In the diary entry from that lesson, *M-*

*teacher* wrote a remark to *M-researcher*, to examine students' working files closely. *M-teacher* designed a short assessment activity on the same mathematical topic, and administered it to the students. *M-teacher* checked the students' work, and found a wide variety of expressions. As a result, *M-researcher* collected the work done by students from other classes for future research. In the following year, *M-researcher* invited another researcher to observe the activity. More details about this activity and the findings regarding learning algebraic manipulations in an *Excel* environment can be found in Tabach & Freidlander (submitted).

### **Synergy: *M-researcher* affects *M-teacher*, by creating learning opportunities**

In the diary from Oct 1, 2003, before the lesson, *M-teacher* wrote: "The problem I see in the coming lesson is that the activity does not invite students to use *Excel*. It will be interesting to see if students will surprise me once again." The next day, when *M-teacher* arrived at school, she faced a dilemma: to enter the computer laboratory or to stay with her students in the regular classroom, as one of the teachers had asked her to. Here *M-researcher* interfered, and hence *M-teacher* entered the computer laboratory. In that lesson's diary it was written: "To my delight, *M-researcher* took over *M-teacher*, and I did not give up the computer laboratory." During the activity, students used the *Excel* in a variety of original strategies. In this entry I wrote: "I think that the various strategies emerged due to a combination of elements. The activity itself contained no instructions as to how to use *Excel*, yet students already knew what spreadsheets could offer, and the norm of using the computer for their own needs had been established." The learning that took place in that lesson is reported in Tabach, Hershkowitz and Arcavi (in preparation).

## **CONCLUDING REMARKS**

In this report, I have tried to shed some light on issues relating to attempts at being a mathematics teacher and researcher at the same time. I used my own experience to demonstrate a possible way of moving between the two roles. Self-awareness of the role you have taken on at every moment is crucial, even while realizing that sometimes it will not help (see above examples). Note that even in a clash scenario, an awareness of both perspectives enhances and sharpens. The most problematic part of being a teacher and researcher simultaneously arose during the lessons: the teacher's first commitment is to students' needs. Hence, in the classroom, the teacher must act like a teacher, keeping the researcher's voice silent. In analysis, the main perspective should belong to the researcher. An awareness of the opportunities afforded by mixing roles may advance both---teaching and research. Activities such as planning learning sequences or analysing data can be temporally separated from the teaching itself. A teacher who is doing research may become more reflective as a teacher. A researcher who is teaching may change his/her interpretations as a result of the broadening in his/her perspective. More thought is required with respect to possible ways of overcoming the dilemmas involved in being a researcher and teacher simultaneously.

## References

- Anderson, G. L. (2002). Reflecting on research for doctoral students in education. *Educational Research*, 31(7), 22-25.
- Ball, L. D. (2000). Working on the inside: using one's own practice as a site for studying teaching and learning. In A. E. Kelly & R. A. Lesh (Eds.), *Handbook of Research Design in Mathematics and Science Education* (pp. 365-402). Mahwah, NJ: Lawrence Erlbaum Associates, Publishers.
- Breen, C. (2003). Mathematics teacher as researcher: living on the edge? In A. Bishop, K. Clements, C. Keitel & J. Kilpatrick (Eds.), *The Second International Handbook of Mathematics Education*. Dordrecht: Kluwer Academic Publishers.
- Davis, B. (1997). Listening for differences: an evolving conception of mathematics teaching. *Journal of Research in Mathematics Education*, 28, 335-376.
- Hershkowitz, R., Dreyfus, T., Ben-Zvi, D., Friedlander, A., Hadas, N., Resnick, T. & Tabach, M. (2002). Mathematics curriculum development for computerized environments: a designer-researcher-teacher-learner activity. In L. English (Ed.), *Handbook of International Research in Mathematics Education* (pp. 657-694). Mahwah, NJ: Lawrence Erlbaum Associates, Publishers.
- Labaree, F. D. (2003). The peculiar problem of preparing educational researchers. *Educational Researcher*, 32(4), 13-22.
- Lampert, M. (1990). When the problem is not the question and the solution is not the answer: mathematical knowing and teaching. *American Educational Research Journal*, 27(1), 29-63.
- Magidson, S. (2005). Building bridges within mathematics education: teaching, research, and instructional design. *Journal of Mathematical Behavior*, 24(2), 135-169.
- Matz, M. H. & Page, R. N. (2002). The uses of practitioner research and status issues in educational research: reply to Garry Anderson. *Educational Research*, 31(7), 26-27.
- Novotna, J., Lebeth, A., Rosen, G. & Zack, V. (2003). Navigating between theory and practice. Teachers who navigate between their research and their practice. Plenary Panel. In N. A. Pateman, B. J. Doherty & J. Zilliox (Eds.), *Proc. 27th Conf. of the Int. Group for the Psychology of Mathematics Education* (Vol. 1, pp. 69-99). Honolulu, HI: Psychology of Mathematics Education.
- Shulman, S. L. (1986). Those who understand: knowledge growth in teaching. *Educational Researcher*, 15(2), 4-14.
- Tabach, M. & Friedlander, A. (submitted). *Understanding equivalence of algebraic expressions in a spreadsheet-based environment*.



# COMPUTER "KNOWLEDGE" AND STUDENT'S IMAGES OF FIGURES: THE CASE OF DRAGGING

Varda Talmon

Michal Yerushalmy

University of Haifa

*This report address issues related to the conceptualization of dragging in Dynamic Geometry Environments (DGEs). Specifically we will analyze tension present among three components of the interactive diagram: the figure, the figure image, and the computer's recognized figure. Users who attempt to predict the outcome of dragging refer to visually apparent components which are not logically recognized by the software, and they use this image to explain their predictions. They do not distinguish their own figure-image from the figure; moreover, they do not distinguish these two from the computer-recognized figure.*

## VISUALIZING DYNAMIC BEHAVIOR

Geometric figures on the screen (as on paper) have a double nature: they are material entities but they are also theoretical objects. Based on this duality, Laborde (1993) distinguishes the *figure*, the theoretical object, and the *drawing*, one particular material entity. Parzysz (1988) describes the *figure* as "the geometrical object which is described by the text defining it". We shall refer to the *figure* within DGE as an object that includes the construction procedure, the visual outcome, and all the derived geometric properties preserved under dragging. Following Vinner and Hershkowitz's (1980) distinction between the *concept* and the *concept-image*, we use *figure-image* to describe the total cognitive structure that is associated with the *figure*. We refer to *figure-image* as the mental images that the user holds based on previous experience with the *figure* and with dragging. Using DGE necessitates attention to a third type of figure: the *Computer-recognized figure*, which includes the procedure of the construction and additional knowledge that the software designers computed.

## COMPUTER-RECOGNIZED FIGURE

Dragging within DGEs produces a Dynamic Behavior (DB) for each element in the construction. Laborde (1993) argued that DB can assume the role of the written procedure. "The movement produced by the drag mode is the way of externalizing the set of relations defining a figure" (Laborde, 1993, p. 56). A necessary condition for a construction to be correct is being able to produce from it several (or an infinite number of) drawings that preserve the intended properties when variable elements of the figure are modified. This "drag test" becomes a crucial tool in analyzing students' perceptions and creating learning tasks (Holzl, 2001; Jones, 1998; Mariotti, 2002) By Dynamic Behavior we refer to the degree of freedom of the dragged element and the response of the other elements, that is, changes and invariance. For example, dragging point B of the construction in fig. 1 within three different DGEs, The Cabri

2006. In Novotná, J., Moraová, H., Krátká, M. & Stehlíková, N. (Eds.). *Proceedings 30<sup>th</sup> Conference of the International Group for the Psychology of Mathematics Education*, Vol. 5, pp. 241-248. Prague: PME. 5 - 241

II (Baulac, Bellemain, and Laborde, 1994), The Geometer Sketchpad (Jackiw, 1995) and the geometric Supposer (Schwartz, Yerushalmy, and Shternberg, 1998), produces different outcomes (fig. 2).

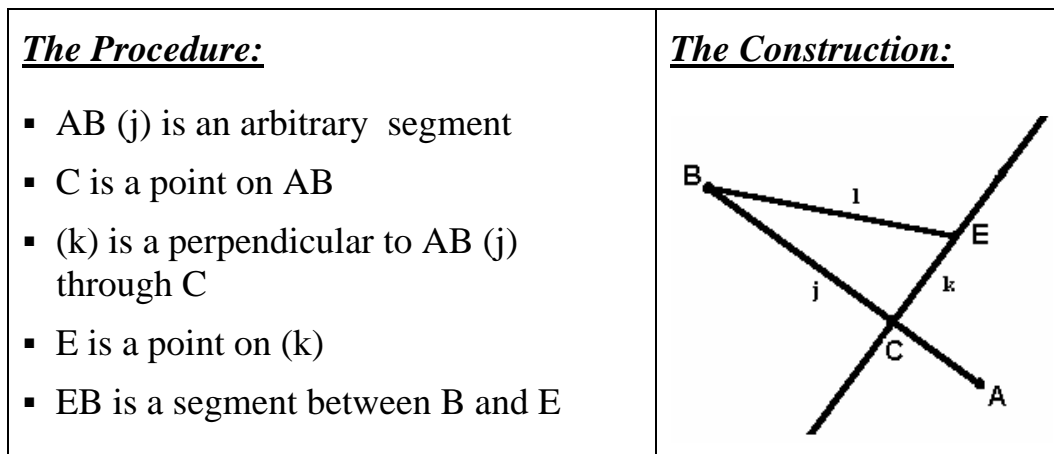

**Fig. 1: The procedure and the construction**

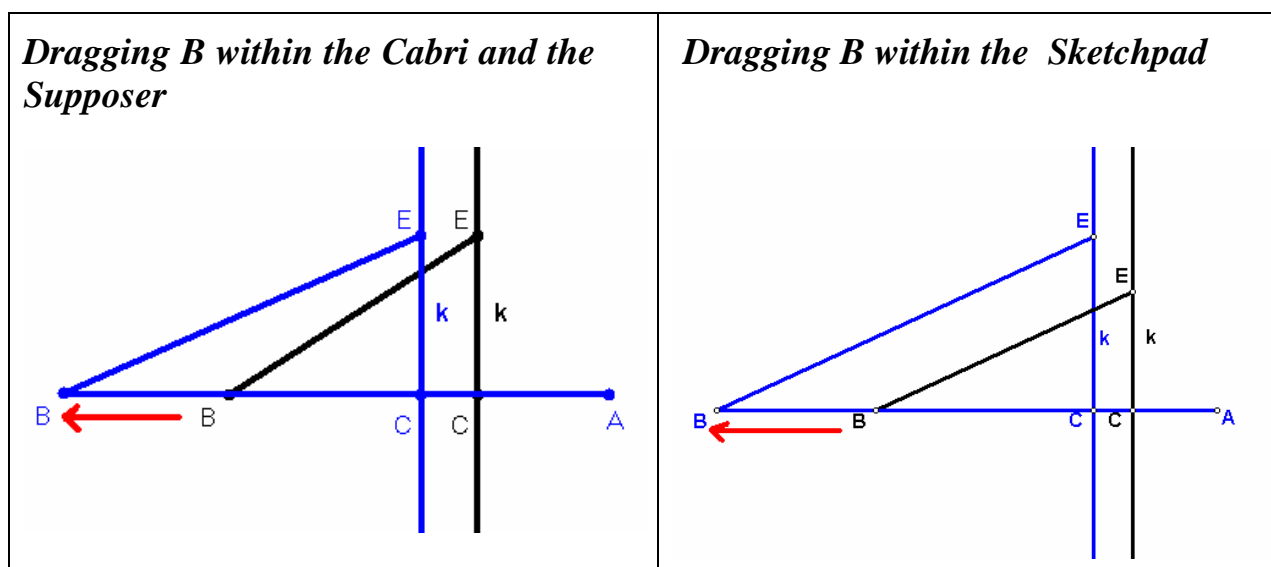

**Fig. 2: Dragging point B within three different DGEs**

Dragging point B affects the location of point E, an arbitrary point on the perpendicular line (k) in the construction (fig. 2). The definition of a point as "on a perpendicular line" says nothing about where on the line the point falls, nor does it presuppose some notion of the "identity" of that point as the line itself translates, rotates, and dilates in the plane. Perhaps the most faithful dynamic representation of such a definition is one in which the point continuously hops about the line, visiting locations on that line chosen at random with uniform probability. None of the three DGEs adopts this last faithful DB. Dragging point B within the Cabri and the Supposer preserves the distance between C and E, while dragging point B in Sketchpad preserves the ratio between EC and BC.

Actually, DB is often an outcome of design considerations that go beyond the logic of geometry and are based on a combination of convenience, immediacy, accessibility, and consistency. In the case of the construction (fig.1) the different DBs have occurred due to two different design decisions: one is to preserve the distance between C and E upon dragging point B, and the other to preserve the ratio between EC and BC upon dragging point B. When Jackiw (personal communication) was asked to explain why the ratio was preserved in the Sketchpad, he answered: “Parallel and perpendicular lines inherit the same metric as the line to which they are parallel or perpendicular. Thus, as a segment stretches under dynamic manipulation, a line constructed perpendicular to it will stretch as well, dilating the distance between any points placed on that line.” Jackiw described the procedure that underlines the construction of an arbitrary point on the perpendicular line as affine transformations consisting of two steps: (1) Construct an arbitrary point on AB; (2) Rotate the point  $90^{\circ}$  around C as a center. In this manner, Jackiw maintained consistency of movement, with dragging preserving the ratios. Such decisions cause the *figure* and the *Computer-recognized figure* to be different entities. The dynamic behavior is an outcome of the *Computer-recognized figure*, not of the *figure*.

We attempt to study the possible impact of such designers' decisions on students' understanding. The present article is a part of a larger study in which we investigate epistemological and cognitive aspects of dragging within DGE. We found that experienced DGE users often predict false DB and that their predictions are frequently characterized by reverse-order perceptions of the hierarchy in the construction (Talmon, and Yerushalmy, 2004). Here our focus is on the complexities involved in understanding Dynamic Behavior. We trace the mental images held by the interviewees and the tendency to relate the *figure-image* (visually apparent figure), which is not logically recognized by the software (*computer-recognized figure*), to the Dynamic Behavior of the *figure*.

## THE RESEARCH DESIGN

The main tool of our experimental study was a task-based interview procedure in which interviewees performed the procedure of the construction shown in Figure 1. Based on the assumption that the ability to predict the resolution of an action is one of the characteristics of concept development (Piaget, 1976), the study explored users' perceptions of DB as expressed in their predictions and explanations of the DB of the figure they had constructed. We interviewed five ninth-grade students and four MathEd graduate students, all experienced users of DGEs. Each interviewee used either the Sketchpad or the Supposer. This sample allowed observation of the utilization schemes of different users with different environments, and the quest for patterns of predictions.

The construction (fig. 1) is simple, short, and easy to do. Still, it presents various non-trivial types of DB. Thus, the simplicity of the construction made it suitable for studying predictions of DB. The procedure was made available throughout the interview so that interviewees did not have to memorize it but could make use of it.

Although the construction procedure was given, it was important that interviewees physically perform the construction so that the *figure* on the screen would not appear to them as a black box. They were not told what shape or *figure* they were constructing, so as to reduce the effect of preconceptions regarding the outcome of their performance.

## FIGURE-IMAGE AND THE CONCEPTUALIZATION OF DRAGGING

The right triangle EBC appeared in many of the interviewees' predictions of dynamic behavior. Apparently this figure-image affected their predictions. In the following dialog, from the interview with Nurit, a MathEd graduate student, who is a math teacher, this figure-image played an important role. In the first part of the interview, she followed the procedure in Fig. 1 and used the Sketchpad.

Interviewer: what did you construct?

Nurit: [I constructed] a right triangle, one of the perpendicular sides of which is a line.

Interviewer: A right triangle?

Nurit: Yes, I constructed a right triangle.

Interviewer: Can you make some conjunctures on that?

Nurit: Besides Pythagoras's theorem? [I can say nothing].

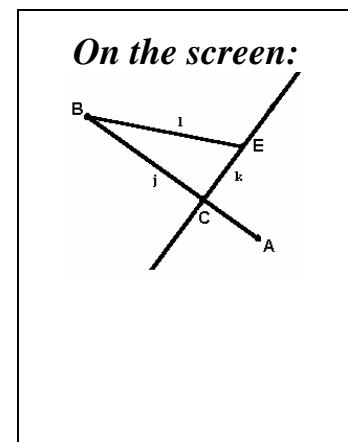

We can learn about Nurit's *figure-image* of a triangle from Nurit explicit answer at the beginning of the interview. When asked what she had constructed, Nurit answered: “A *right triangle*,” and mentioned Pythagoras's theorem, which is connected to a right triangle. From the next excerpt from the interview we learn about the influence of that *figure-image* on Nurit's prediction of the DB. In the third part of the interview Nurit tried to drag the elements of the figure and to explain the DB she saw on the screen:

Nurit: Ah, the angle [EBC] is preserved.

Interviewer: Why?

Nurit: Because we placed point E here [pointing to the location of E on the perpendicular line] and we connected EB so we created an angle that is preserved.

Nurit dragged another element:

Nurit: Well... Now I understand. [Laughing with some embarrassment.] I constructed a right triangle.

She dragged point B and observed:

Nurit: E moves on the perpendicular line...

In other words, the distance between E and C changed and the proportion between EC and BC was preserved. Since Nurit mentioned that she constructed a right triangle, Varda wanted to verify whether Nurit's prediction of the DB of B had to do with the presence of the triangle, so she deleted segment BE and asked Nurit to predict:

Interviewer: Now, can we drag point B?

Nurit: Yes we can.

Interviewer: And what will happen? Will point [E] move on the perpendicular line?

Nurit: No. The distance between E and C will be preserved.

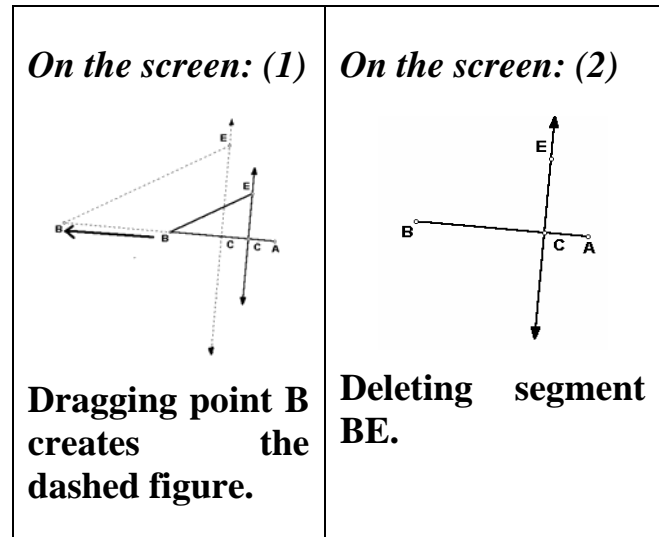

Although she had just seen that the distance between E and C changed when point B was dragged (on screen 1), she predicted that after deleting segment BE (on the screen 2), this distance would be invariant while point B was dragged, meaning that B would have a different DB after BE was constructed.

Varda constructed segment BE again, and asked explicitly:

Interviewer: Is the DB of B different before and after constructing segment BE?

Nurit: Yes, because if there is no triangle, why should it preserve the proportion between the sides of the triangle?

### COMPUTER-RECOGNIZED FIGURE AND THE FIGURE-IMAGE

What can be learned from such examples about understanding of dragging? Certainly, that one has to understand that the on-screen information is not identical to the computer's recognized figure. The on-screen figure represents the constructed procedure and the additional knowledge designed by the designers. Nurit in the example above argues that we constructed a right triangle. Indeed a right triangle always appears in her construction because the construction included perpendicular lines (fig. 3). However, the construction does not include any statement that defines triangle ECB. The software would not provide measurement of ECB, for example! What we found is that Nurit, like other users, predicted and explained dynamic behavior using her figure-image. Nurit argued that the ratio between EC and BC was preserved under dragging because dragging should keep all the triangles similar. When she did not see a triangle (because we erased segment EB) she predicted that the ratio would not be preserved under dragging.

Nurit mistakenly assumed that the DB was derived by the figure-image rather than by the computer-recognized figure, which consists of three components: the construction procedure, the geometry in the construction, and the designer's decisions. The computer-recognized figure does not include a "right triangle" and the preserved ratio is the result of a design decision, as portrayed in fig. 2.

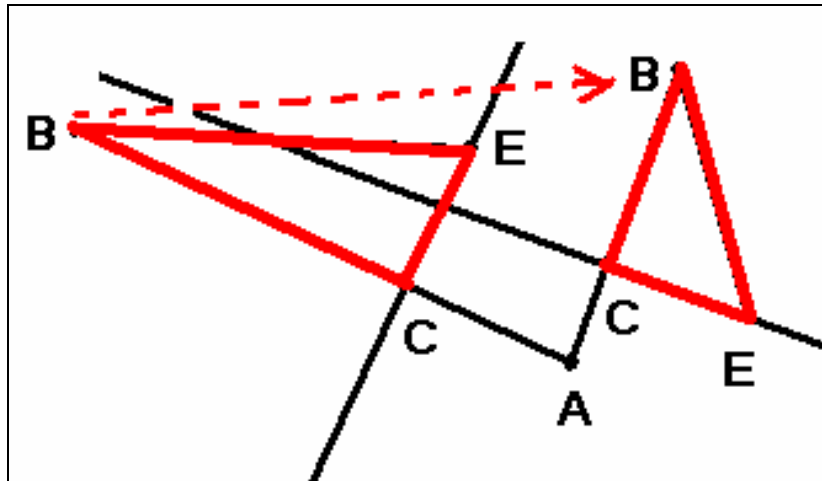

Fig. 3: The right triangle ABC preserved under dragging

The above decision exemplifies a class of design decisions that have important impact on users' prediction of dragging. We find such decisions even in what seems to be a basic design consideration – for example in the mechanisms of the construction of intersection points. In the case of two intersecting segments dragging can turn to be non-intersecting segments. The originally defined intersection point may disappear or remains as a virtual point. Indeed within the Cabri and the Sketchpad the point disappears and within the Supposer it remains as the point of intersection of the two lines those segments could be part of.

When the three DGEs deal with intersection of a circle and a line through a given point on the circle (C) the decisions are as follows (fig. 4): The Supposer and the Sketchpad provides two new intersection points on the circle (although one point coincides with the given point) but each design assumes a different DB to the two intersection points. The Cabri developers granted to the computer the "knowledge" that two points coincide and thus only add a single new intersection point.

We suggest that such examples should lead educators to further question what is a point in dynamic environment. Is it that the point already exists on the screen and construction means labeling existing point or is "labeling" the act of "constructing" the point? Thus, the design decision regarding the existence of a point is not a technical matter but rather philosophical which probably carries cognitive implications.

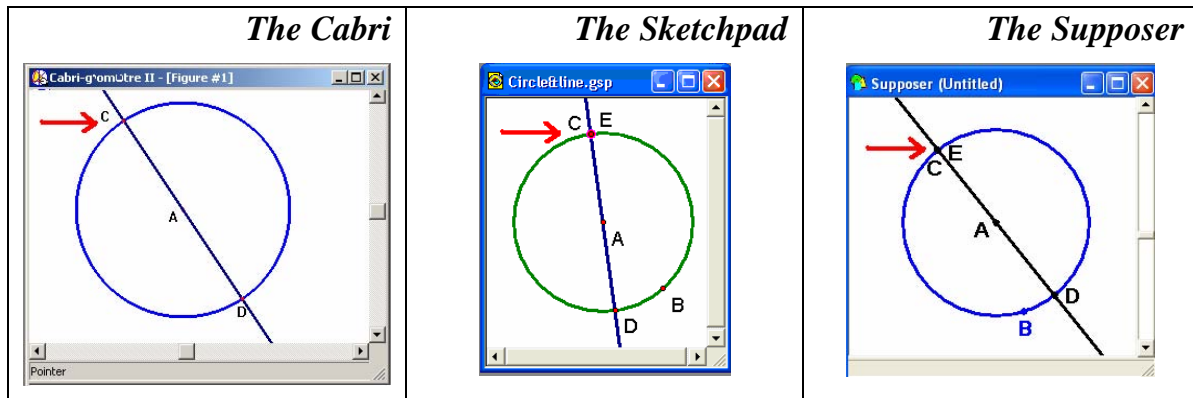

Fig. 4: intersection of a circle and a line through a given point on the circle

## CONCLUDING REMARKS

The longer various DGEs are in use and under study, the more we learn about their contribution to the learning of geometry and about new complexities that are likely to appear in such learning. The complexity we presented in this article has to do first with the gap between figure and figure-image, and second with the gap between figure, figure-image, and computer-recognized figure. While the former is not surprising, and is actually consistent with Hershkowitz's (1989) finding regarding the dominance of image over a given definition, the latter suggests that dragging is by no means a transparent tool even for experienced users.

We suggest that these findings could contribute to crystallize and deepen further research questions, as well as curriculum and software design considerations, and make the tool both visible and invisible as Lave and Wenger (1991) argue: visible, to enable users to see its special properties, and invisible, to enable users to see the geometry properties of the dragged object. It is suggested that for better understanding of the complexity of DB within DGE, software design decisions should be further investigated, and guided by such questions as: What do users observe while dragging one element of the construction? How do they interpret DB? What are their perceptions of it? And what decisions made by the designers influence the DB of a figure?

## References

- Baulac, Y., Bellemain, F., & Laborde, J.-M. (1994). *Cabri II* [software]. Dallas, TX: Texas Instruments.
- Hershkowitz, R. (1989). Visualization in Geometry - Two Sides of the Coin. *Focus on Learning Problems in Mathematics*, 11, 61-75.
- Holzl, R. (2001). Using Dynamic Geometry Software to Add Contrast to Geometric Situation - A Case of Study. *International Journal of Computers for Mathematical Learning*, 6, 63-86.
- Jackiw, N. (1995). *The Geometer's Sketchpad III* [software]. Berkeley, CA: Key Curriculum Press.

- Jones, K. (1998). The Mediation of Learning within a Dynamic Geometry Environment. In A. Olivier & K. Newstead (Eds.), *Proc. 22<sup>nd</sup> Conf. of the Int. Group for the Psychology of Mathematics Education*, (Vol. 3, pp. 96-103). Stellenbosch, South Africa.
- Laborde, C. (1993). The Computer as Part of the Learning Environment: The Case of Geometry. In C. Keitel & K. Ruthven (Eds.), *Learning from Computers: Mathematics Education and Technology*, vol. 121 (pp. 48-67). Berlin and Heidelberg: NATO ASI Series, Springer-Verlag.
- Lave, J., & Wenger, E. (1991). *Situated Learning, Legitimate Peripheral Participation*. U.K.: Cambridge University Press.
- Mariotti, M. A. (2002). The Influence of Technological Advances on Students' Mathematics Learning .In L. D. English (Ed.), *Handbook of International Research in Mathematics Education*. (pp. 695-723). Mahwah, NJ: Erlbaum.
- Parzysz, B. (1988). "Knowing" vs. "Seeing": Problems of the Plane Representation of Space Geometry Figures. *Educational Studies in Mathematics*, 19, 79-92.
- Piaget, J. (1976). *The Grasp of Consciousness* (S. Wedgwood, Trans.): Cambridge, Massachusetts: Harvard University Press (original work published in 1974).
- Schwartz, J. L., Yerushalmy, M., & Shternberg, B. (1998). *The Geometric Supposer (for Windows)* [software]. Tel Aviv, Israel: The Center for Educational Technology.
- Talmon, V., & Yerushalmy, M. (2004). Understanding Dynamic Behavior: Parent-Child Relations in Dynamic Geometry Environments. *Educational Studies in Mathematics*, 57, 91-119.
- Vinner, S., & Hershkowitz, R. (1980). Concept Images and Common Cognitive Paths in the Development of Some Simple Geometric Concepts. *Proc. 4th Conf. of the Int. Group for the Psychology of Mathematics Education*, (Vol. 3, pp. 209-216.) Berkeley, California.



# GRAPHICS CALCULATORS FOR MATHEMATICS LEARNING IN SINGAPORE AND VICTORIA (AUSTRALIA): TEACHERS' VIEWS

Hazel Tan & Helen J. Forgasz

Monash University

*In this paper, findings from a study in which Singaporean and Victorian (Australia) mathematics teachers' views on the use of graphics calculators for mathematics learning were compared. The results indicated that Victorian teachers were more enthusiastic about graphics calculators than Singaporean teachers. It was speculated that one of the main reasons for the differences in the teachers' views stemmed from the fact that graphics calculators are mandated for grade 12 examinations in Victoria while this is not the case in Singapore.*

## BACKGROUND TO THE STUDY

Graphics calculators first appeared in 1985 (Kissane, 1995). Since then, their use has been included in the mathematics curricula of several countries. According to Waits and Demana (1994), the US National Council of Teachers of Mathematics [NCTM] *Curriculum and Evaluation Standards* for grades 9-12 included the assumption that graphics calculators would be available to all students at all times. Various European countries and some Australian states have similar policy expectations (e.g., Brown, 1999).

As the use of graphics calculators becomes more widespread, it is important to expand beyond studying the effects of calculators on students' learning. In this study, senior secondary mathematics teachers' views on graphics calculators in two regions, Singapore and Victoria (Australia), were compared.

## GRAPHICS CALCULATOR POLICIES IN SINGAPORE AND VICTORIA

In 1997, Victoria was the first state in Australia to adopt the use of graphics calculators in grade 12 Victorian Certificate of Education [VCE] external examinations (Brown, 1999; VCAA, 2003). Graphics calculators had been introduced in two stages: a *neutral* format in which students without calculators were not disadvantaged, and *assumed access* in which all students were expected to have access to graphics calculators (Stacey, McCrae, Chick, Asp & Leigh-Lancaster, 2000; VCAA, 2003).

Since 2002, only a small group of mathematically inclined students taking the subject Further Mathematics at the senior secondary levels in Singapore were allowed to use graphics calculators in their examinations (Lee, 2005). The majority of students studied the subject Mathematics, and graphics calculators were not allowed in the

examinations. Graphics calculators will be introduced more widely into the revised mathematics curriculum at the senior secondary level (Junior College Years 1 and 2) in 2006 (Ministry of Education Singapore, 2005).

## **OBJECTIVES OF THE STUDY**

In this paper, findings are reported from a larger study involving the comparison of Singaporean and Victorian teachers' perceptions towards computers and graphics calculators (Tan, 2005). The objectives of the study included comparisons of how graphics calculators were used in the two regions, and of teachers' beliefs about the usefulness of graphics calculators for mathematics learning.

## **PREVIOUS RESEARCH**

Previous research findings suggest that teachers' educational beliefs shape their lesson planning, instructional decisions, and classroom practices (e.g., Pajares, 1992). In their review of 14 research studies on graphics calculators, Burrill et al. (2002) found that "teachers generally use handheld graphic technology as an extension of the way in which they have always taught" (p. iv), and that their knowledge, beliefs and personal philosophies influenced how they used calculators in their teaching.

### **Singaporean teachers' use and views of graphics calculators**

Possibly due to the recency of the introduction of graphics calculators, there is not much research about their use by Singaporean teachers. It is not generally known how widespread the use of graphics calculators is in Singapore.

Lam and Kho (2002) noted that junior college mathematics teachers were concerned about changes in the types of examination questions if graphics calculators were permitted, and the impact that these changes would have on teaching and learning. In a pilot study on the use of computer algebra system (CAS) calculators with two classes of secondary school students in Singapore, Ng (2003) found no significant achievement differences between students who used and those who did not use the calculators. It was also found that the teacher who taught the non-CAS-based lessons conducted extra lessons between class tests and, according to the Head of Department, might have been trying to "counteract the effect of the intervention" (Ng, 2003, p.242) by setting difficult questions which, it was found, the non-CAS students tended to be able to handle better. While not generalisable, the findings of the two studies reveal some beliefs and reservations Singaporean teachers have with introducing new technology into the classroom.

### **Victorian teachers' use and views of graphics calculators**

When graphics calculators were introduced into the VCE examinations in 1997, the Victorian Board of Studies supported a state-wide research study to assess the impact of graphics calculators in schools. In a report of the findings, Routitsky and Tobin (2001) reported that a majority (77.6%) of the 1071 mathematics teachers surveyed

indicated that they had used graphics calculators in their classrooms. It was also reported that teachers were generally supportive of the Board's policy to introduce graphics calculators in assessment. When they disagreed, their disagreement was strongly associated with limited graphics calculator access in the classroom for students or teachers. These findings suggested that access to graphics calculators and teachers' support for graphics calculators are strongly influenced by assessment policy.

Kissane (2000) suggested that in Australia graphics calculators were widely available and were used by students in states which allowed or mandated their use in formal assessment, and were rarely used in those states which did not.

## **METHODOLOGY**

The sample of senior mathematics teachers in this study included those teaching Years 1 and 2 in junior colleges in Singapore, and grades 11 and 12 in independent (non-government, non-Catholic) schools in Victoria. Singapore's two years of junior college and grades 11 and 12 in Victoria are similar in that they comprise the final years of schooling leading to university entrance. Five junior colleges out of 15 in Singapore and 14 out of 116 independent schools in Victoria participated. Mathematics teachers from participating schools completed an anonymous survey on their use and views of technology, including graphics calculators.

The survey instrument was designed based on instruments from past research studies on teachers' use and beliefs of technology (e.g., Becker & Anderson, 1998; Fogarty et al. 2001; Forgasz, 2002; Lim et al., 2003; Tobin, Routitsky, and Jones, 1999). A five-point Likert-type response format was used wherever possible. Examples of items are found in the discussion section of this paper.

## **ANALYSES OF RESULTS AND FINDINGS**

### **Profile of teachers**

Thirty-three teachers (16M, 16F, 1?) from five junior colleges in Singapore and 35 teachers (19M, 16F) from 14 independent schools in Victoria participated in the study. The Singaporean teachers were generally younger than the Victorian teachers. Most (n=22, 71%) of the Singaporean teachers were less than 40 years old, with 14 (45.2%) of them between 30 and 39 years old. In contrast, most (n=25, 71.4%) of the Victorian teachers were at least 40 years old, with 16 (45.7%) between 40 and 45 years old.

### **Number of years of graphics calculator use for mathematics teaching**

Teachers were asked to indicate the number of years they had used graphics calculators for teaching mathematics. The data revealed that a higher proportion of Victorian than Singaporean teachers had used graphics calculators for a long time.

Almost half of the Singaporean teachers (15 out of 31, 48.4%) had not used graphics calculators or had only used them for less than a year, whereas all of the Victorian teachers (N=35) had used graphics calculators in their teaching for some years.

### **Teachers' access to graphics calculators**

A majority of the Singaporean teachers (n=24, 72.7%) had personal access to graphics calculators. In Victoria, all 35 teachers had personal access to graphics calculators, sometimes more than one type of graphics calculator and/or calculators with Computer Algebra System (CAS).

### **Teachers' graphics calculator skills**

When asked to rate their current level of graphics calculator skills, using three categories (Beginner/ Average/ Advanced), Victorian teachers' perceptions of their skills were much higher than those of the Singaporean teachers. More than half the Singaporean teachers (n=19, 57.6%) claimed to be at Beginner level, and only two teachers (6.1%) at the Advanced level. In contrast, only one Victorian teacher (2.9%) indicated being at Beginner level, with more than half of the Victorian teachers (n=18, 51.4%) claiming to be at the Advanced level. This difference in perceived competency resonated with other findings from the study which showed that a higher proportion of Victorian than Singaporean teachers had personal access to graphics calculators and had used them for a long time.

### **How are graphics calculators used in the two regions?**

Survey question 3.3 asked teachers to indicate their frequencies of technology use in 13 different teaching modes, ranging from teacher demonstration to cooperative learning. The frequencies were recorded as follows: 1=not used, 2=once in 6 months, 3=once in 3 months, 4=once in a month, 5=once a week, and 6=more than once a week. To simplify comparisons, the responses were re-coded into "Used" (Responses 2 to 6) and "Not Used" (Response 1) for each teaching mode. Figure 1 shows the valid percentages of teachers who indicated having used calculators for each teaching mode.

From Figure 1 it can be seen that except for using calculators "as a reward" (3.3e), higher proportions of Victorian than Singaporean teachers had used graphics calculators in the remaining 12 teaching modes. It can also be seen that more than 90% of the Victorian teachers had used graphics calculators for: teacher demonstration (3.3a), students working individually (3.3c), students checking their working and answers (3.3h), students doing more challenging questions (3.3i), and as a problem-solving or decision making tool (3.3k). Fewer than 50% of the Victorian teachers had used graphics calculators for: cooperative learning (3.3d), as a reward (3.3e), and as a classroom presentation tool by students (3.3m).

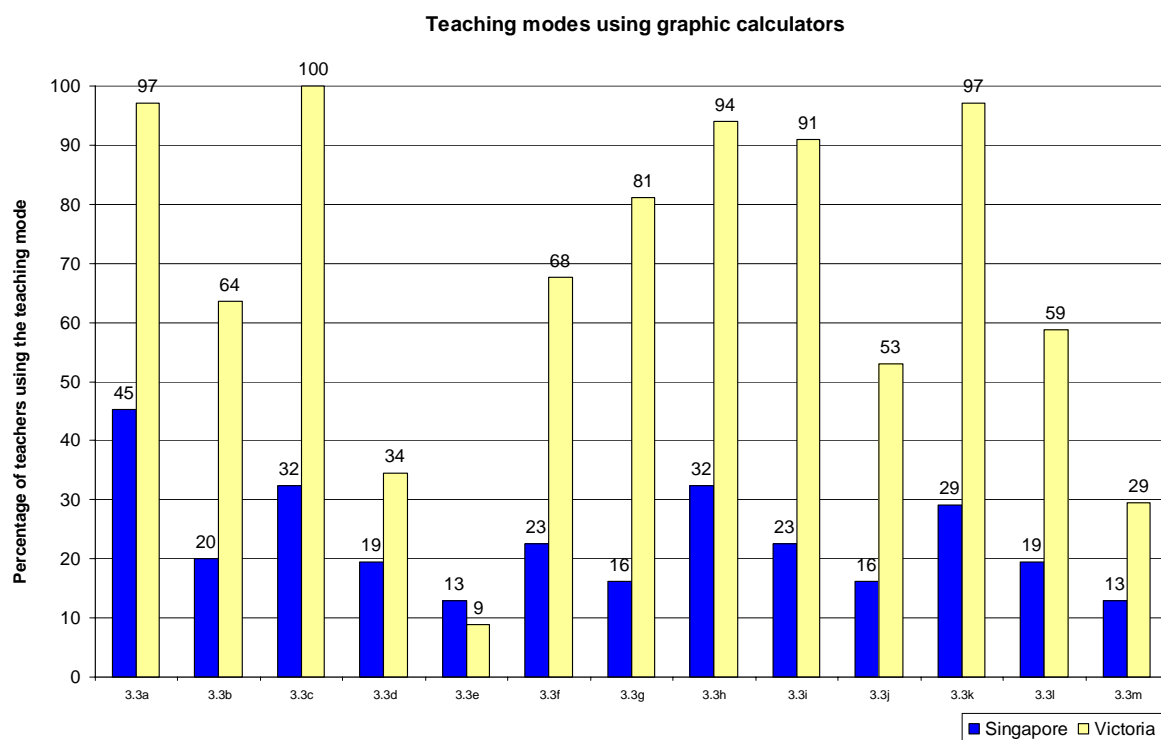

#### Teaching modes:

- 3.3a Teacher demonstrations/lectures**
- 3.3b Students work in small groups**
- 3.3c Students work individually**
- 3.3d Cooperative learning**
- 3.3e As a reward for students**
- 3.3f Individual instruction for weaker students**
- 3.3g Individual instruction for better students**
- 3.3h Students use graphics calculators to check their working and answers**
- 3.3i Students use graphics calculators to do more challenging questions**
- 3.3j Students use graphics calculators as a research tool**

**Figure 1. Percentages of teachers using graphics calculators in various teaching modes.**

As discussed earlier, graphics calculator use is mandated in the VCE examinations. This could explain why there were exceptionally high proportions of Victorian teachers (more than 90%) using graphics calculators in the five ways listed above. These modes of teaching appear to be examination-focused, since students taking VCE examinations have to work individually to solve difficult and challenging mathematics problems using graphics calculators. Interestingly, the three teaching modes that were used by fewer than 50% of the Victorian teachers appear to be non-examination related.

Fewer than 50% of the Singaporean teachers indicated using graphics calculators for each teaching mode. This finding is consistent with Singaporean teachers having only used graphics calculators for a short time and as being novice users of the tool.

### Singaporean and Victorian teachers' views towards the usefulness of graphics calculators for learning Mathematics

Question 1.21 of the survey asked teachers if they believed that using graphics calculators helped their students understand mathematics better (Yes / No / Unsure) and to explain their responses. The percentages of responses for the Singaporean and Victorian teachers are shown in Figure 2.

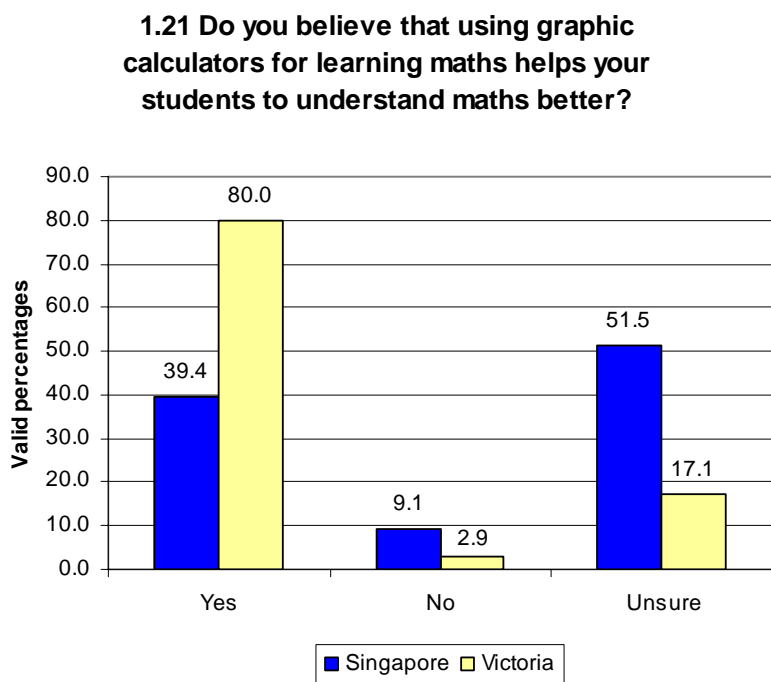

Figure 2. Teachers' beliefs of the usefulness of graphics calculators

It can be seen in Figure 2 that a much higher proportion of Victorian (n=28, 80%) than Singaporean (n=13, 39.4%) teachers agreed that graphics calculators helped students understand mathematics better. The most frequent reasons they provided in support of their views related to the usefulness of graphics calculators in providing graphical representations, saving time from tedious calculations and sketching, allowing students to explore mathematical properties, motivating students, and aiding investigations and explorations by students.

The Singaporean teachers were generally more uncertain about the usefulness of graphics calculators (n=17, 51.5%) than were Victorian teachers (n=6, 17.1%). A few Singaporean teachers explained that they were unsure because they “have yet to use it” and had “no basis for drawing conclusions”. These findings are consistent with other findings reported by the Singaporean teachers’: their low usage of graphics calculators (48.5% of teachers had not used them), and low graphics calculator skill levels (57.6% at beginner level).

## CONCLUSIONS

The small sample sizes limit the generalisability of the findings. Thus only the trends or general directions in which the Singaporean and Victorian mathematics teachers differed or concurred in their use of and views about graphics calculators are commented on. Nevertheless, it was clear from the data that the use of graphics calculators was pervasive in Victoria where their use is mandated, and that the Victorian mathematics teachers were more enthusiastic about them, and used them more frequently and in more varied ways than the Singaporean teachers.

The data from this study strongly suggest that there is a relationship between national or state assessment policy and teachers' use and views of graphics calculators; it will be interesting to see if Singaporean teachers' views change in response to the broader use of graphics calculators associated with changes to the senior mathematics curriculum in 2006. Further research is needed to identify more clearly the relationships between assessment, pedagogical uses of technology, and teachers' beliefs about the usefulness of technology.

## References

- Becker, H. J. H. J., & Anderson, R. E. (1998). *Teaching learning, and computing: 1998 – A national survey of schools and teachers describing their best practices, teaching philosophies, and uses of technology, teacher's survey*. Retrieved May 12, 2004 from: [http://www.crito.uci.edu/tlc/html/tlc\\_home.html](http://www.crito.uci.edu/tlc/html/tlc_home.html)
- Brown, R. (1999). Graphical calculator assessment in Australia: A comparison with other countries. *Proceedings of the fourth International Conference on Technology in Mathematics Teaching (ICTMT4) Plymouth, August 9-13*. Retrieved June 1, 2005 from: [http://www.tech.plym.ac.uk/maths/CTMHOME/ictmt4/P05\\_Brow.pdf](http://www.tech.plym.ac.uk/maths/CTMHOME/ictmt4/P05_Brow.pdf)
- Burrill, G., Allison, J., Breaux, G., Kastberg, S., Leatham, K., & Sanchez, W. (2002). *Handheld graphing technology in secondary mathematics: Research findings and implications for classroom practice*. Report prepared through a grant to Michigan State University. Dallas, TX: Texas Instruments.
- Fogarty, G., Cretchley, P., Harman, C., Ellerton, N., & Konki, N. (2001). Validation of a questionnaire to measure mathematics confidence, computer confidence, and attitudes towards the use of technology for learning mathematics. *Mathematics Education Research Journal*, 13 (2), 154-160.
- Forgasz, H. J. (2002). Teachers and computers for secondary mathematics. *Education and Information Technologies*, 7(2), 111-125.
- Kissane, B. (1995). *Graphics calculators in upper secondary courses*. Retrieved April 2, 2005 from: <http://wwwstaff.murdoch.edu.au/~kissane/SEApaper.html>
- Kissane, B. (2000). Technology and the curriculum: The case of the graphics calculator. In M. O. J. Thomas (Ed.), *Proceedings of TIME 2000: An international conference on Technology In Mathematics Education (pp. 60-71)*. Auckland, New Zealand.
- Lam, Y. -P. & Kho, Y. T. (2002). The impact of the use of graphics calculators for the GCE "A" Level statistical questions in Singapore. In C. Vale, J. Roumeliotis, & J. Horwood

- (Eds.), *Valuing mathematics in society* (pp. 412-424). Brunswick, Australia: Mathematical Association of Victoria.
- Lim, C. P., Khine, M. S., Hew, T., Wong, P., Shanti, D. & Lim, B. (2003). Exploring critical aspects of information technologies integration in Singapore schools. *Australian Journal of Educational Technology*, 19(1), 1-24. Retrieved May 16, 2005, from <http://www.ascilite.org.au/ajet/ajet19/lim.html>
- Ministry of Education, Singapore (2005, May). *Breadth and flexibility: The new 'A' level curriculum 2006*. Retrieved June 4, 2005 from: <http://www.moe.gov.sg/cpdd/alevel2006/>
- Ng, W. L. (2003). Effects of computer algebra system on secondary students' achievement in mathematics: a pilot study in Singapore. *The International Journal of Computer Algebra in Mathematics Education*, 10(4), 235-250.
- Pajares, M. F. (1992). Teachers' beliefs and educational research: Cleaning up a messy construct, *Review of Educational Research*, 62(3), 307-332.
- Tobin, P., Routitsky, A. & Jones, P. (1999). Graphics calculators in Victorian secondary schools: Teacher perceptions of use. In J. M. Truran & K. M. Truran (Eds.), *Making the difference*. Proceedings of the 22<sup>nd</sup> annual conference of the Mathematics Education Research Group of Australasia (pp. 502-506). Sydney, NSW: MERGA Inc.
- Victorian Curriculum and Assessment Authority [VCAA]. (2003, December). Consultation paper for VCE mathematics examinations: 2006 and beyond. *VCE bulletin supplement 2*, 1-12. Retrieved April 9, 2005 from: <http://www.vcaa.vic.edu.au/vce/studies/mathematics/caspilot/casindex.html>
- Waits, B. K. & Demana, F. (1994). The calculator and computer precalculus project (C<sup>2</sup>PC): What have we learned in ten years? In G. Bright (Ed). *Impact of calculators on mathematics instruction*. Lanham, MD: University Press of America, Inc. Retrieved May 20, 2004 from: <http://www.math.ohio-state.edu/~waitsb/papers/c2pc10y.pdf>



# VAGUE LANGUAGE IN GREEK AND ENGLISH MATHEMATICAL TALK: A VARIATION STUDY IN FACE-WORK

Konstantinos Tatsis

University of Ioannina, Greece

Tim Rowland

University of Cambridge, UK

*In this paper we consider data selected from two larger studies of mathematical discourse, one in the Greek language, the other in English. The analysis focuses on participants' 'face-work' in the cause of 'politeness' i.e. efforts to sustain the autonomy and well-being of themselves and other participants. We examine the application of politeness theory (Brown & Levinson, 1987) in two differently 'politeness-oriented' cultures. Our analysis shows that speakers in both countries respect and try to preserve their hearer's face, and that mathematical talk in both cultures deploys vague language in similar ways. The Greek case demonstrates that, under certain circumstances, the speaker may choose to threaten his/her partner's face in order to maintain his/her own face.*

## INTRODUCTION

The fact that everyday and mathematical language are interwoven in mathematical discussions (Pirie, 1998; Moschkovich, 2003) has led a number of researchers to adopt linguistic methods of analysis in order to clarify a number of issues concerning the teaching and learning of mathematics. Currently, among the various linguistic analyses in mathematics education we can see a trend towards a view according to which language is a means through which the speakers *perform* specific acts. Speech act theory (Austin, 1962; Searle, 1969) stresses the fact that language is – or can be – used to convey more than a single message. Consider, for example, the following sentence produced by a 14-year-old student, Allan (Rowland, 2000, p. 1):

The maximum will probably be, er, the least 'll probably be 'bout fifteen.

The above sentence was a reply to the teacher's request to make a prediction about the number of line-segments between points on a square-dot grid. If we isolate the 'mathematical' message included we end up with the proposition:

There are fifteen segments.

However, Allan's utterance communicates more than the propositional content of its message. Stubbs (1986) claims that every (spoken) sentence encodes a point of view. In particular, we may infer something about his *propositional attitude* (Jaszczolt, 2000) – that he expresses uncertainty. On the other hand, one might ask why Allan didn't simply reply that he lacked confidence in his prediction. These issues that come up from a single utterance – or a single exchange to be precise – demonstrate the richness of the meanings included in mathematical discussions; on the one hand there are the overtly 'mathematical' meanings, and on the other hand the personal and interpersonal meanings, related to speakers' communicative and personal attitudes. In this connection, Brown and Yule (1983, pp. 1-4) refer to the 'transactional' and

'interactional' functions of language, a distinction which relates to that between semantic and pragmatic meaning. These meanings are continuously interrelated to produce mathematical discourse. Analyses of mathematical discourse that take account of both kinds of meaning include those of Bills (2000), Rowland (1997) and Wagner (2003). One issue raised by such analyses is whether the linguistic strategies described can be found in different cultural settings. In English, for example, the utterance "I don't suppose I could possibly ask you to bring back a newspaper" is an indirect speech act – a polite request – but in Greek it is not a request at all. This issue led us to the formation of a variation analysis, between cases from two different cultures: the English and the Greek. Before we proceed with the analysis itself we shall present our basic theoretical framework, i.e. politeness theory.

## POLITENESS THEORY

Politeness theory (Brown and Levinson, 1987) is a sociolinguistic theory based on Goffman's (1972) notion of 'face' i.e. "the positive social value a person effectively claims for himself by the line others assume he has taken during a particular contact" (p. 5). Face is categorised into positive and negative: positive face is related to a person's need for social approval, whereas negative face is related to a person's need for freedom of action. The Model Person (MP) of the theory not only has these wants her/himself, but recognises that others have them too; moreover, s/he recognises that the satisfaction of her/his own face wants is, in part, achieved by the acknowledgement of those of others. Indeed, the nature of positive face wants is such that they can only be satisfied by the attitudes of others.

Now some acts ('face threatening acts', or FTAs) intrinsically threaten face. Orders and requests, for example, threaten negative face, whereas criticism and disagreement threaten positive face. The MP therefore must avoid such acts altogether (which may be impossible for a host of reasons, including concern for her/his own face) or find ways of performing them whilst mitigating their FTA effect, i.e. making them less of a threat. Imagine, for example, that someone says something that MP believes to be factually incorrect; MP would like to correct him/her. Such an act would threaten the first speaker's positive face – the esteem in which s/he is held as a purveyor of knowledge. Or suppose that MP would like someone to open the window, but is aware of the threat to the other's negative face. Brown and Levinson identify a taxonomy of strategies available to MP in such circumstances, *viz.*

- 1 Don't do the FTA – simply agree or keep quiet.
- 2 Do the FTA: in which case there is a further choice of strategy:
  - 2.1 Go off record – don't do the FTA directly, but implicate it e.g. "Don't you think it's hot in here?" (indirect request to open a window).
  - 2.2 Go on record: either
    - 2.2.1 'baldly' – essentially making no attempt to respect face; *or*
    - 2.2.2 with redressive action: having regard either for the other's -
      - 2.2.2.1 positive face ("You're the expert in these matters, but I thought that ..."); *or*
      - 2.2.2.2 negative face ("I'm sorry to trouble you, but would you mind ...")

Redressive action – ‘face-work’ – is very commonplace when FTAs are in prospect; such action is a way of indicating that no face threat is intended. Face-work typically deploys various forms of indirect and vague language. Hedges i.e. “words whose job is to make things fuzzier or less fuzzy” (Lakoff, 1973, p. 490) are a form of vague language; modality is used to convey the speaker’s propositional attitude, which may vary from confidence to doubt. Allan’s quote, for example, includes one hedge – ‘probably’ – reinforced by another – ‘(a)bout’. ‘Probably’ is a let-out for him, for it makes his lack of commitment explicit, redressing the threat to his positive face. The use of the approximator ‘about’ is a more subtle protective strategy, for it “trivialises the semantics” of the sentence, and thereby renders it “almost unfalsifiable” (Sadock, 1977, p. 437).

While attempting to analyse an instance of communication (e.g. a transcribed discussion) one needs a theoretical foundation to guide analysis, and also a concrete methodology for analysing the verbal data. Conversation analysis (CA) provides a framework for the analysis of utterances produced in a particular context; more than that, context is not treated as a static property of the situation, but as an entity which is continuously re-shaped by the on-going discourse (Heritage, 1984). CA looks for patterns in discourse in order to examine features such as turn-taking and ‘adjacency pairs’, distinguishing between preferred and dispreferred responses to initiating remarks, such as agreement and disagreement (Schiffrin, 1994, pp. 232-281). This is particularly useful in mathematical talk, where concepts and procedures are continuously introduced and negotiated. In the next two sections we shall demonstrate how politeness theory enhanced by conversation analysis may be used to analyse and compare the features of mathematical discussions in two cultures: English and Greek. The text fragments in both cases are necessarily brief.

## THE GREEK CASE

The 40 participants in the study reported here were undergraduate students aged from 20 to 22. Each student was asked to choose a partner, and one problem was assigned for each pair in each of three sessions. Some findings of the study concerning shared mathematical knowledge were reported at an earlier PME meeting (Tatsis and Koleza, 2004); here, we shall examine the different politeness strategies deployed by one pair of Greek students.

The dialogue that follows is translated from Greek and refers to the ‘fish tank problem’, which was given at the third session:

George and Phil were playing with their fish tank. The fish tank is 100 cm long, 60 cm wide and 40 cm high. They tilted the tank, as shown, resting on a 60 cm edge, with the water level reaching the midpoint of the base.

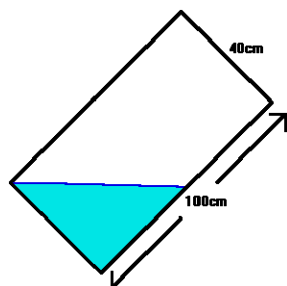

When they rest the tank in a horizontal position, what is the depth of the water in cm?

The following excerpt comes from the beginning phase of the encounter, when the students have not yet clarified the process to be followed. The first author was the observer/researcher.

- 68 Paul Where is it exactly, where will it go? [Paul is referring to the water] It'll go someplace here, it may go to 20, it may go here, anywhere... Does it have to do with triangles?
- 69 Jina The only triangle is the one we've found.
- 70 Paul Triangle, trapezium, whatever it is ... Is this a random point, or is it exactly in the middle? [Paul is asking the observer]
- 71 Observer It's in the middle.
- 72 Paul So, logically, it should be under 20. Cause when it's 40, and what I'm doing seems too practical, it's 50. So, when it reaches 20, it's half, it goes to 100, it'll be like that ...
- 73 Jina Good, we take it like that.
- 74 Paul So, it's 10.
- 75 Jina Why 10?
- 76 Paul Eh, if it is ... Using the same logic since 40 50 ...
- 77 Jina Yes, with ...
- 78 Paul 20 100. It has to be 10 so the ... horizontal. The tank cannot be horizontal and the water stand like that. Is it possible for the water to be like that?
- 79 Jina Yeah, OK. But we still don't use the 60 ...
- 80 Paul So, if you take it ... First, these two axes, look: the one is 40, BC is 50, so when it goes to 20, it'll go to 100. Or when it goes to zero here, it'll go to ... where will it go?
- 81 Jina Here.
- 82 Paul No, if it goes down ...
- 83 Jina What if it's somewhere between 10 and 20?

What is evident throughout the particular excerpt is the students' attempt to reach an agreed solution to the problem; Paul, by using some sort of analogies proposes that the depth of the water must be 10cm, while Jina [75] asks for explanation, perhaps because her partner's thought does not seem justified in a 'mathematical' manner. Indeed, Paul himself [72] asserts that his rationale is "too practical". Initially, while he is trying to organise his thinking, he hedges his language: [68] "It'll go *someplace* here, it *may* go to 20, it *may* go here, *anywhere*...". This is a characteristic case of the use of vague language when a speaker lacks information, in order to protect his/her positive face. Gradually, Paul is led to the conclusion that the height of the water must be less than 20cm [72]; he realises that his justification is not 'mathematical' but 'practical', and his use of the modal 'should' conveys his propositional attitude – possibility rather than certainty. He elaborates his suggestion [78, 80], but Jina remains sceptical about it. Paul ignores her insightful comment [79] about the redundancy of the third dimension of the tank. Her final comment in [83] and serves two purposes. First, it expresses her scepticism about Paul's solution but it redresses the FTA by using the 'what if' scheme, and by offering one extreme (10) that agrees with Paul's proposal. Second, it expresses her own uncertainty about what the height of the water may be, by using the 'somewhere between' scheme.

Eventually, there were instances when a FTA was performed with no redressive action; these were cases when a student chooses to express disagreement or lack of understanding *baldly*. In the following exchange, for example, Jina perhaps feels unwilling to accept a solution that she does not comprehend; in any case, her turns [228, 230] are ‘dispreferred’:

227 Paul It goes to 25. 25 is  $\frac{1}{4}$  of 100, when the tank rests like that, so it'll go to  $\frac{1}{4}$  when it'll be like that.  $\frac{1}{4}$  of 40 is 10. But it's not a proof ...

228 Jina I don't get it.

229 Paul But I like my thinking very much, it ...

230 Jina It confused me.

It is also relevant to consider how these students use the personal pronouns ‘we’ and ‘you’ in their talk (Rowland, 1999). Only Jina uses ‘we’, while Paul’s expressions are mainly impersonal, with the exceptions of “what I’m doing seems too practical” [72] and “I like my thinking very much” [229]. ‘We’ serves two purposes. First, it is an indicator of joint activity and second, it is used as part of a politeness strategy ([79]). By uttering “we” in the particular moment Jina aims at expressing her scepticism towards Paul’s suggestion, but without threatening his positive face. She places herself alongside him, instead of expressing direct disagreement. Paul’s impersonal expressions, on the other hand, probably reflect his attempt to present his views in a ‘neutral’ way in order to minimise the threat to his own face in case of a potential mistake. The ‘you’ in [80] refers to nobody in particular, while the expression “what I’m doing seems too practical” [72] sounds more like egocentric talk, having also a ‘face-protecting’ function: it’s as if he is pointing out that his solution is not mathematically justified, before Jina can make the accusation. The same is the function of “it’s not a proof” [227], while in [229] Paul is praising himself, perhaps as a ‘face-maintaining’ strategy: after his partner utters her lack of understanding he feels exposed and in need of taking some redressive action.

## THE ENGLISH CASE

Jonathan was an undergraduate mathematics/education student in his early 20s. He had been working on the problem of finding the number of integer solutions of  $x^2+y^2 \equiv n \pmod{p}$  (a prime number). The supervision meeting considered here lasted about 45 minutes. Jonathan had made a number of conjectures at the previous supervision. The process most to the fore in this encounter is proof. Jonathan’s proposals are mostly skeletal, in need of detail, and the role of the supervisor (the second author) is to provide some scaffolding around his construction of the details. Early on, Jonathan claims that he has “an argument” for an earlier conjecture in the case  $n = 0$ . Before giving him opportunity to articulate the argument, the supervisor is eager for Jonathan to appreciate the distinction between the cases  $p \equiv \pm 1 \pmod{4}$ . His intervention [28] is an imposition on the student, and his reluctance to perform the FTA is evident in the hesitation [28] which has no fewer than six false starts:

- 28 Tim OK, OK. And, I mean, can I, I think, I just want to ask, does it hinge on the fact that in one case minus one is a quadratic residue and in the other case it isn't?
- 29 Jonathan [pause] Um ... well, yes [coughs] ... sort of. Um, I mean /it's, yes there's one/
- 30 Tim /[laughs] Would/ you like to rehearse the argument with me, or ...
- 31 Jonathan Well [coughs], yeah (yes), I'll come back to that bit about the quadratic residue bit. Um, but for where it's equal to one mod four ...
- 32 Tim Right.

The 'well' that initiates Jonathan's response [29] seems to be a hedge on Grice's (1975, p. 46) maxim of Quality:

Try to make your contribution one that is true. Do not say that for which you lack adequate evidence.

After coughs and pauses, the best he can claim is "sort of". Jonathan is then invited, at last, to express his argument [30], but the supervisor redresses the potential FTA (request) by an indirect speech act ("would you like") and by giving the option ("or") so that consent is not the only preferred response. Jonathan accepts the alternative, but realises that this might disappoint his supervisor. So although his answer [31] is (for the moment) "no", he presents it as "yes", appropriately marked by another hedge on Quality ("Well"). Thus, he asserts his right to present his argument in the way he chooses, but bears the supervisor's prompt [28] in mind and eventually responds to it later on. Soon, it becomes apparent that Jonathan's argument is incomplete.

- 47 Jonathan And, then there's this pairing thing ...
- 48 Tim Yeah?
- 49 Jonathan Which ... that's the bit I can't, I'm not... able to explain. I can't, I'm not, I can't say why they pair off, like that. Um, but then we've got, um,  $p$  minus one over two pairs [number of quadratic residues mod  $p$ ] [inaudible]
- 50 Tim Oh,  $p$  minus one over two squares.
- 51 Jonathan Yes. And so, so you get [long pause] yes, sorry, yes that's it. And they add up to give  $p$  each time, these two... these pairs of squares...
- 52 Tim Yes.
- 53 Jonathan So you've got  $p$  there, nought.
- 54 Tim [pause] Um, [hesitant] that's an absolutely fine ... um, I mean, let's think, we're talking about when  $p$  is congruent with one mod four here, aren't we?

Jonathan identifies the gap in his argument, which is to show that, when  $p \equiv 1 \pmod{4}$ , the quadratic residues can be always be paired to give sum zero. By accepting that he is not able to explain it [49], Jonathan poses a threat to his own face; this is a very crucial point, and the supervisor takes some redressive action with his "absolutely fine" and use of the inclusive 'we' [54]. It seems that the supervisor is caught between two conflicting needs: the need to correct Jonathan's argument on the one hand, and the need not to impose a threat to his positive face on the other.

## COMPARISON AND CONCLUSION

The basic similarity that can be traced is that speakers in both countries use vague language while they talk (about) mathematics. The students' attempts to articulate formal mathematical statements are hindered by their lack of specific knowledge, and this leads them to use various kinds of modal (e.g. 'should', 'must') and vague language by using hedges such as 'about' or 'probably'. In the Greek case, the students aim to protect their face when their reasoning is exposed to the researcher and their partner. In the English case Jonathan aims to protect his face when his thinking is placed under the microscope; his supervisor responds by using various forms of hesitation, inclusive and indirect language to redress his FTAs.

We also see similarities in the strategies deployed by the students to redress FTAs in both cases – to protect the student-partner in the Greek case, and the supervisor in the English case. Speakers express their attitudes in indirect ways, so as to reduce the threat to the interlocutor's positive face. What differentiates the two cases is that, under certain circumstances, speakers in the Greek case chose to perform a FTA with no redressive action; this was made in order for the speaker to protect face.

The analysis presented in this paper is intended to exemplify a way of seeing interactions taking place in educational settings, particularly those related to mathematics. As we have demonstrated, the politeness strategies deployed by students and/or teachers in England and Greece have some common features. This is not to say that both cultures share an identical set of linguistic strategies; what is evident though is a common tendency for participants in the articulation of mathematical reasoning to protect their own face, and sometimes that of other participants. Moreover, the Greek case demonstrates that protecting one's own face can take priority. As Rowland (2000, p. 125) states: "the participants care about the mathematics, but they also care about themselves, their feelings and those of their partners in conversation". In this paper, we have shown some similarities and differences in particular ways that this affective dimension is manifest in two European cultures, albeit with reference to different contexts and to small fragments of data. We believe that more extensive cross-cultural comparisons of this kind would be very profitable.

## References

- Austin, J. (1962). *How to do things with words*. Cambridge, MA: Harvard University Press.
- Bills, L. (2000) Politeness in teacher-student dialogue in mathematics: a socio-linguistic analysis. *For the Learning of Mathematics*, 20(2), 40-47.
- Brown, P., & Levinson, S. C. (1987). *Politeness: Some universals in language usage*. Cambridge: Cambridge University Press.
- Goffman, E. (1972). *Interaction Ritual: Essays on Face-To-Face Behaviour*. Harmondsworth, Middlesex: Penguin University Books.
- Grice, P. H. (1975). Logic and conversation. In P. Cole, & J. L. Morgan (Eds.), *Syntax and Semantics 3: Speech Acts*. New York: Academic Press, 41-58.

- Heritage, J. (1984). *Garfinkel and Ethnomethodology*. Oxford: Basil Blackwell.
- Jaszczolt, K. M. (2000). *The Pragmatics of Propositional Attitude Reports*. Oxford: Elsevier Science.
- Lakoff, G. (1973). Hedges: A study in meaning criteria and the logic of fuzzy concepts, *Journal of Philosophical Logic*, 2, 458-508.
- Moschkovich, J. (2003). What counts as mathematical discourse? In N. A. Pateman, B. J. Dougherty, & J. Zilliox (Eds.), *Proceedings of the 27th PME* (Vol. 3, pp. 325-331). Honolulu, USA: PME.
- Pirie, S. E. B. (1998). Crossing the Gulf between Thought and Symbol: Language as (Slippery) Stepping-Stones. In H. Steinbring, M. G. Bartolini Bussi, & A. Sierpiska, (Eds.), *Language and Communication in the Mathematics Classroom*. Reston, VA: National Council of Teachers of Mathematics, 7-29.
- Rowland, T. (1997). Fallibilism and the Zone of Conjectural Neutrality. In E. Pehkohen (Ed.), *Proceedings of the 21st PME Conference* (Vol. 4, pp. 80-87). Lahti, Finland: PME.
- Rowland, T. (1999). Pronouns in mathematics talk: power, vagueness and generalisation. *For the Learning of Mathematics*, 16(2), 20-26.
- Rowland, T. (2000). *The Pragmatics of Mathematics Education: Vagueness in Mathematical Discourse*. London: Falmer Press.
- Sadock, J. M. (1977). Truth and approximations. *Berkeley Linguistic Society Papers*, 3, 430-439.
- Schiffrin, D. (1994). *Approaches to Discourse*. Oxford: Blackwell.
- Searle, J. (1969). *Speech acts*. Cambridge: Cambridge University Press.
- Stubbs, M. (1986). 'A matter of prolonged fieldwork': notes towards a modal grammar of English. *Applied Linguistics*, 7(1), 1-25.
- Tatsis, K., & Koleza, E. (2004). The effect of students' roles on the establishment of shared meanings during problem solving. In M. J. Høines, & A. B. Fuglestad (Eds.), *Proceedings of the 28th PME Conference* (Vol. 4, 289-296). Bergen, Norway: PME.
- Wagner, D. (2003). Students and teachers listening to themselves: language awareness in the mathematics classroom. In N. Pateman, B. Dougherty & J. Zilliox (Eds.), *Proceedings of the 27th PME Conference* (Vol. 4, 355-362). Honolulu, USA: PME.



# TEACHERS USING COMPUTERS IN MATHEMATICS: A LONGITUDINAL STUDY

Michael O. J. Thomas

The University of Auckland

*The computer has been in mathematics classrooms for over 20 years now, but with widely varying implementation in mathematics teaching and learning. This paper describes a ten-year longitudinal research study that has investigated the changing nature of how secondary school teachers use computers in their mathematics classroom, and their perception of constraints or obstacles to improving, or extending, such use. The results show that while there are now many more computers available in schools, access remains a key obstacle to their increased use as mathematical learning tools. There is also a change in the kinds of software used, away from content-specific programs and towards generic software, especially the spreadsheet. Teacher attitude remains a key factor in progress.*

## INTRODUCTION

While many mathematics educators, including the author have been positive about the possible role of computers in the learning of mathematics (see e.g., Thomas & Holton, 2003), there have been doubts raised about a) whether computers have any real value in learning (Cuban, 2001) and b) whether current teacher use is qualitatively and quantitatively sufficient to promote benefits that might exist. Around 10 years ago Askew and Wiliam (1995) reported on a review of research in mathematics education in the 5-16 year age range, and found that “Although computers have been in use in mathematics education in this country [UK] for well over twenty-five years, the pattern of usage is still very varied and very sparse.” (p. 34). A UK Department of Education report (DFE, 1995) also noted a low level of computer usage in mathematics, with an average of 15.6 minutes of lesson time per week spent using the computer, and in the United States the position was very similar (Ely, 1993). While some might hope that this position has changed in recent years, a survey by Ruthven and Hennessey (2002) on school computer use concluded that “Typically then, computer use remains low, and its growth slow.” (p. 48).

There are a number of possible reasons for a low level of computer use in mathematics teaching and learning, including teacher inability to focus on the mathematics and its implications rather than the computer and many teachers not believing that the computer has real value in student learning. It has been argued that teacher factors outweigh school factors in the promotion of computer use, and Becker (2000a) reported on a national US survey of over 4000 teachers, concluding that “...in a certain sense Cuban is correct—computers have *not* transformed the teaching practices of a majority of teachers.” (p. 29). However, he noted that for certain teachers, namely those with a more student-centred philosophy, who had sufficient

resources in their classroom (5 or more computers), and had a reasonable background experience of using computers, a majority of them made 'active and regular use of computers' in teaching. Becker (2000b) has added a description of some characteristics of such an 'exemplary' computer-using teacher, but concludes that extending these to other teachers would be expensive. This paper reports on a ten-year longitudinal study describing the changing pattern of computer use in the mathematics classroom in New Zealand. Both the level and kinds of use were recorded, together with some of the obstacles teachers perceive to increased use.

## METHOD

Genuine longitudinal studies, where at least two sets of data are acquired from the same population over an extended time span, are relatively rare in mathematics education research. This longitudinal study, which has as its population all secondary mathematics teachers in New Zealand, began in 1995, when a postal questionnaire on computer use was sent to every secondary school in New Zealand. Replies were received from 90 of the 336 schools (26.8%), a reasonable response rate for a postal survey. Apart from information about the mathematics department in the school we received information from a total of 339 teachers in these 90 schools.

Some of the results of this survey were published at the time (Thomas, 1996). This original survey was followed by a second in 2005 in order to gain longitudinal data on how the situation might have changed over this period. In the years since 1995 teaching has become an even more stressful profession in many ways, particularly in terms of demands on time. Hence, teachers are more reluctant than ever to spend their valuable time filling in forms or research questionnaires. However, we had learned some lessons from 1995 and this time stamped, addressed envelopes were enclosed for all the schools and it was followed up several weeks later with a faxed copy. Using this approach we achieved a response from 193 of the 336 secondary schools in the country, an excellent 57.4% response. Completed questionnaires were received from a total of 465 teachers in these 193 schools, as well as the school information. In both years we are confident, due to the sample size, that the responses form a representative sample of the population of secondary school mathematics teachers, especially since we received a good proportion of responses from non-computer users (over 30% in each case). Of the respondents, in 1995 51.5% were male and 48.5% female, with a mean age of 41.5 years, whilst in 2005, 52.6% were male and 47.4% female, with a mean age of 44.8 years; the teachers are getting slightly older. While the questionnaires sent out in the two years were not identical, for example questions on the use of the internet were added in 2005, they had a considerable number of questions in common. They used closed and open questions to provide valuable data on issues such as: the number of computers in each school; the level of access to the computers; available software; the pattern of use in mathematics teaching; and teachers' perceived obstacles to computer use (see Figure 1 for a selection of questions from the second survey). This data enables us to come to some conclusions about the changing nature of computer use in the learning of mathematics in New Zealand secondary schools.

Q2	How often do you use computers in your mathematics lessons?	At least once a week	1
		At least once a month	2
		At least once a term	3
		At least once a year	4
		Never	5
Q5	Where are the computers you use usually situated?	In the computer room	1
		In the mathematics room	2
Q6	If the computers are in the mathematics room, how many do you usually have?	One	1
		Two	2
		Three	3
		Four	4
		Other_____	5
Q10	Please rank these areas of mathematics in the order in which you most often use the computer in your mathematics lessons i.e. 1 for most often, 2 for next etc. Leave blank any you do not use the computer for.	Graphical Work	___
		Algebra	___
		Trigonometry	___
		Geometry	___
		Statistics	___
		Calculus	___
		Other_____	___
Q13	Would you like to use computers more often in your mathematics lessons?	Yes	1
		No	2
Q14	If you answered yes to question 13, what do you see as obstacles to your use of them? Please rank in order any of these that apply (ie 1 for biggest obstacle, 2 for the next, etc.).	Lack of confidence	___
		Lack of training	___
		Computer availability	___
		Availability of software	___
		School policy	___
		Other_____	___
Q22	Please give the main advantage or benefit you have found, or feel to be true, of using technology in mathematics lessons_____		

Figure 1: Sample questions from the 2005 survey (some formatting changes).

## RESULTS

In 1995 67.2% of the teachers said that they used computers in their teaching, and this remained steady at 68.4% in 2005. Of these, in 1995, 5.9% said they used them at least once a week, and by 2005 this had risen to 13.3%. In 1995 the schools reported a mean of 40.0 computers per school, with 1.7 in the mathematics department. By 2005 this had increased to a mean of 74.4 computers per school (one outlier school with 1800 laptops was excluded), 21.9 of which are laptops and 26.9% of the schools now have over 100 computers. Mathematics departments have 6.5 computers on average (4.2 of which are laptops). One change has been the increase in the number of ICT rooms, up from 71% of schools in 1995 to 96%, with a mean of 2.46 rooms per school, up from 1.79 in 1995. However, while in 1995 89.1% of mathematics teachers usually used computers in labs this had dropped to 59.1% in 2005, with 10.7% using them mostly in their classroom. While numbers of computers have increased, has the pattern of use in teaching mathematics changed?

### Computer use in mathematics teaching

The mathematics curriculum in New Zealand schools is divided up into Number, Statistics, Geometry, Algebra and Measurement strands, along with a Processes

strand. Number and Measurement are principally primary and intermediate school activities (secondary school usually starts at age 13 years) so those using the computer were asked in which of the remaining curriculum areas (along with specific topics of graphs, trigonometry and calculus) they used them (see Table 1).

Area of Use	% of 1995 teachers (n=229)		% of 2005 teachers (n=318)	
	Some Use	Most Often Used	Some Use	Most Often Used
Geometry	34.1	4.8	28.2	3.9
Statistics	75.1	38.0	85.4	59.5
Graphical work	74.2	35.4	75.5	28.0
Algebra	32.3	4.8	33.4	3.5
Trigonometry	22.7	3.1	22.5	2.3
Calculus	24.0	3.9	22.5	2.6

Table 1: Curriculum areas where secondary teachers are using computers.

These figures show a significant increase in the use of computers for the learning of statistics, both as first choice curriculum area ( $\chi^2=24.5$ ,  $p<0.001$ ), and for some use ( $\chi^2=9.47$ ,  $p<0.01$ ). This not surprising since there is a strong emphasis on Statistics in New Zealand schools, and it lends itself to an approach where the computer can perform routine calculations, as well as graphical and investigational work. It is surprising in view of the excellent packages Cabri Géomètre and Geometers SketchPad, that there has been a fall (although not a significant one;  $\chi^2=2.07$ ) in the use of geometry packages. Cost may be a factor in this. Of the 193 schools in the 2005 survey only 20 mathematics departments had a technology budget, ranging from NZ\$200 to NZ\$15000, with a mean of NZ\$2762.50 (NZ\$1 $\approx$ US\$0.63), and one head of department commented that “Annual [software] fees also take up a lot of the allocated budgets”.

To gain some idea of the variety of uses that computers are being put to in schools each survey asked the teachers to rank in order of regularity of use the types of software they employed in teaching mathematics (see Table 2).

Area of Use	% of 1995 teachers (n=229)		% of 2005 teachers (n=318)	
	Some Use	Most Often Used	Some Use	Most Often Used
Spreadsheet	67.2	31.9	86.2	62.6
Mathematical Programs	61.1	25.8	34.3	5.0
Graph Drawing Package	61.1	22.3	50.9	17.7
Statistics Package	44.1	11.8	29.6	5.0
Internet	---	---	46.1	6.6

Table 2: Types of software used with computers.

It appears that there has been a significant change in the kinds of software used in mathematics classrooms over the period, away from specific content-oriented graphical ( $\chi^2=5.59$ ,  $p<0.05$ ), mathematical ( $\chi^2=38.7$ ,  $p<0.001$ ), and statistical packages ( $\chi^2=12.3$ ,  $p<0.001$ ), and towards generic software, especially the spreadsheet ( $\chi^2=28.0$ ,  $p<0.001$ ), which may handle statistical work well enough for secondary schools. The trend away from specific graphical packages is a little surprising since there are now some excellent programs, such as Autograph, available. Possibly the graphic calculator has made inroads into the use of the

computer for graphing functions. Questions on the use of the internet were new in 2005, and 46.1% of the teachers reported some use of it to teach mathematics. 61.1% of the teachers have access in their classroom (and 68.4% in a staff room). For the students, only 26.4% have classroom access, although 95.6% of schools have ICT rooms connected for them.

How do teachers organise their lessons around computer use? Since 1995 a number of student-centred constructivist perspectives on teaching very have been widely encouraged in mathematics education circles (e.g., von Glasersfeld, 1991; Ernest, 1997). Has this influenced how computers are used, as one might predict?

Method	% of 1995 teachers (n=229)		% of 2005 teachers (n=318)	
	Some Use	Most Often Used	Some Use	Most Often Used
Skill Development	67.7	37.6	58.5	24.5
Free Use	34.9	3.1	18.9	2.8
Investigations/PS	68.6	38.4	58.8	27.4
Demonstrations	40.6	10.9	59.6	29.7
Programming	8.7	1.3	6.9	1.6

Table 3: Teaching methods used with computers.

We can get some idea of what has happened in the classroom by looking at Table 3, which describes the methods that teachers employ when using the computer. The constructivist approach broadly encourages student-centred investigation and problem solving, rather than teacher-led instruction and enforcing of skills; so one might expect teachers to use the computer to do one or the other, but not both. However, in both 1995 and 2005 it appeared that a substantial proportion of teachers used both methods and did not see themselves on one side of a dichotomous ideological fence. This was shown by around 60% reporting computer use for skill development and demonstrations, as well as investigations. There was, however, a significant decline in the proportion of teachers using the computer for skill development ( $\chi^2=4.79$ ,  $p<0.05$ ), and in those allowing free use of the computer ( $\chi^2=18.0$ ,  $p<0.001$ ). However, the use of demonstrations significantly increased ( $\chi^2=19.5$ ,  $p<0.001$ ), and so the data implies that while directed use and demonstration is more common in 2005, it is not as often skill-directed. Again this is not entirely what one might expect from a constructivist perspective. We note that the percentage of teachers who value programming sufficiently to spend some time on it has remained reasonably constant, if somewhat low. It may be that those who are convinced that programming may encourage the formation of mathematical thinking have strong convictions. There are more recent ideas related to the value of programming that suggest that allowing students to interact with games where they are in control, programming attributes and functions in microworld-like games software may be beneficial for learning.

### Obstacles to computer use

In the original 1995 survey 93.5% of the teachers responded that they would like to use computers more in their mathematics teaching, however, in the latest survey those agreeing with this sentiment had dropped to 75.1%. While this is a highly

significant decrease ( $\chi^2=47.0$ ,  $p<0.001$ ), one must take into account the increased rate of use of computers, and hence some teachers may feel that they have reached their optimum usage level. In any case there is still a sizeable proportion of the teachers who would like to use them more, and so we are led to ask 'what factors do they perceive as preventing them from making greater use, or using them at all?' The results from the two surveys on this aspect are shown in Table 4.

Obstacle	% of 1995 teachers (n=339)		% of 2005 teachers (n=452)	
	First Mentioned	Mentioned	First Mentioned	Mentioned
Available Software	17.4	52.5	10.8	39.4
Available Computers	43.7	67.8	42.7	58.0
Lack of Training	17.4	45.4	7.5	31.9
Lack of Confidence	12.7	34.8	5.3	22.4
Government Policy	4.1	12.4	---	---
School Policy	0.6	8.0	0.4	9.3

Table 4: Obstacles teachers mention as preventing computer use in teaching.

In 1995 there were two areas where the teachers wanted to see improvement in order to reach their goal of using computers more. They were the provision of resources, in terms of available hardware and software and the increasing of their confidence through satisfactory training. In 2005 we see that the lack of training has been better addressed, with significantly fewer teachers mentioning it ( $\chi^2=15.2$ ,  $p<0.001$ ), although only 39.6% of the teachers had recently been on any kind of professional development covering use of technology to teach mathematics. Clearly there is still a need for training, since when department heads were asked how many of their mathematics teachers would not feel confident using technology in their teaching, the mean response was 3.1, compared with a total of 7.2 full time and 3.1 part time mathematics teachers. In addition, significantly fewer feel that they lack confidence in computer use ( $\chi^2=15.0$ ,  $p<0.001$ ), possibly due to greater penetration of computers in homes over the period. Further, the need for software may have been covered by the greater use of the spreadsheet, which is now provided with virtually all computers. However, the problem of the availability of computers remains the major issue. Although the number of computers in schools is increasing, since they are primarily located in large ICT rooms access to them by mathematics teachers is still the primary problem preventing greater use. The 2005 survey asked teachers if they seldom used the computer room what was the reason, and 38.7% said that it was because of the difficulty with booking the room, and a few said that it was too difficult to organize. There were very few other reasons of note given. Typical teacher comment were "Access to computers at required time (of year and within school timetable blocks)" was difficult, there is a problem "...getting into overused computer suites" and "Due to the increased demand for IT classes it is very difficult to book a computer room for a class of 20-30 students". In addition, in 1995 13% of teachers mentioned some other obstacle, and in 2005 the figure was 18.4%. These included the time and effort needed by both students and teachers in order to become familiar with the technology. It appears that some teachers are concerned that this instrumentation phase would impact on time available for learning mathematics.

## CONCLUSION

What does this research tell us about the changing face of computer use mathematics teaching in New Zealand secondary schools? The percentage of secondary mathematics teachers never using them has remained constant, at around 30%. While there are many more computers in the schools and an increased frequency of use, access to them is still the major obstacle to use in mathematics. They are usually in ICT rooms, and 89.6% of mathematics departments do not have their own technology budget. The primary uses of the computer are for graphical and statistical work, with the spreadsheet and a graph-drawing package the two most common pieces of software. There has been a significant decrease in the use of mathematical programs and statistical packages, and an expected increase in the use of the internet. While teachers are using computers less for skill development, its use is still high, and they have increased the use of demonstrations. Use of the computer is directed over 80% of the time. This pattern of changing use could not really be described as teachers warmly adopting the computer, and there are two important factors worth mentioning here. Only 20.7% of the schools had a technology policy in place, and when they did it usually comprised general statements such as “Technology should be used wherever possible as an aid to learning”, “All teachers are expected to integrate ICT into their teaching and learning practices“, “Access for all students to internet” or it specified what technology would be used by which year groups, or set rules for internet access and computer room use. Only rarely did it include the acquisition and replacement of software and hardware or the professional development of staff. Such an important omission has been noted previously (Andrews, 1999).

It is not surprising that without such a policy the use of computers in schools will tend to lack clear focus and direction. The second issue arose when the 2005 teachers were asked what they thought were the advantages and disadvantages of using computers (technology) in mathematics. While just 8% believed that it aided understanding (compared with 32% who thought it made working quicker or more efficient), 16.8% claimed that it impeded learning or understanding. As Manoucherhri (1999, p. 37) reported many “...teachers are not convinced of usefulness of computers in their instruction...”, they still feel, like Cuban (2001), that benefits are small or exaggerated, and students rely on technology too much. As several teachers in this research put it “I feel technology in lessons is over-rated. I don’t feel learning is significantly enhanced...I feel claims of computer benefits in education are often over-stated.”, “Reliance on technology rather than understanding content. “, and “Sometimes some students rely too heavily on [technology] without really understanding basic concepts and unable to calculate by hand.” Clearly teachers have a crucial role to play, and their beliefs and attitudes are major elements in the progress in computer use. This is an area for further research.

**Acknowledgment** I acknowledge the support of a Ministry of Education, New Zealand, Teaching, Learning and Research Initiative grant, without which this research would not have taken place. I am grateful to Charles Tremlett for some assistance with data analysis.

## References

- Ainsworth, S., Grimshaw, S., Underwood, J. (1999). Teachers implementing pedagogy through REDEEM, *Computers and Education*, 33(2-3), 171-187.
- Andrews, P. (1999). Some institutional influences on secondary mathematics teachers' use of computers. *Education and Information Technologies*, 4(2), 113-128.
- Askew, M., & Wiliam, D. (1995). *Recent research in mathematics education 5-16*, London: OFSTED.
- Becker, H. J. (2000a). Findings from the teaching, learning and computing survey: Is Larry Cuban right? Paper presented at the *2000 School Technology Leadership Conference of the Council of Chief State Officers*, Washington, DC.
- Becker, H. J. (2000b). How exemplary computer-using teachers differ from other teachers: Implications for realizing the potential of computers in schools. *Contemporary Issues in Technology and Teacher Education*, 1(2), 274-293.
- Cuban, L. (2001). *Oversold and underused: Computers in the classroom*. Cambridge, Massachusetts, USA: Harvard University Press.
- Department for Education (1995). *Statistical Bulletin*, 3/95, Darlington, UK.
- Ely, D. P. (1993). Computers in schools and universities in the United States of America, *Educational Technology*, 33(9), 53-57.
- Ernest, P. (1997). *Social constructivism as a philosophy of mathematics*. New York: SUNY Press.
- Manoucherhri, A. (1999). Computers and school mathematics reform: Implications for mathematics teacher education. *Journal of Computers in Mathematics and Science Teaching*, 18(1), 31-48.
- Ruthven, K. & Hennessy, S. (2002). A practitioner model of the use of computer-based tools and resources to support mathematics learning and teaching, *Educational Studies in Mathematics*, 49, 47-88.
- Thomas, M. O. J. (1996). Computers in the mathematics classroom: A survey, *Proceedings of the 19<sup>th</sup> Mathematics Education Research Group of Australasia Conference*, Melbourne, Australia, 556-563.
- Thomas, M. O. J., & Holton, D. (2003). Technology as a tool for teaching undergraduate mathematics. In A. J. Bishop, M. A. Clements, C. Keitel, J. Kilpatrick, & F. K. S. Leung (Eds.) *Second international handbook of mathematics education* (Vol. 1, pp. 347-390). Dordrecht: Kluwer.
- von Glasersfeld, E. (Ed.) (1991). *Radical constructivism in mathematics education*. Dordrecht, Holland: Kluwer Academic Publishers.



# ANALYSING CLASSROOM INTERACTIONS USING CRITICAL DISCOURSE ANALYSIS

Steve Thornton    Noemi Reynolds

University of Canberra    John Curtin College of the Arts

*There is a long history of studies of language and mathematics. Much of this has focused on the language of mathematics, and the role of language in developing mathematical understanding. A more recent emphasis has been on how language in the mathematics classroom illustrates power relationships. In this study we use the tools of critical discourse analysis, including systemic functional linguistics, to examine the extent to which student agency is promoted and evident in a year 8 mathematics classroom in Australia.*

There is a long history of studies of language and mathematics. Pimm (1987) suggests that there are three levels of relationship: mathematics and language, the mathematics of language or conversely the language of mathematics, and mathematics as a language. Zevenbergen (2000) discusses mathematics as a register with its own specialised vocabulary, semantic structure and lexical density. She maintains that language is a form of cultural capital, and suggests that students must learn to ‘crack the code’ of the mathematics classroom, a task which is less accessible to students from working class backgrounds than to students from middle class backgrounds.

A second emphasis, particularly in the constructivist literature, has been the role of language in learning mathematics. Brown (2001) points to the role of language in developing understanding, noting that mathematics can only be shared in discourse, mediated through social events. Alrø and Skovsmose (2002) stress that the quality of communication in the classroom is inextricably linked to the quality of learning, and discuss the role of dialogue in the learning of mathematics. In contrast to lessons containing genuine dialogue, many traditional mathematics lessons amount to little more than a game of ‘guess what the teacher thinks’ (Alrø & Skovsmose, 2002).

A more recent area of focus on language in mathematics has been on how language in the mathematics classroom illustrates power relationships (Walkerline, 1988; Zevenbergen, 2000). In a set of papers edited by Barwell (2005), bringing together the fields of mathematics education and applied linguistics, several writers considered issues such as the nature of academic mathematical discourse, and the relationship between the teaching and learning of mathematics and students’ induction into mathematical discourses. They claim that a view of language as a social practice is inseparable from a view of mathematics as social practice.

In this study we use the tools of critical discourse analysis to examine the extent to which student agency is promoted and evident in a year 8 mathematics classroom.

## CRITICAL DISCOURSE ANALYSIS (CDA)

Critical discourse analysis emerged in the 1980s as an attempt to synthesise language studies and social theory (Fairclough, 1992). It looks critically at the nexus of language/discourse/speech and social structure, attempting to uncover ways in which social structure impinges on discourse patterns and power relations (Blommaert & Bulcaen, 2000). It thus has the potential to look beyond superficial aspects of classroom language, and to illuminate aspects of agency (Boaler, 2003) and power in the classroom.

Fairclough (1992) considers discourse as a mode of action in which people act on the world and each other, in addition to being a mode of representation. He stresses that there is a dialectic relationship between discourse and social structure, with discourse on the one hand being constrained by social structure, and on the other as being socially constitutive. He sketches a three-dimensional framework for conceiving of and analyzing discourse, considering “every discursive event as being simultaneously a piece of text, an instance of discursive practice and an instance of social practice” (p4).

The first dimension is discourse-as-text, i.e. the linguistic features and organization of concrete instances of discourse. Building on the work of, for example, Halliday (1978), Fairclough maintains that text analysis must include a consideration of vocabulary, grammar, cohesion and text structure.

Fairclough’s second dimension is discourse-as-discursive-practice, i.e. discourse as something that is produced, distributed and consumed in society. He introduces the concepts of ‘force’ to describe what the text is being used to do socially, ‘coherence’ to describe the extent to which an interpreting subject is able to infer meaningful relationships and to make sense of the text as a whole, and ‘intertextuality’ to describe how texts are related historically to other texts (p 83).

Fairclough’s third dimension is discourse-as-social-practice, drawing on the Marxist concepts of ideology and hegemony. He claims that ideology is located both in the structure of discourse and in the discourse events themselves. For example, he suggests that the turn-taking practice of a typical classroom implies particular ideological assumptions about the social identities of and relationships between teacher and pupils (p 90). Hegemony concerns power that is achieved through constructing alliances and integrating groups. For example, in the classroom the dominant groups exercise power through integrating rather than dominating subordinate groups, winning their consent and establishing a ‘precarious equilibrium’.

Fairclough claims that this framework ‘allows one to combine social relevance and textual specificity in doing discourse analysis, and to come to grips with change’ (p 100)

## THE CLASSROOM

A transcript from a year 8 lesson (“Noemi’s classroom”) is provided in Appendix 1. This transcript is representative of the pattern of discourse observed throughout the lesson. The classroom atmosphere is relaxed and friendly, with a productive working relationship between students, and between the teacher and the students.

In Noemi’s classroom the students are exploring the mathematical concept of gradient, and attempting to discover for themselves the effect of changing  $a$  in the equation  $y = ax + b$ . They have drawn graphs using two or three numerical values, and are reporting to other students in the class on their findings. Students take it in turns to walk to the front of the class and sketch graphs on the whiteboard, explaining to other students what they have discovered, and responding to what other students have said.

## ANALYSIS OF THE DISCOURSE

Fairclough’s (1992) three-dimensional framework is used to analyse and compare the discourse in the two classrooms.

### Discourse as text

We discuss the field, tenor and mode of the text (Halliday, 1978), thus looking at the ideational, interpersonal and textual functions of the discourse (Morgan, 2005).

The field of discourse is overtly mathematics, with few, if any, diversions. In contrast to the patterns of interaction observed, for example, in the TIMSS 1999 video study (Hollingsworth *et al.*, 2003), the teacher intervened only to regulate the conversation (“One at a time, please” – Teacher), and to suggest things for the students to think about. In Noemi’s classroom the discourse is concerned with mental processes, the conversation being dominated by statements such as “I think”. On the other hand in many traditional classrooms the emphasis is on material processes or the creation of a product such as a solution to a problem. In Noemi’s classroom the discussions are public rather than private discussions, with students laying open their reasoning for public debate and potential criticism. There is a predominance of self and other questioning (“I was wondering...” – Sarah).

Noemi’s classroom thus features a discourse that is generative (Brown, 2001) rather than reproductive, with the goal (ideational function) of developing consensus around understanding a mathematical concept (“Well, it was about what Catherine said...” – Sam). On the other hand many of the TIMSS 1999 video classrooms featured reproductive discourse, with the apparent goal of students being to guess what was in the teacher’s mind.

The tenor of the discourse suggests the interpersonal function of language. In Noemi’s classroom Carly uses the personal pronoun “you” in an inclusive sense (“it’s what you think will best show...”), rather than the exclusive sense commonly found in mathematics texts, thus giving agency to other students. She also uses the phrase “what I found was...”, indicating a high degree of personal ownership of the

mathematics she was investigating. Noemi's classroom is marked by a high level of mutual support ("Go, Carly", and frequent applause). Students frequently self-correct ("I think what I was explaining..." – Catherine), in contrast to more traditional classrooms in which correction is carried out by the teacher. Noemi's classroom thus features a discourse in which students are empowered and emancipated mathematically, with relatively equal power relationships and knowledge being co-constructed.

The mode of the discourse refers to the certainty of the conclusions and the way in which cohesion is achieved (the textual function of language). In Noemi's classroom there is a clear flow in the discourse, with students building on what others have said. It has a predominance of given/new structures, a feature of mathematical argument ("I think that what Catherine said makes sense, but I think..."). Students talk at length, rather than giving short answers as reported in the analysis of the TIMSS videos, in which the average student response length was fewer than five words (Hollingsworth et al., 2003). Student discourse in Noemi's classroom is punctuated by "um" and ill-constructed sentences. Mathematical language is often vague or ill-defined, and symbols are used imprecisely ("if it was at 1 it would be at three", rather than "if  $y = 3x$ , then when  $x = 1$ ,  $y$  will be 3" – Campbelle). However in watching the video it is clear that the other students understand what is being said as it is accompanied by diagrams on the whiteboard. In contrast to many classrooms, the teacher does not intervene to correct language, nor to clarify what students say. The tentative nature of the language and concepts is valued ("On with my crazy scheme..." – Sarah), rather than mathematics being seen as something that is clearly defined and absolute.

Thus Noemi's classroom allows students to see mathematical knowledge as both personal and social, rather than mathematics as something impersonal waiting to be uncovered. Cohesion in Noemi's classroom is achieved through private and public reflection ("I was just thinking..." – Sarah) rather than through the apparently objective structure of mathematics as revealed by the teacher or text. In Noemi's classroom the 'dance of agency' (Boaler, 2003), in which agency moves between students and the agency of the discipline, is evident.

### **Discourse as discursive practice**

In Noemi's classroom the texts (conversations) are initiated by the students, re-expressed and reformulated by other students, and distributed publicly as students come to the whiteboard. The texts are then consumed by the class, and the cycle of production, transformation, distribution and consumption is repeated. In contrast the conversations in many traditional classrooms, such as in the TIMSS 1999 video study, are controlled by the teacher, the students responding in ways which they hope will be acceptable to the teacher, with each interchange being self-contained, initiated and concluded by the teacher. The 'force' of the discourse in Noemi's classroom is thus the social goal of including the entire class in the development of a shared understanding of the mathematical concept of gradient.

Although a preliminary reading of the transcript of Noemi's classroom, in the absence of the video with the accompanying whiteboard diagrams, may appear to lack coherence, in reality students in the class are able to construct a coherent and meaningful interpretation of what others were saying. Students are able to make sense of and build on what others say ("a lot of what Campbelle said was actually correct..." – Catherine), and the producer of each discourse event expects other students to understand ("it's really up to you and what you think will best show the lines on the graph..." – Carly). In more traditional classrooms coherence is produced by the teacher, by asking leading and prompting questions of students.

Noemi's class has manifest internal intertextuality in that each piece of discourse is related to a previous one. There is some evidence of students using conventional structures of mathematical argument, particularly as they strive to produce a generalisation of how changing the value of  $a$  affects the slope of the line. While they start by looking at specific examples, they attempt to generalise ("like can we represent the numbers on the  $y$  and  $x$  axis with something else?" – Sarah). At the conclusion of the transcript, Sarah shows a graph on the whiteboard in which the  $x$  axis increases in intervals of 1, while the  $y$  axis increases in intervals of  $a$ . She concludes that in this case every line will make a  $45^\circ$  angle with the axes. The text in Noemi's classroom illustrates a social practice which requires students to make their thoughts publicly available and to use the ideas of others to jointly build an understanding of a mathematical concept.

### **Discourse as social practice**

There is a marked contrast in the turn-taking practices and ratio of teacher to student talk between Noemi's classroom and the more typical pattern of Teacher – Student – Teacher observed in many of the TIMSS 1999 video lessons, in which the ratio of teacher to student talk was of the order of 8:1 (Hollingsworth et al., 2003). Noemi's classroom is characterised by a high level of equality between students and between the teacher and students. Power is located with students, and willingly given by the class to each student who is speaking ("Go Carly"). To a lesser extent students ascribe power to the argument produced by each student as they attempt to understand and build on each utterance. This is in contrast to more traditional classrooms in which students almost universally agree with what the teacher says.

In Noemi's classroom students see themselves as active participants in learning, who have power over both the mathematics and the discursive practices of the classroom. Students in many other classrooms willingly accept a more passive role, in which the mathematics being learnt has power over them, and in which the teacher maintains control of the discursive practice of the classroom. The hegemony of such classrooms is maintained through an unspoken alliance between teacher and students, in which the students become passive partners in maintaining a classroom where agency resides with the teacher.

## CONCLUSIONS

Critical discourse analysis has been used to analyse the conversation patterns and content in a year 8 mathematics classroom. In Noemi's words:

"My aim in my Mathematics classroom is for students to regard Mathematics as an art which belongs to them, a means of regarding and interpreting the world, a tool for manipulating their understandings, and a language with which they can share their understandings. My students' aim is to have fun and to feel in control.

"At the start of each year group responsibilities are established by class discussion and generally include rules such as every member is responsible for the actions of the other members of their group (this includes all being rewarded when one makes a significant contribution to the class and all sharing the same sanction when one misbehaves), members are responsible for ensuring everyone in their group understands what is going on at all times and students have some say in the make up of their groups .

"My role is primarily that of observer, recorder, instigator of activities, occasional prompter and resource for students to access. Most importantly, I provide the stimulus for learning what students need, while most of the direct teaching is done by the students themselves, generally through open discussion. Less obvious to the casual observer is my role of ensuring that students have the opportunities to learn all that they need to achieve required outcomes. It is crucial that I, as their teacher, let go of control of the class and allow students to make mistakes and then correct them themselves. An essential criteria for defining one of my lessons as successful is that I do less than 10% of the talking in the whole lesson."

Noemi's classroom exemplifies many of the conditions for learning through dialogue described, for example by Alrø and Skovsmose (2002). The discourse is exploratory, tentative and invitational, contains emergent and unanticipated sequences, is immediate, recognises alternative ideas even those that are strange (using shapes instead of numbers in an equation), and has a collaborative orientation in which students are vulnerable yet maintain high levels of mutual obligation.

In this way her classroom can be considered to be both empowering and emancipatory for students (Freire, 1972).

## References

- Alrø, H., & Skovsmose, O. (2002). *Dialogue and learning in mathematics education: Intention, reflection, critique*. Dordrecht: Kluwer.
- Barwell, R. (2005). Language in the mathematics classroom. *Language and Education*, 19(2), 97-101.
- Blommaert, J., & Bulcaen, C. (2000). Critical discourse analysis. *Annual Review of Anthropology*, 29, 447-466.
- Boaler, J. (2003). *Studying and capturing the complexity of practice - the case of the 'dance of agency'*. Paper presented at the 2003 Joint Meeting of PME and PMENA, Honolulu, HI.
- Brown, T. (2001). *Mathematics education and language: Interpreting hermeneutics and post-structuralism*. Dordrecht: Kluwer.

- Fairclough, N. (1992). *Discourse and social change*. Cambridge, UK: Polity Press.
- Freire, P. (1972). *Pedagogy of the oppressed*. Harmondsworth: Penguin.
- Halliday, M. A. K. (1978). *Language as social semiotic: The social interpretation of language and meaning*. London: Edward Arnold.
- Hollingsworth, H., Lokan, J., & McCrae, B. (2003). *Teaching mathematics in Australia: Results from the TIMSS 1999 video study*. Camberwell, Vic: Australian Council for Educational Research.
- Morgan, C. (2005). Words, definitions and concepts in discourses of mathematics, teaching and learning. *Language and Education*, 19(2), 103-117.
- Pimm, D. (1987). *Speaking mathematically: Communication in mathematics classrooms*. London: Routledge & Kegan Paul.
- Walkerdine, V. (1988). *The mastery of reason*. London: Routledge.
- Zevenbergen, R. (2000). "Cracking the code" of mathematics classrooms: School success as a function of linguistic, social, and cultural background. In J. Boaler (Ed.), *Multiple perspectives on mathematics teaching and learning* (pp. 201-224). Westport, CT: Ablex.

Appendix 1: Transcript of Noemi's classroom

- Class            Go Carly
- Carly            Um, I think that what Catherine said makes sense but I think that when it comes to the values that you go up by on the graph it's really up to you and it's what you think will best show the lines on the graph. But what I found with 'a' is that the higher the value of 'a' the more acute the angle will be compared to the y-axis. So say, um, it was  $4x$  then it will be closer to the y-axis than  $2x$ . 'Cause  $2x$  will be here the  $4x$  will be here. I found that the lower the value the closer it was to the x-axis. But the higher the value the closer it was to the y-axis. (*Applause and a 'whoo'*)
- Sarah            Just a question. I was wondering do you even need the, um ... the numbers. 'Cause where it says  $5a$  don't, can't you just go like  $7a + 2$  or something. Like can we represent the numbers on the y and x axis with something else? *Laughs*
- Class            *Laughter, murmurs.*
- Cameron        Like shapes? (*Laughter*) So you could like do like squares, circles, triangles...
- Sarah            Yeah but this is just more easy. (*Inaudible*)
- Teacher        One at a time please. Could we just have one at a time? Kate, what did you just say?
- Kate            I was saying that if you replace the numbers with like shapes and letters and stuff it's just a complicating thing 'cause we all know the number system and it's simpler for us than all these other symbols.
- Sarah            Yeah, but what I'm saying is, like, if, why we're using the number system we're really, um, pinpointing the graph 'cause then we're saying ... one,

one and y one, sorry, and we're just you know we're really pinpointing, I mean using numbers and if we like if we can find a way to represent it with letters then we'd be able to make it whole infinity, infinity instead of just drawing on the graph. Does that make sense?

Class *Muttering, faint "No"*

Teacher That might be something for people to have a think about. Sam, you had a comment before Sarah ... talked about this stuff.

Sam\* Well, it was about what Catherine said about having the ... axis and the lines, the scale was being affected by 'a'. What I you know thought was that 'a' doesn't just affect the y-axis but it affects the x-axis as well. I mean that if you're making a graph you want to put the, make the line cover the largest amount of distance possible. For example, that would look a lot better than having a graph that looked like that. 'Cause it's a lot easier to read. See? If, if, if - a good way to be able to get a graph, a graph looking like this (*points to one graph*) or like this (*points to another graph*) depending on whether *a* is negative or positive would be good. So that's where the scale comes in. (*Edited*) (*Applause*)

Campbelle Um, I found that with those ones that it's kind of saying that for every one *x* there's going to be 3 *y*. So, with ... if it's one, two three - if it was at 1 it would be at three, if it was that because that for every 1 *x* there is 3 *y*. If it was at 2 it would be at 6 and so on. So it's, yeah, like that and with that one for every 1 *x* there's 4 *y*. (*Applause*)

Teacher Catherine?

Catherine I think what I was explaining what I was doing before as  $3x$ , I think I was mixing up the scale, um, a lot Campbelle was saying is also actually correct. If it was 1 it would be 3, so if  $y = 415x$ , then, well  $x = 1$  then up here and 415. If you're going... I don't know what you'd go up by but it would be like, um, that so it would go up there and that here it would go there so like right straight like that. (*Edited*) (*Applause*)

Oakley (*edited*)

Teacher Any other comments? (*Waits*) I was going to give you something else to think about.

Sarah On with my crazy scheme to play, to change the numbers... Crazy scheme is cool. Um, I just thought of this 'cause I was just thinking you know how I could do it...and you know how it says up here 3 plus you know how she said up by 3 so then the y-axis would go up by 3...back to the  $y = ax$  that means....(*camera cuts out*).

\*This child has a stutter.



# PRE-SERVICE AND IN-SERVICE MATHEMATICS TEACHERS' CONCEPT IMAGES OF RADIAN

Tahsin Topçu, 75. Yıl Mesut Yılmaz İlköğretim Okulu, İstanbul, Turkey

Mahmut Kertil & Hatice Akkoç, Marmara University, İstanbul, Turkey

Kamil Yılmaz, Deniz Lisesi, İstanbul, Turkey

Osman Önder, Deniz Harp Okulu, İstanbul, Turkey

*This study investigates pre-service and in-service mathematics teachers' subject knowledge of radian. Subject knowledge is investigated under the theoretical frameworks of concept images and cognitive units. Qualitative and quantitative research methods were designed for this study. Thirty seven pre-service and fourteen in-service mathematics teachers' completed a questionnaire which aims to assess their understanding of radian. Three pre-service and one in-service teachers were selected for individual interviews on the basis of theoretical sampling. The data indicated that participants' concept images of radian were dominated by concept images of degree.*

## INTRODUCTION

Trigonometry is one of the topics in mathematics education research which did not receive enough attention. As stated by Fi (2003), much of the literature on trigonometry has focused on trigonometric functions (Even, 1989; Even, 1990; Bolte, 1993; Howald, 1998). Other studies focus on the learning and teaching of trigonometry and trigonometric functions with computers and calculators (Blacket & Tall, 1991; Wenzelbuer, 1992; Silva, 1994; Lobo da Costa & Magina, 1998). A few researchers studied more specific issues in trigonometry such as simplification of trigonometric expressions (Delice, 2002) and relationship between trigonometry and forces in physics (Doerr & Confrey, 1994).

There is little research on teachers' understanding of trigonometry (Doerr, 1996; Fi, 2003). This study focuses on pre-service and in-service mathematics teachers' understanding of a specific concept in trigonometry, namely the radian. Fi (2003) found that although pre-service mathematics teachers were successful with conversation between radians and degrees, none of them was able to accurately define the radian measure as a ratio of two lengths: the length of the arc of a central angle of a circle and the radius of the circle.

## THEORETICAL FRAMEWORK

The subject knowledge of pre-service and in-service mathematics teachers' concept images of radian was investigated under the theoretical frameworks of concept images and cognitive units. Tall & Vinner (1981) introduce the notions of concept definition and concept image and makes a distinction between the two. They define concept definition as the 'form of words used to specify that concept' (p. 152). A

formal concept definition is one accepted by the mathematical community at large. As Tall & Vinner (1981) assert, we can use mathematical concepts without knowing the formal definitions. To explain how this occurs, they define concept image as ‘the total cognitive structure that is associated with the concept, which includes all the mental pictures and associated properties and processes’ (p. 152). They assert that it is built up over the years by experience, and that different stimuli at different times can activate different parts of the concept image developing them in a way which need not be a coherent whole. Vinner (1992) asserts that specific individuals create idiosyncratic images and also the same individual might react differently to a concept encountered within different situations.

A chunk of the concept image in which an individual can consciously focus attention at a time is called a *cognitive unit* by Barnard & Tall (1997). A cognitive unit has also links (many of which are unconscious) to the other parts of our cognitive structure. Cognitive units can be symbols, representations, theorems, properties. The authors claim that powerful mathematical thinking requires compressing the information to fit into cognitive units and making connections between them. The authors also claim that ‘what is a cognitive unit for one individual may not be a cognitive unit for another’ (p. 41).

Under these theoretical frameworks, this study tries to answer the following research questions:

- What kind of concept images of radian do participants have?
- What are the sources of such concept images?

## METHODOLOGY

To be able to answer the research questions above, qualitative and quantitative research methods were designed for this study. The data was collected using questionnaires and semi-structured interviews. Thirty seven pre-service and fourteen in-service mathematics teachers’ completed a questionnaire which aims to assess their understanding of radian. Three pre-service and one in-service teacher were selected for individual interviews on the basis of theoretical sampling. As Mason (1996) asserts theoretical sampling means selecting a sample on the basis of their relevance to the research questions and theoretical positions to be able to build in certain characteristics or criteria which help to develop and test the theory and explanation. Therefore, two participants (one pre-service and one-in-service teacher who are represented by R1 and R2) were selected to have stronger concept images of radian and two participants (who are both pre-service teachers and are represented by the D1 and D2) were selected to have strong concept images of degree.

### Research instruments

The aim of the questionnaire was to reveal concept images of radian. Participants were asked to evaluate the values of outputs of trigonometric functions when the inputs are given and visa versa.

The aim of the interview was to investigate the concept images in detail and the sources of these concept images. We are particularly interested in the role of right triangle and unit circle as cognitive units in the concept images. The interviews were video-taped and were transcribed. Interviews were semi-structured and included three questions. First, participants were asked to prepare a concept map of trigonometry using little post-it papers. They were asked to draw the concept maps after they finished organising the concept maps. They were also asked follow-up questions about their concept maps. Second, they were asked to draw the graph of a trigonometric function. In the third question they were asked the definition of radian.

## RESULTS FROM THE QUESTIONNAIRE

Participants responded to the following questions in the questionnaire:

- 1)  $f : R \rightarrow R$  and  $f(x) = x \sin x$  is given. Plot the following points on the Cartesian plane.  
 a)  $(30, f(30)) = ?$     b)  $(\pi/2, f(\pi/2)) = ?$     c)  $(\pi/6, f(60)) = ?$     d)  $(2, f(\pi/3)) = ?$
- 2)  $f : R \rightarrow R$  and  $f(x) = \cos x$  is given. If  $f(x) = -\sqrt{3}/2$   $x = ?$
- 3)  $f : R \rightarrow R$  and  $f(x) = \sin x$  is given. If  $\sin x = a \Leftrightarrow \arcsin(a) = x$  then find the following: a)  $\arctan(1) = ?$  b)  $\arctan(-\frac{\sqrt{3}}{2}) = ?$

The analysis of the responses to the questions indicated the following categories:

- *Correct*: Seeing 30 as a reel number and considering it as an angle in radians
- *Degree image*: Considering 30 as  $30^\circ$ , but not seeing it as a reel number
- *No plotting*: Finding the values correctly without plotting the points
- *Other*: Other responses which cannot be categorised further
- *No response*: Giving no response
- *NA*: The category is not applicable for that question

The results from the questionnaire were summarised in the table below:

N=51	Correct	Degree image	No plotting	Other	No Response
1-a	3.9	90.2	0	5.9	0
1-b	62.7	23.5	3.9	9.8	0
1-c	5.9	92.2	0	0	2
1-d	62.7	25.5	2	3.9	3
2	39.2	56.9	NA	3.9	0
3	56.9	39.2	NA	0	2

Table 1. Frequencies for the questions in the questionnaire

As seen in the table above, participants' concept images of radian were dominated by the concept of degree. For instance, although it was mentioned that the function was defined from real numbers to real numbers, 90.2% of them considered "sin 30" in question 1a in degrees. In other words, they found the value for  $\sin 30^\circ$  but did not consider 30 as a real number. Only 3.9% of them considered sin 30 in radians.

Similarly, in question 2, only 39.2% of the participants found  $x$  in radians while 56.9% of them found  $x$  in degrees.

## RESULTS FROM THE INTERVIEWS

The aim of the interview was to investigate the concept images in detail and the sources of these concept images. Interviews were semi-structured and included three questions. Below an account of participants' responses were presented.

### Concept maps

The aim of the concept maps was to investigate the sources of participants' concept images. We were particularly interested in the place of the unit circle and the right triangle in the concept maps. Participants were also asked to explain how did they prepare their maps. The original concept maps were drawn electronically since the words were translated into English. Therefore, they should be considered as representations of participants' original concept maps.

R1 prepared the following concept map in figure 1:

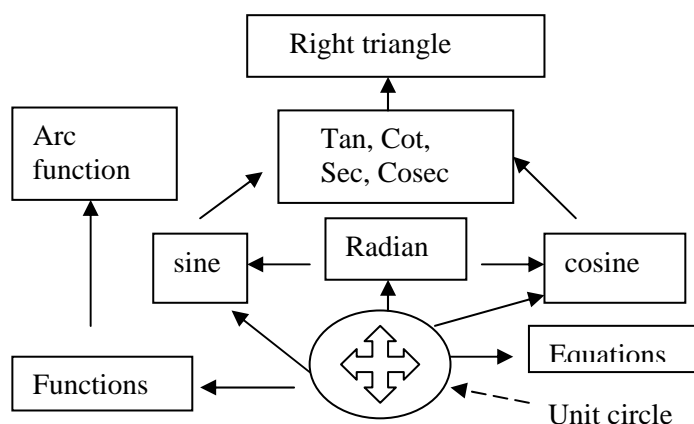

Figure 1. Concept map of R1

He mentioned that the unit circle is almost linked to every concept in trigonometry. He also stated that when he teaches trigonometry he always introduce it with the unit circle.

R2 prepared the following concept map in figure 2 below:

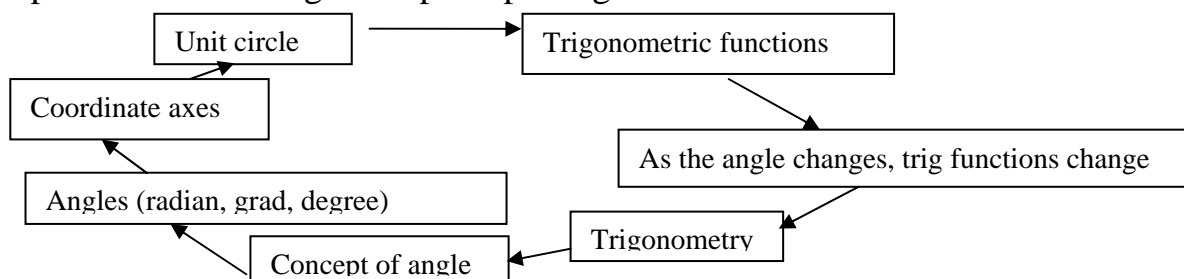

Figure 2. Concept map of R2.

He started his concept map from “trigonometry” cell in the bottom right and continued clockwise. He stated that he defines trigonometric functions using the unit circle. When he was asked where he would put the “right angle” in his concept map,

he said that “it is like your name which is obvious to you. It is no where but actually everywhere”.

D1 prepared the following concept map:

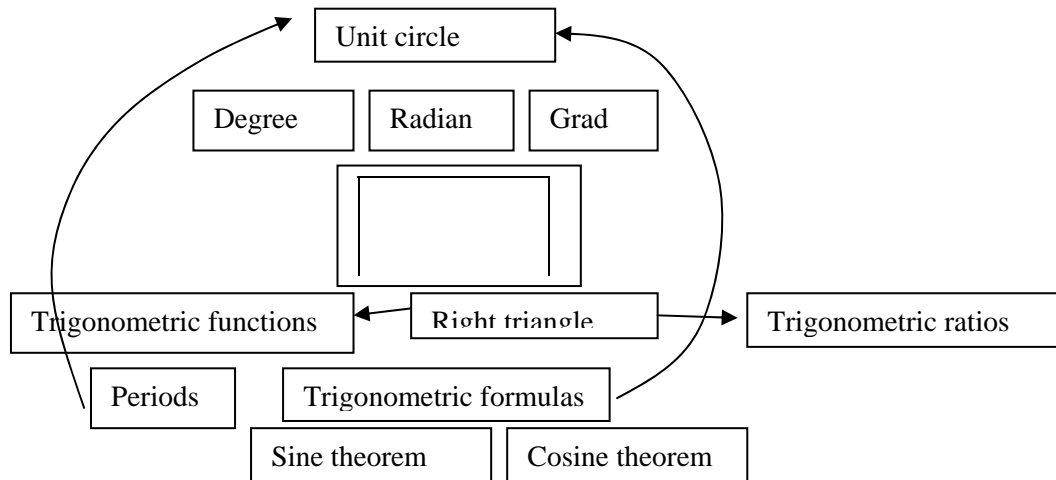

Figure 3. Concept map of D1.

She started her concept map with the unit circle on the top. When she was explaining trigonometric functions, she defined the sine, cosine, tangent and cotangent using the right triangle. However, when she was explaining the periods of these functions and where the sine and cosine are positive and negative, she used the unit circle.

D2 prepared a hierarchical concept map as follows:

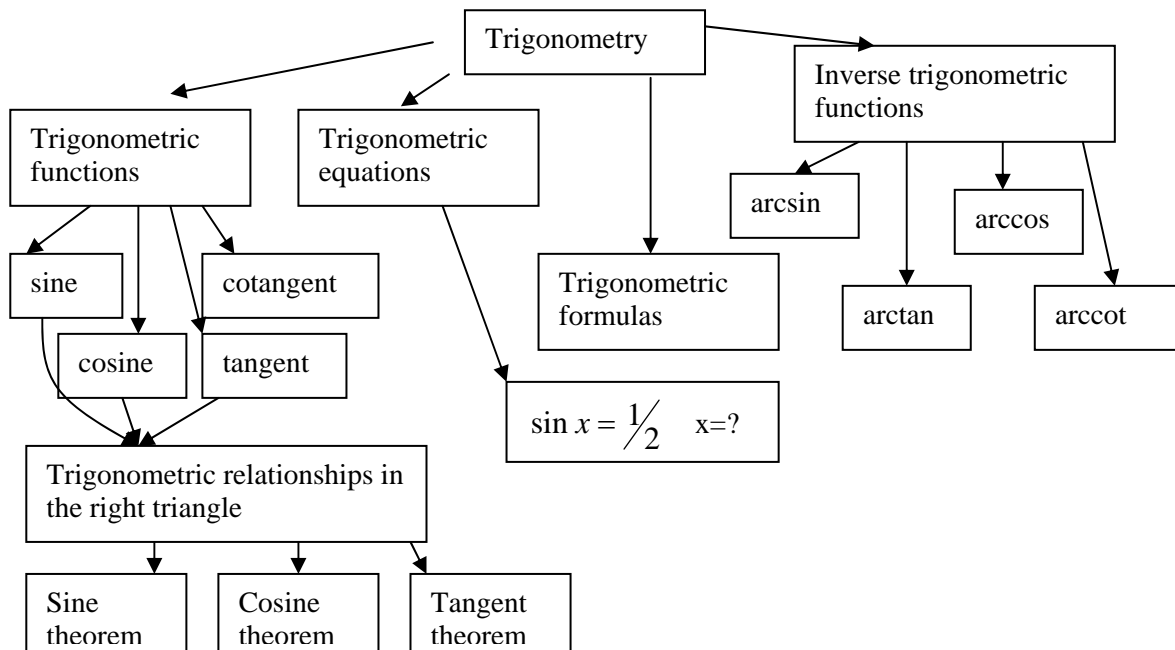

Figure 4. Concept map of D2.

Unit circle did not appear in the concept map of D2. She related the trigonometric functions (sine, cosine, tangent, cotangent) to the right triangle.

As can be interpreted from the concept maps of the participants, unit circle had richer connections in the concept maps of R1 and R2 (who have stronger concept image of radian) while right triangle exists in the concept maps of D1 and D2.

## The graph of sine function

In the interview, participants were secondly asked the following question after they drew the graph of sine function:

*Suppose you are teaching your students how to draw the graph of sine function and suppose you plotted the points  $(0,0)$  and  $(\pi/2,1)$  then drew the graph in that interval. How would you explain if one of your students asks you why you did not draw the graph straight?*

R1 drew the graph correctly but did not explain why it not straight using the unit circle. He just stated that the sine function is not a linear function.

R2 explained it using the unit circle:

R2: I would use the unit circle. First I look at the value of sine at zero, then bigger angles. As I go towards ninety degrees my vector (along the y-axis) gets bigger. However, it gets bigger faster first, until forty-five degrees. After that it gets bigger slower. That's why it is not straight.

D1 also made use of the unit circle. She referred to a computer software as shown below and explained that the values do not grow proportionally:

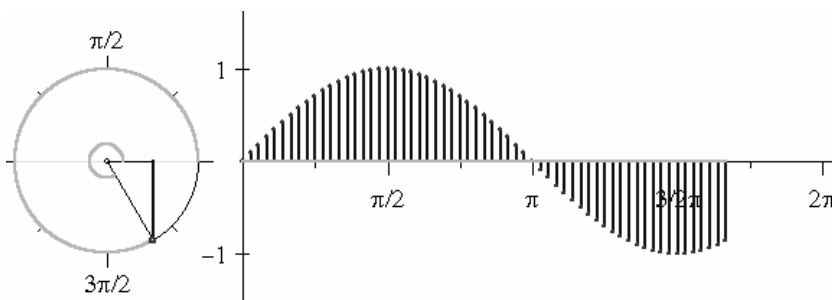

Figure 5. Picture from the computer screen explaining the graph of sine function

D2 could not explain why the graph was not straight. She first said that the function was increasing; therefore it could not be straight. When she was asked the reason why, she mentioned that straight lines are not increasing but functions such as sine and cosine are increasing and decreasing. She said that

D2: This is an increasing function. When it is increasing or decreasing it cannot be a line. Because an equation for a line is like  $y = x + 2$ . When you substitute values for  $x$  then  $y$  is constant. But functions like sine and cosine are decreasing and increasing. That is why the graph cannot be straight. If the graph is towards up, it is increasing. If it is going down, it is decreasing.

As seen from her response she could not relate the drawing of the graph to the unit circle.

## Personal concept definition of radian

When the participants were asked the definition of radian, the equation  $\frac{D}{180} = \frac{R}{\pi}$  acted as a cognitive unit. Their personal concept definition is dominated by that equation. Excerpts from their responses are given below:

- R1: Divide the degree by a hundred and eighty and multiply it by  $\pi$ . One radian represents the ratio of  $360^0$  which is in the centre of the unit circle to the circumference of the circle.
- R2: If we divide a circle into three hundred and sixty pieces, we call the one piece as degree. If we divide the circle into two hundred pieces, we get the grad. If we divide it into  $2\pi$  we get a radian.
- D1: Radian is the whole of  $360^0$ , it is  $2\pi$  radian. Consider the unit circle...these are all choices, I can define my own unit. Let's divide it into six hundred, call it something else, like the grad.
- D2: First of all, degree divided by a hundred and eighty equals to radian divided by  $\pi$ . Radian means the angle, it is the multiples of  $\pi$  when we think of  $\pi$  as a hundred and eighty degrees...it is the value in terms of  $\pi$ .  $30^0$  is  $\frac{\pi}{6}$ . Radian of angle means its value in terms of  $\pi$ .

As can be interpreted from the responses above, none of the participants successfully defined the radian as a ratio of two lengths: the length of the arc of a central angle of a circle and the radius of the circle. R1's personal concept definition is the closest to the accurate definition.

## DISCUSSION AND CONCLUSION

This study investigated pre-service and in-service mathematics teachers' concept images of radian and the sources of such concept images. The data from the questionnaire revealed that most of the participants' concept images of radian was not rich enough and were dominated by their concept images of degree. Participants did not consider radian as a real number although the trigonometric functions that were given to them were explicitly defined on the set of real numbers. The interview data suggested possible sources of such concept images. First of all, the equation  $\frac{D}{180} = \frac{R}{\pi}$  acted as a cognitive unit for the participants. None of the participants defined the radian as a ratio of two lengths. Secondly, participants who have stronger concept images of radian established richer connections between unit circle and other concepts in trigonometry as revealed from the concept maps and the graph drawing task. On the other hand, participants who have stronger degree images have right triangle as one of their cognitive units. Another possible source might be that the concept image of  $\pi$  in the context of trigonometry is different from the concept image of  $\pi$  as a real number. Further research is needed to investigate these findings in detail especially the role of the unit circle and right triangle as cognitive units in trigonometry.

## References

- Barnard, T. & Tall, D.O. (1997). Cognitive Units, Connections and Mathematical Proof. *Proc. 21<sup>st</sup> Conf. of the Int. Group for the Psychology of Mathematics Education* (Vol. 2, pp. 41-48). Lahti, Finland: PME.
- Blacket, N. & Tall, D.O. (1991). Gender and the versatile learning of trigonometry using computer software. *Proc. 15<sup>th</sup> Conf. of the Int. Group for the Psychology of Mathematics Education* (Vol. 1, pp. 144-151). Lisbon, Portugal: PME.

- Delice, A. (2002). Recognising, recalling and doing in the 'simplification' of trigonometric expressions. *Proc. 26<sup>th</sup> Conf. of the Int. Group for the Psychology of Mathematics Education* (Vol. 1, p. 274). Norwich, UK: PME.
- Doerr, H. (1996). Integrating the study of trigonometry, vectors, and force through modelling. *School Science and Mathematics*, 96 (8), 407 – 418.
- Doerr, H. M. & Confrey, J. (1994). A modelling approach to understanding the trigonometry of forces: a classroom study. *Proc. 18<sup>th</sup> Conf. of the Int. Group for the Psychology of Mathematics Education* (Vol. 2, pp. 264 - 271). Lisbon, Portugal: PME.
- Fi, C. (2003). Preservice Secondary School Mathematics Teachers' Knowledge of Trigonometry: Subject Matter Content Knowledge, Pedagogical Content Knowledge and Envisioned Pedagogy. *Unpublished PhD Thesis*, University of Iowa: USA.
- Mason, J. (1996). *Qualitative Researching*. London: Sage.
- Nielce Lobo da Costa & Sandra Magina (1998). Making sens of sine and cosine functions through alternative approaches: Computer and "experimental world" contexts. *Proc. 22<sup>th</sup> Conf. of the Int. Group for the Psychology of Mathematics Education* (Vol. 2, pp. 224-231). Stellenbosch, South Africa: PME.
- Silva, Z. L. (1994). A geometric – algebraic approximate to the trigonometric functions with the use of supercalculators. *Proc. 18<sup>th</sup> Conf. of the Int. Group for the Psychology of Mathematics Education* (Vol. 1, p. 71). Lisbon, Portugal: PME.
- Tall, D.O. & Vinner, S. (1981). Concept Image and Concept Definition in Mathematics with Particular Reference to Limit and Continuity. *Educational Studies in Mathematics*, Vol. 12, pp. 151-169.
- Vinner, S. (1992). The Function Concept as a Prototype for Problems in Mathematics Learning. In G. Harel, & E. Dubinsky, (Eds) *The Concept of Function: Aspects of Epistemology and Pedagogy*, MAA, pp. 195-213.
- Wenzelbuer, E. (1992). The learning of trigonometric functions in a graphical computer environment. *Proc. 16<sup>th</sup> Conf. of the Int. Group for the Psychology of Mathematics Education* (Vol. 3, pp. 106-114). Durham, USA: PME.



## ADAPTIVE EXPERTISE IN THE NUMBER DOMAIN 20-100

Joke Torbeyns<sup>1,2</sup>, Lien Vanderveken<sup>2</sup>, Lieven Verschaffel<sup>2</sup>, and Pol Ghesquière<sup>2</sup>

<sup>1</sup> Postdoctoral Fellow of the Fund for Scientific Research (F.W.O.)--Flanders

<sup>2</sup> University of Leuven, Belgium

*This study analyzed the flexibility with which 2<sup>nd</sup>-graders of high, above average, or below average math achievement level solved additions and subtractions up to 100. Children answered 4 types of additions and subtractions before and after regular classroom instruction in 1 choice and 2 no-choice conditions. Our results revealed differences in children's adaptive expertise at both measurements. High achievers flexibly fitted their strategy choices to item and strategy performance characteristics, whereas above and below average achievers hardly took into account item and strategy performance characteristics during the strategy choice process.*

As advocated by the adherents of the worldwide reform movement of mathematics education, mathematics instruction should no longer focus on the acquisition of routine expertise but rather foster the development of adaptive expertise (Kilpatrick et al., 2001; Verschaffel et al., in press). Routine expertise can be defined as the ability to complete school mathematics tasks fast and accurately using standardized school-taught strategies without (much) understanding. In contrast, adaptive expertise refers to the ability to solve mathematical tasks efficiently, creatively, and flexibly with diverse meaningfully acquired strategies (Baroody & Dowker, 2003).

Reformers favouring adaptive expertise assume that promoting variable and flexible strategy use is feasible and valuable across different levels of achievement, including the weaker ones. However, these recommendations to go beyond routine expertise and to aim also for adaptive expertise, are, up to now, too much based on rhetoric and too little on convincing research-based evidence (Geary, 2003). Therefore, we aimed at analyzing the development of adaptive expertise in children of different mathematical achievement levels in the domain of adding and subtracting up to 100. By doing so, we did not only hope to deepen our understanding of children's acquisition of adaptive expertise, but also to provide building blocks for answering the critical instructional questions about the feasibility and desirability of teaching for variable and flexible strategy use, esp. with weak achievers.

### PREVIOUS STUDIES IN THE NUMBER DOMAIN 20-100

During the last decade, an ever-growing number of researchers (a.o., Beishuizen, 1993; Blöte et al., 2000, 2001; Carpenter et al., 1997; Cooper et al., 1996; Fuson et al., 1997; Heirdsfield, 2001, 2002; Heirdsfield & Cooper, 2004) have tried to unravel the nature of children's use of (informal) strategies for mentally computing multi-digit additions and subtractions. These studies revealed that children generally use three different types of strategies to solve sums and subtractions up to 100, namely (a) split strategies, i.e. splitting off the tens and the units in both integers and handling

them separately (" $49 + 25 = .$ ;  $40 + 20 = 60$ ;  $9 + 5 = 14$ ;  $60 + 14 = 74$ "); (b) jump strategies, i.e. counting up or down the tens and the units of the second integer from the first un-split integer (" $49 + 25 = .$ ;  $49 + 20 = 69$ ;  $69 + 5 = 74$ "); and (c) varying strategies, involving the adaptation of the numbers and operations in the sum on the basis of one's understanding of the number relations and the properties of operations, like in the compensation (" $49 + 25 = .$ ;  $50 + 25 - 1 = 75 - 1 = 74$ "), and the short-jump or complementary addition strategy (" $71 - 69 = .$ ;  $69 + 2 = 71$ ; so the answer is 2").

Although these studies deepened our understanding of children's strategy competencies in the number domain up to 100, their results are limited by two weaknesses. First, previous studies analyzed children's adaptive expertise on the basis of item characteristics only, and did not directly address the influence of other variables on children's strategy choices, like the characteristics of the strategies (e.g., accuracy, speed) or the subject (e.g., achievement level) (Payne et al., 1993; Siegler, 1996). Second, their results do not converge on the feasibility of instruction aiming at adaptive expertise for children of the weakest mathematical achievement level. Whereas some studies (Klein et al., 1998) indicate that mathematically weak children profit also from instruction aiming at variable and flexible strategy use, others (Milo & Ruijsenaars, 2002) question the value of this instruction for weak children.

Taking into account these two weaknesses, the aim of the present study was to analyze the development of children's adaptive expertise in the domain of addition and subtraction up to 100 on the basis of item as well as strategy performance (accuracy, speed) and subject (math achievement level) characteristics. Taking into account the results of our pilot studies indicating that Flemish 2<sup>nd</sup>-graders hardly apply varying strategies on sums up to 100, we focused on the flexible use of the jump and split strategy. We used the choice/no-choice method to analyze strategy adaptiveness on the basis of strategy performance characteristics (Siegler & Lemaire, 1997; Torbeyns et al., 2004). This method requires testing each participant under two types of conditions. In the choice condition, participants can choose which strategy they use on each item. In the no-choice condition(s), participants are experimentally forced to solve all items with one particular strategy. The fine-grained comparison of the strategies in the choice condition and the strategy efficiency data from the no-choice conditions allows a researcher to assess whether participants take into account strategy performance characteristics during the strategy choice process: do they select (in the choice condition) the strategy that leads fastest to an accurate answer to the item (as evidenced by the data from the no-choice conditions)?

## METHOD

### Participants

The children and teachers of four 2<sup>nd</sup>-grade classes for regular education in Flanders participated in the study ( $n = 69$ ). We assessed children's general math achievement level and their strategy competencies in the number domain 20-100 halfway and at the end of 2<sup>nd</sup> grade, resp. before and after instruction in two-digit addition and subtraction. Children were offered two standardized mathematics achievement tests

(Arithmetic Halfway and End 2<sup>nd</sup> Grade, resp., AH2 and AE2) (Dudal, 2000) to assess their mathematical achievement level at the first and second measurement time. Children were divided into three groups on the basis of their scores on the AH2: (a) high achievers scored at or above the 75<sup>th</sup> percentile on the AH2 ( $n = 30$ ); (b) above average achievers scored between percentile 50 and 74 ( $n = 20$ ); (c) below average achievers received a score below the 50<sup>th</sup> percentile ( $n = 19$ ). The groups differed in their scores at the first and second time, resp.  $F(2, 66) = 157.71$ ,  $p < .0001$ ;  $F(2, 66) = 67.65$ ,  $p < .0001$ . In line with our criteria, high achievers solved more items on the AH2 and AE2 accurately than above average achievers, who scored higher on the AH2 and AE2 than below average achievers.

We gathered information about the instruction in the number domain 20-100 by interviewing the teachers at the first and second measurement time. We complemented these interview data with a careful analysis of the textbook used by the teachers. The structured interviews and the textbook analyses revealed that all children had received systematic instruction in the characteristics of our base-ten numeration system up to 100 by the time of the first measurement. At the second time of measurement, all children had learned how to solve two-digit additions and subtractions without a carry ( $53 + 12 = .$ ) and with a carry ( $58 + 16 = .$ ). As advised by the textbook authors, all teachers had provided explicit instruction only in the jump strategy. Children had extensively practiced the correct execution of the jump strategy with MAB materials, as well as the notation on their work sheets of all steps involved in the execution of that strategy. None of the teachers had provided explicit instruction in a strategy other than the jump strategy at the second measurement time.

### Materials and Conditions

All children were offered a series of four types of two-digit additions and subtractions ( $n = 5$  per type): (a) additions without a carry, i.e. addition-no-carry or ANC ( $25 + 23 = .$ ); (b) additions with a carry or AC ( $28 + 25 = .$ ); (c) subtractions without a carry or SNC ( $48 - 23 = .$ ); (d) subtractions with a carry or SC ( $45 - 28 = .$ ).

At both measurement times, all children were individually administered the series of items in one choice and two no-choice conditions. In the choice condition, children could choose between the jump and split strategy on each item by means of pictures that visualized the respective strategies. An example is given in Figure 1.

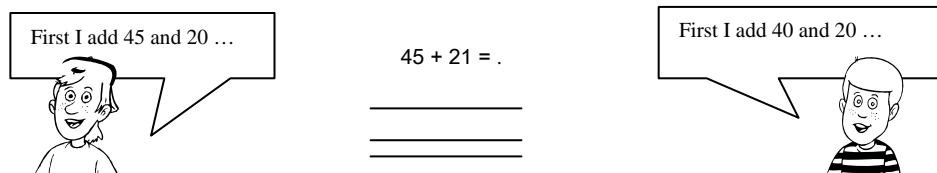

Figure 1: Presentation of items in the choice condition

The child on the left side of Figure 1 represents the jump strategy; the child on the right side the split strategy. In line with classroom practice, children were asked to write down all steps included in the strategy chosen. In the no-choice conditions, the split and the jump condition, children were required to solve all items with the split and the jump strategy by means of the instruction and the presentation of the items.

On the first day of testing, all children solved the items in the choice condition. About half of the children continued with the split condition on the second day, and ended with the jump condition on the third day. For the remaining children, the order of the no-choice conditions was reversed. The experimenter registered the accuracy and speed of responding per child and per item in each condition.

## RESULTS

### Strategy Repertoire and Distribution in the Choice Condition

Both the jump and the split strategy were used in the three groups of children at the first and second time of measurement. Moreover, the two types of strategies occurred on all problem types at both measurement times. Children were highly consistent in their strategy use: more than half of the children solved all items either with the jump (22%) or with the split strategy (48%) at the first time; about half of the children only applied the jump (23%) or the split strategy (23%) at the second time. Furthermore, more than half of the children did not change their strategy repertoire between the two measurement times (55%). Despite the instructional focus on only the jump strategy, one fifth of the children solved all items with the split strategy at the first time, and continued to solve all items with that (untaught) strategy at the second time. We found no group differences in strategies at the first and the second time, resp.,  $\chi^2(4; n = 69) = 2.05$ ,  $p = 0.7271$ , and  $\chi^2(4; n = 69) = 4.72$ ,  $p = 0.3173$ . We observed no group differences in the changes in strategies,  $\chi^2(2; n = 69) = 0.30$ ,  $p = 0.8607$ .

As could be expected on the basis of the instruction, we observed an increase in the number of items solved with the jump strategy between the two measurements,  $F(1, 2622) = 173.66$ ,  $p < 0.0001$ . Whereas children solved only 20% of the items with the jump strategy at the first time, they answered almost half of the items (47%) with this strategy at the second time. Moreover, high achievers showed a greater tendency to adapt their strategies to the instruction than the other children,  $F(2, 2622) = 5.31$ ,  $p = 0.0050$ . At the first time, there was no difference between the low frequencies of the jump strategy between high achievers ( $M = 31\%$ ) and above and below average achievers (resp.,  $M = 11\%$  and  $M = 15\%$ ); at the second time, the former solved more items with the jump strategy ( $M = 74\%$ ) than the latter (resp.,  $M = 27\%$  and  $M = 39\%$ ).

### Strategy Choices in the Choice Condition

Although our analyses of children's strategy repertoire and distribution revealed that children changed their strategy choices in the choice condition in line with the instruction provided in the classroom, they did not completely adapt their strategy behaviour to the classroom instruction. Such a complete adaptation would have resulted in the exclusive reliance on the jump strategy for solving all items in the choice condition at the second measurement time. Hereafter we analyze the influence of other variables than the instruction provided, i.e. item and strategy performance characteristics, on children's strategy selection process at the two measurement times.

In line with Beishuizen (1993), we first assessed whether children took into account item characteristics during the strategy choice process, by calculating the frequency of the jump strategy on the different types of additions and subtractions. We analyzed the frequency of the jump strategy in the choice condition on the basis of group, problem type, measurement time, and their interactions. These analyses revealed a significant interaction among group, problem type, and time,  $F(6, 2622) = 2.43, p = 0.0242$ . High achievers applied the jump strategy less frequently on ANC and AC than on SNC and SC problems at the first as well as the second time of measurement, and thus fitted their choices to the item characteristics. In contrast, above average achievers used the jump strategy more often on AC than on SNC problems at the first time. But at the second time, they also solved SNC and SC problems more frequently with the jump strategy than ANC and AC problems, and thus adapted their choices to the item characteristics. Below average achievers applied the jump strategy with the same frequency on the different problem types at the first time, and solved SNC and SC problems (not more, but) less often with the jump strategy than ANC problems at the second time. In other words, below average achievers did not take into account the characteristics of the items during the strategy choice process.

Second, we analyzed children's strategy choices on the basis of their strategy performance characteristics. Following Siegler and Lemaire (1997), we calculated, for each item, the correlation between the differences in the accuracy and speed of the jump and split strategy in the no-choice conditions, and the frequency of the jump strategy in the choice condition. These analyses revealed a significant positive correlation between the frequency of the jump strategy and the differences in the accuracy and the speed of the jump and split strategy for high achievers at the first (resp.,  $r = 0.75, p = 0.0001$ ;  $r = 0.67, p = 0.0011$ ) and the second time (resp.,  $r = 0.64, p = 0.0023$ ;  $r = 0.60, p = 0.0050$ ). High achievers thus used the jump strategy most often on the items they could solve most efficiently with this strategy, fitting their strategy choices to their strategy performance characteristics at both measurement times. In contrast, above and below average achievers did not take into account their strategy performance characteristics during the choice process at both measurement times. We observed a significant negative correlation between the frequency of the jump strategy and the differences in the accuracy and speed of the jump and split strategy for above average achievers at the first measurement time (resp.,  $r = -0.69, p = 0.0007$ ;  $r = -0.40, p = 0.0793$ ). Above average achievers thus applied the jump strategy least frequently on the items they could solve most efficiently with the jump strategy. At the second time, we observed a non-significant positive correlation between the frequency of the jump strategy and strategy accuracy and speed for above average achievers (resp.,  $r = 0.30, p = 0.1939$ ;  $r = 0.15, p = 0.5399$ ). For below average achievers, we found non-significant (negative) correlations between strategy frequency and strategy accuracy and speed at the first (resp.,  $r = -0.34, p = 0.1426$ ;  $r = -0.35, p = 0.1292$ ) and second time (resp.,  $r = -0.34, p = 0.1407$ ;  $r = -0.14, p = 0.5502$ ). So, below average achievers did not take into account their strategy performance characteristics during the choice process at both measurement times.

## DISCUSSION

How can we explain these differences in the (development of the) adaptive nature of high achieving and of above and below average achieving children's strategy choices? Two plausible explanations for this result are differences in the degree of children's conceptual understanding and differences in their disposition to flexibly apply varied strategies. As argued by Baroody and Dowker (2003), Heirdsfield (2001, 2002, 2004), and Verschaffel et al. (in press), both subject variables are hypothesized to affect the degree of children's adaptive expertise. High achievers presumably had, already before the start of classroom instruction, a higher degree of mathematical understanding of number and operations in the number domain 20-100 and a more genuine disposition towards strategy flexibility, resulting in a high degree of adaptive choices already at the first time. Although the exclusive instructional focus on the jump strategy led to a clear increase in high achievers' use of this strategy, it did not prevent them from continuing to switch flexibly between the jump and split strategy, relying on their presumably high degree of conceptual knowledge and disposition towards strategy flexibility. In contrast, above and below average achievers probably had a lower degree of conceptual understanding and a less developed disposition towards strategy variability and flexibility at the start of instruction. We hypothesize that the exclusive instructional attention on the jump strategy neither facilitated the construction of a good conceptual knowledge base nor the development of an inclination towards variable and flexible strategy use in these children, resulting in few adaptive choices at both measurement times. Apparently, whereas high achievers may prosper despite the type of instruction they received, lower achievers may need carefully designed instructional activities to acquire adaptive expertise. Longitudinal studies, focusing on the development of children's conceptual understanding and their disposition towards flexible strategy use, in relation to the acquisition of adaptive expertise, are needed to test this hypothetical explanation.

While the results of the present study provide important new insights in the development of children's strategy choices, they also raise some critical issues that require further attention. First, although our conceptualization of adaptive strategy use is heavily influenced by recent information-processing models on the structures and mechanisms that underlie the strategy selection process (Payne et al., 1993; Siegler, 1996), it still does not grasp the full complexity of strategy adaptiveness. As argued by Baroody and Dowker (2003), developing and demonstrating adaptive expertise is probably not only influenced by cognitive, but also by socio-emotional and socio-cultural variables, such as social and socio-mathematical norms (Yackel, 2001). Although this study provided indirect evidence for the influence of these norms on children's strategy choices, it does not provide a clear answer to the question to what extent the prevailing social and socio-mathematical norms in the classrooms co-determined (the development in) children's strategy choices. Second, the choice/no-choice method was valuable to unravel whether children adapt their strategy choices to their strategy performances. Unfortunately, the sound application of this method requires the researcher to design one no-choice condition for each of

the strategies used in the choice condition, resulting in a "restricted-choice" instead of a "genuine free choice" condition in most studies (Torbeyns et al., 2004). This problem jeopardizes to some extent the ecological validity of the findings from our study. A third remark concerns the ascertaining nature of our work. Although such studies provide indirect evidence about the characteristics of math instruction that might facilitate strategy flexibility in the domain of elementary arithmetic, they need to be complemented with carefully designed teaching experiments to directly assess the efficacy of instructional tools aimed at enhancing children's adaptive expertise, and to evaluate the feasibility and desirability of such instruction for mathematically weak children in particular.

## References

- Baroody, A. J., & Dowker, A. (2003). *The development of arithmetic concepts and skills: Constructing adaptive expertise*. Mahwah, N. J.: Lawrence Erlbaum Associates.
- Beishuizen, M. (1993). Mental strategies and materials or models for addition and subtraction up to 100 in Dutch second grades. *Journal for Research in Mathematics Education*, 24, 294-323.
- Blöte, A. W., Klein, A. S., & Beishuizen, M. (2000). Mental computation and conceptual understanding. *Learning and Instruction*, 10, 221-247.
- Blöte, A. W., Van der Burg, E., & Klein, A. S. (2001). Students' flexibility in solving two-digit addition and subtraction problems: Instruction effects. *Journal of Educational Psychology*, 93, 627-638.
- Carpenter, T. P., Franke, M. L., Jacobs, V. R., Fennema, E., & Empson, S. B. (1997). A longitudinal study of invention and understanding in children's multidigit addition and subtraction. *Journal for Research in Mathematics Education*, 29, 3-20.
- Cooper, T.J., Heirdsfield, A.M., & Irons, C.J. (1996). Years 2 and 3 children's correct-response mental strategies for addition and subtraction word problems and algorithmic exercises. In Puig, L.; Gutiérrez, A. (Eds.), *Proceedings of the 20th PME International Conference*, 2, 241-248.
- Dudal, P. (2000). *Leerlingvolgsysteem. Rekenen: Toetsen 1-2-3. Basisboek* [System for following pupils. Arithmetic: Tests 1-2-3. Textbook]. Leuven, Belgium: Garant.
- Fuson, K. C., Wearne, D., Hiebert, J., Murray, H., Human, P., Olivier, A., Carpenter, T., & Fennema, E. (1997). Children's conceptual structures for multidigit numbers and methods of multidigit addition and subtraction. *Journal for Research in Mathematics Education*, 28, 130-162.
- Geary, D. C. (2003). Arithmetical development: Commentary on Chapters 9 through 15 and future directions. In A. J. Baroody & A. Dowker (Eds.), *The development of arithmetic concepts and skills: Constructing adaptive expertise* (pp. 453-464). Mahwah, N. J.: Lawrence Erlbaum Associates.
- Heirdsfield, A. M. (2001). Integration, compensation and memory in mental addition and subtraction. In Van den Heuvel-Panhuizen, M. (Ed.), *Proceedings of the 25th PME International Conference*, 3, 129-136.

- Heirdsfield, A. M. (2002). Flexible mental computation: what about accuracy? In Cockburn, A.D.; Nardi, E. (Eds.), *Proceedings of the 26th PME International Conference*, 3, 89-96.
- Heirdsfield, A. M., & Cooper, T. J. (2004). Factors affecting the process of proficient mental addition and subtraction: Case studies of flexible and inflexible computers. *The Journal of Mathematical Behavior*, 23, 443-463.
- Kilpatrick, J., Swafford, J., & Findell, B. (2001). *Adding it up. Helping children learn mathematics*. Washington, D. C.: National Academy Press.
- Klein, A. S., Beishuizen, M., & Treffers, A. (1998). The empty number line in Dutch second grades: Realistic versus gradual program design. *Journal for Research in Mathematics Education*, 29, 443-464.
- Milo, B., & Ruijssenaars, A. J. J. M. (2002). Strategiegebruik van leerlingen in het speciaal basisonderwijs: begeleiden of sturen? [Strategy instruction in special education: Guided or direct instruction?] *Pedagogische Studiën*, 79, 117-129.
- Payne, J. W., Bettman, J. R., & Johnson, J. R. (1993). *The adaptive decision maker*. Cambridge, U. K.: University Press.
- Siegler, R. S. (1996). *Emerging minds*. New York: Oxford University Press.
- Siegler, R. S., & Lemaire, P. (1997). Older and younger adults' strategy choices in multiplication: Testing predictions of ASCM using the choice/no-choice method. *Journal of Experimental Psychology: General*, 126, 71-92.
- Torbeyns, J., Verschaffel, L., & Ghesquière, P. (2004). Efficiency and adaptiveness of multiple school-taught strategies in the domain of simple addition. In Høines, M.J.; Fuglestad, A.B. (Eds.), *Proceedings of the 28th PME International Conference*, 4, 321-328.
- Verschaffel, L., Greer, B., & De Corte, E. (in press). Whole number concepts and operations. In F. Lester (Ed.), *Handbook of research in mathematics teaching and learning* (second edition). New York: MacMillan.
- Yackel, E. (2001). Explanation, justification and argumentation in mathematics classrooms. In Van den Heuvel-Panhuizen, M. (Ed.), *Proceedings of the 25th PME International Conference*, 1, 9-24.



# MATHEMATICAL ACTIVITY IN A TECHNOLOGICAL WORKPLACE: RESULTS FROM AN ETHNOGRAPHIC STUDY

Chrissavgi Triantafillou & Despina Potari

University of Patras

*This paper investigates mathematics in the setting of a telecommunication organization through a number of tool mediated activities used by three different groups of professionals. The theoretical and analytical framework is guided by “activity theory” and the research methodology follows the ethnographic tradition. The results indicated that three different aspects of mathematics- procedural, conceptual and theoretical emerged in the work activities, while a number of general strategies were developed during breakdown situations. The role of the particularities of different instruments and of the professionals’ academic background was also discussed.*

## INTRODUCTION

Mathematics in the workplace is an area that has received considerable attention over the last decade. This study adopts the perspective that mathematics cannot be considered in isolation from the work context, and is hidden in technological tools (Keitel, Kotzmann & Skovsmose, 1991; Pozzi, Noss & Hoyles, 1998). The work reported here is part of a research project that aims to study how and whether the students who are doing their practicum in workplace settings can build bridges between their academic mathematical experiences and those involved in these settings. The results discussed come from a one-year ethnographic study that aimed to develop our own understanding of this specific context; to identify authentic situations that could be used to study students’ understanding; and to plan mathematics education grounded on actual workplace practice. This paper investigates mathematics in the setting of a telecommunication organization, a domain in which little research has been carried out, and which lies in a rapidly changing technological environment. It also explores to what extent a range of tools, from technologically primitive to technologically advanced, and the different backgrounds and experiences of the technicians, influence the particularities of workplace mathematical activities. Tool mediation as a unit of analysis in different groups of technicians has not been widely investigated (Magajna & Monaghan, 2003; Strasser, 2000). Moreover, most work in this area has focused on the practices of skilled or semi-skilled workers. The main research goals here are to trace, identify and analyse elements of knowledge of different groups of professionals in tool mediated activities that can be described in terms of a well-defined set of mathematical traits and strategies; and to investigate whether these elements are conceived of by the professionals as being essential in their work activity.

## **THEORETICAL FRAMEWORK**

We adopt a socio cultural perspective where mathematics is embedded in the work context and is mediated through the tools. The activity theory developed by Vygotsky, Leont'ev and their followers (discussed in Daniels, 2001) has guided our study. A key element of this theory is the concept of tools, artifacts and instruments, which mediate actions. According to Cole (1996), artifacts are objectifications of human needs and intentions already invested with cognitive and affective content while a tool is a subcategory of the notion of artifact. A tool "becomes" an instrument, which is a combined unit of both the person and the artifact (Rabardel, 1995). The concept of instrument is close to what Wartofsky (sited by Cole) describes as a secondary artifact, which consists of representations both of primary artifacts and of modes of action using primary artifacts (axes, tools etc). It also plays a central role in preserving and transmitting modes of action and belief. In this theory, mathematics and language provide the means to create and manipulate secondary artifacts and are characterized as tertiary artifacts. In our view, mathematical activity in its "abstract" sense can be seen as a tertiary artifact, while in the workplace it can be considered as a secondary artifact because it is embedded in the work activity. A framework of our data analysis is the first generation activity theory model (cited by Daniels, 2001, p. 86), which is represented by a triangle that demonstrates relations between mediational means, the subjects and the object of the activity. In our study the mediational means include all forms of artifacts used, the subjects are the different categories of professionals and the object is the specific goal of the activity.

## **METHODOLOGY**

The workplace was the National Telecommunication Organization in a small Greek town and in a satellite earth station near Athens. This context was unfamiliar and massively complex, both mathematically and technologically. The ethnographic research method that was adopted lasted one year and the visits took place, on average, once a week giving a total of 70 hours observations and interviewing. In this paper we refer to three groups of participants. In group A, the technicians used measuring instruments to identify the fault in an underground wire. Four technicians with vocational backgrounds were in this group. In group B, the technicians had to install, programme and operate a Private Branch Exchange. The instruments used were computer mediated. Four technicians with mostly vocational qualifications belonged to that group. In group C, the participants were four "experts" with academic backgrounds who worked in the satellite earth station. The instruments used were either measuring or computer mediated. The methods of collecting data were participant observation, interviewing, and collection of artifacts, technical and academic textbooks. The observation involved shadowing and interviewing subjects informally at work. The interviews ranged from informal conversations in the beginning of the study to semi- structured interviews at the end. Field notes were kept and discussions between the researcher and the subjects were often audio-recorded. The collected artifacts were worksheets, technical maps, manuals, cables and photos.

The data was categorised according to the type of work situation, the tools used, and the mathematical activity that implicitly or explicitly was required.

**RESULTS**

In Figure 1 we present in a systemic network (Bliss, Monk & Ogborn, 1983) the elements that comprise the work activity.

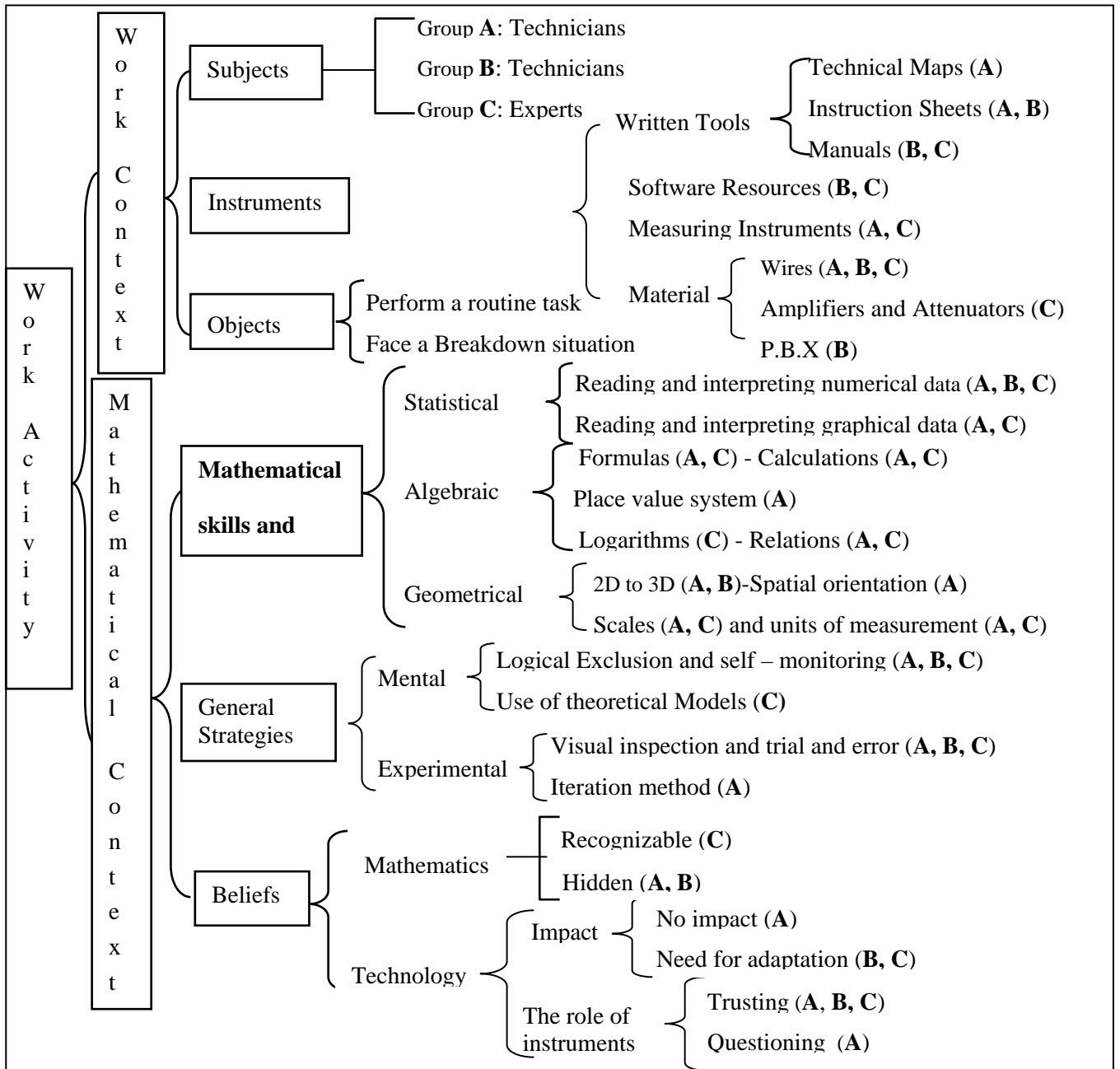

Figure 1: Elements of the Work Activity

We distinguish this situation in terms of the work context and the mathematical context. The mathematics context is actually embedded in the work context, is illustrated by the bracket, and it is linked to all three elements that are recognised in the work context. In reference to the work context, the activity is analysed according to the three elements of the first generation activity theory model, the subjects which are the three groups of technicians, the instruments which are the instruments that are

used by the specific groups of professionals and the objects are the two main work activities, a routine task and a breakdown situation. The mathematical context is analysed in three parts according to the different aspects of mathematics recognised in the work activity. The first part involves the mathematical concepts and skills, the second focuses on the general strategies that developed during breakdown situations and the last part describes how they conceived of mathematics and technology in their profession. In the network we also present which group (A, B or C) corresponds to each specific category.

### Mathematical concepts and skills

#### **Group A: Locating a fault in an underground wire - pair:**

The major working tools of group A were wire-pairs that were bundled together into cables consisting of between 10 and 600 pairs. Their data was taken from two sources: the working instructions and a technical map. Their first job was to understand and interpret the data, and then to find the faulty wire on a specific board in a telecommunication closet. The mathematical skill required here was the ability to use the place value system. They also used formulas, carried out arithmetical calculations, read and interpreted numerical and graphical data, moved from 2-dimensional to 3-dimensional space and used spatial orientation, scales and units of measurement. The method of interpreting graphs was mostly based on the recognition of specific forms that indicated the kind of fault. Below, we can see how the technicians could specify a wire-pair successfully in the closet. A regular working instruction is as follows: 16 141 74 39 4/9

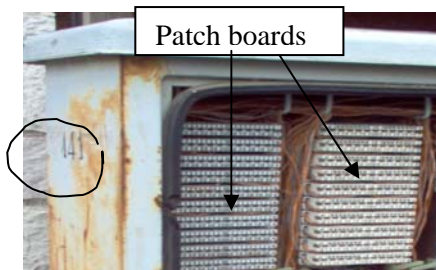

This instruction translates into: the cable number 16 goes to closet 141 (which means the 41<sup>st</sup> in the north of the main building since digit 1 indicates its northern location in relation to the main building)(see photo). The particular wire-pair we focus on is number 74, which means that it can be found in the 4<sup>th</sup> place of the 8<sup>th</sup> patch board of the incoming frame counting from the top. (Having completed 7 groups of ten, we place the wire – pair in the 8<sup>th</sup> group of ten.). Similarly, they found the corresponding outgoing wire – pair from the number 39. The indication 4/9 describes more clearly exactly the same as the previous indication. In this example, the technicians worked in two different notational systems, the arithmetic and its practical representation in the closet. As they reported, initially they had difficulty in linking the two systems. Finally, this became an automatic operation for them. However, they did not seem to be aware of these two co-existing systems and their relations. Another finding was that their conceptions of algebraic relations among variables remained at an intuitive level. To describe the mathematical relation between the electrical resistivity of a wire, its length and its cross sectional area, they provided a well known metaphor from their vocational studies:

“... The current in the wires is like the water in a canal; when you want to send water a great distance, you must use a pipe with a larger diameter to avoid the losses.”

### **Group B: Installing and Programming a telecommunication network**

In the second category the technicians' main task was installing and programming the **Private Branch Exchange (PBX)**. The PBX is a private telecommunication centre which operates for a single subscriber (e.g. company). The telephone system was installed at the subscriber's place. The technicians followed the instructions in the manual to mount the installation case on the wall, to plug in the modules and interconnect the devices (telephones and PCs). All the instructions could be found in block diagrams and showed the technicians step – by – step what to do. The next step of the installation was to connect the branch to a PC and install the configuration program. During the configuration process the technicians assigned to each internal user an internal number, plus an external number if necessary. The owner of the branch is the one who decides the nature of the settings. The technicians had to 'translate' the owner's wishes and download them into the computer. The skills required in this category were mostly reading, handling and interpreting data. The transformation from 2D to 3D seemed to prove difficult for the technicians, as it required recognition of the conventions that could be seen in the figures of the manuals.

### **Group C: Working in an Earth Satellite Station**

In the third Category the technicians (experts) who work in the Earth Satellite Station were involved in a mathematically rich professional practice. They applied formulas, handled data, interpreted graphs that appeared on the screens of their measuring instruments, and identified the graphs characteristics. For each graph, they checked, if it was to be found in a certain control chart diagram with given standards. Should the process be out of control, they had to interfere. In this group the mathematical objects could be either basic, like ratio, percent, and scale or more advanced like logarithms or statistical concepts. An example of using logarithms was the following. The power level of an amplifier or attenuator, measured in decibels (dB), is defined

as  $n_{dB} = 10 \log_{10} \frac{P_{out}}{P_{in}}$  where  $P_{out}$  is the output power level and  $P_{in}$  is the input power

level. It is common knowledge for the technicians that when the output power level is the half of the input power level, the change of the total power level equals  $-3$  dB, since 10 times the  $\log_{10}(0.5)$  is almost equal  $-3$ .

### **General Strategies - Mathematical processes**

In all three categories, the technicians' main task was fault – finding. The technicians in group A faced a number of situations and took certain decisions. For example, their attempt to localize the fault on a wire would be thwarted by some technical map that would not depict what they found in the reality. So, the technicians had to determine the actual route of the underground wire. In this decision process, they made a series of logical hypotheses and considered where the fault was most likely to occur. This strategy can be described as logical exclusion. Their experience of similar situations was the main source of their decision and gave them the flexibility to doubt the "formal" tool, the map, and to trust their common sense (Pozzi et al, 1998).

Sometimes, they couldn't locate the fault with the first measurement or there were two faults on the same wire so the readings were misleading. In the above situations they followed an iteration method until they located the real problem. They did this by subdividing the wire into two parts and then using the instruments to check in which part the problem lay. This process was repeated until the fault was found. Technicians of all groups used visual inspection to identify a mechanical fault or damage in the device used, or electronic testing with certain specialized instruments. Logical exclusion was also a strategy used by all groups. Another common strategy was that of trial and error. Technicians in group B and C explicitly mentioned a specific algorithmic process of handling break down situations that included visual inspection, electronic testing and interpreting the results. However, solving a problem in the workplace is more complex than just applying a specific strategy or an algorithmic process. The following words of a technician in group C demonstrate this complexity:

“(The device) usually consists of several parts. You take out one part and replace it with another. You turn it on. Does it work? Yes. Okay. If not, you must put that part back and replace it with another one...trying out all those (parts) can be very complicated and could take years, so you must find another way to deal with the problem.”

As indicated above, self – monitoring was also a strategy that was always present as a way to evaluate the appropriateness of a specific action.

### **Beliefs about mathematics and technology**

The technicians in groups A and B did not seem to be aware of the mathematics that they used. In group A, technicians could only recognise as mathematics the arithmetic calculations they made while applying a formula. Only the experts in group C acknowledged that they needed mathematics to better understand their work. They realized that by just following an algorithmic process, without understanding it was not enough, especially in breakdown situations.

“Dealing with the problem can be done mainly in two ways; one is to think theoretically, that is to examine the natural phenomena and perhaps you could examine the mathematical models that describe the phenomena, the other is to ignore these theories and start doing some kind of tests.

Their beliefs about technology concerned two issues that seemed to be apparent in many discussions. One was the impact of technology on their work and the other the role of technological devices. All the groups considered the instruments as an essential part of their work and seemed to trust them. However, the technicians in group A often grounded their decisions on their personal experience and questioned the appropriateness of tools, while the technicians in group C were aware of the need to go more deeply into the way that they operate. A typical response coming from the experts is the following:

“The instruments are my eyes. With the instrument I can see what is happening in my cables. However, it is necessary, for those of us who use these machines, to know how they operate...”

Their opinions about the impact of technology differentiated the three groups. The technicians in group A did not feel that the evolution of technology had an immediate impact on their work, so they felt confident as they could face situations by using their practical wisdom. However, the impact was very apparent to the other two groups. The technicians in group B were forced to constantly update their skills and were struggling to meet the new expectations. Engestrom, (2001) describes these situations as boundary crossing events:

“Ever since I started working in the Organization, I’m always having to learn something new, for how much longer?”

The experts in group C relied on both their theoretical and practical knowledge to face the demands of their job and develop a feeling of security. But even in their case the systems dissimilate numerous mathematical applications. A senior technician with an academic background explained it as follows:

“Mathematics is hiding for practical reasons. No machine would have a practical application if each of its users was supposed to be educated on the whole mathematical theory that had created it”

## **CONCLUDING REMARKS**

The mathematical skills and concepts that the three groups developed, either consciously or not, included basic mathematical ideas from the area of statistics, algebra and geometry. In group A, which was less affected by technological change, mathematics was apparent in many activities. In group B, where the work activities were computer mediated, mathematics was hidden and we could see formalized routines i.e descriptions of how to behave in an algorithmic way similar to the one described by Keitel et al. (1991). In group C, where technology was more advanced and the technicians’ background was academic, mathematics was also apparent and appreciated. It included both basic mathematical ideas and elements of theoretical – abstract thinking while only in this group the artifacts could be considered as tertiary (Cole, 1996). Another point that emerged from our study is that all groups developed general strategies, both mental and experimental, which were essential when facing specific breakdowns. Although similar strategies were met in all groups, the mental strategies were more elaborated in group C. One interpretation could be that the job’s restrictions, and the cost of technological instruments, supported the interplay of both experimental and mental strategies. These emergent strategies could also be as discussed by Wake, Williams & Haighton (2000), a way to bridge the gap between classroom and workplace settings. All the groups trusted technology to a certain degree. The attitude of “trusting the tools without reasoning” seemed to be held mostly in group B while group A in some cases challenged this belief and based their decisions and actions on their practical wisdom. On the other hand, group C trusted the instruments too, but they were also aware of the need to support how they operated theoretically. This finding possibly contributes to the debate between Magajna et al (2003) and Pozzi et al (1998) by recognizing the particularities of the different instruments in relation to the technicians’ academic background.

## References

- Bliss, J. Monk, M. & Ogborn, J. (1983). *Qualitative data analysis for educational research*. London: Croom Helm.
- Cole, M. (1996). *Cultural Psychology. A Once and Future Discipline*. Cambridge: Harvard University Press.
- Daniels, H. (2001). *Vygotsky and Pedagogy*. London: Routledge Falmer.
- Engestrom, Y. (2001). Expansive Learning at Work: toward an activity theoretical reconceptualization. *Journal of Education and Work* 14(1).
- Keitel, C. Kotzmann, E. & Skovsmose, O. (1991). Beyond the Tunnel Vision: Analysing the Relationship Between Mathematics, Society and Technology. In C. Keitel & K. Ruthven *Learning from Computers: Mathematics Education and Technology*. Berlin: Springer-Verlag.
- Magajna, Z. & Monaghan, J. (2003). Advanced Mathematical Thinking in a Technological Workplace. *Educational Studies in Mathematics* 52: 101-122.
- Noss, R., & Hoyles, C. (1996). The visibility of meanings: Modelling the mathematics of banking. *International Journal of Computers for Mathematical Learning*, 1(1), 3-31.
- Pozzi, S., Noss, R., & Hoyles, C. (1998). Tools in practice, Mathematics in use. *Educational Studies in Mathematics*, 36(2), 105-122.
- Rabardel, P. (1995). *Les Hommes et la Technologie: Approche Cognitive des Instruments*. Paris: Armand Colin.
- Straesser, R. (2000). Mathematical means and models from vocational contexts – A German perspective. In A. Bessot & J. Ridgway (Eds.), *Education for Mathematics in the Workplace*. Dordrecht: Kluwer Academic Publishers.
- Wake, G. D., Williams, J. S & Houghton, J. (2000). Spreadsheet mathematics in College and in the workplace: a mediating instrument? In T. Nakahara & M. Koyama (Eds.), *Proceedings of the 24<sup>th</sup> Conference of the International Group for the Psychology of Mathematics Education*, Vol.4, (pp.265-271), Hiroshima University.



# PUPILS' OVER-USE OF PROPORTIONALITY ON MISSING-VALUE PROBLEMS: HOW NUMBERS MAY CHANGE SOLUTIONS

Wim Van Dooren<sup>1,2</sup>, Dirk De Bock<sup>2,3</sup>, Marleen Evers<sup>2</sup>, and Lieven Verschaffel<sup>2</sup>

<sup>1</sup> Postdoctoral Fellow of the Research Foundation, Flanders

<sup>2</sup> Center for Instructional Psychology and Technology, University of Leuven, Belgium

<sup>3</sup> European University College Brussels, Belgium

*This study builds on previous research showing that primary school pupils over-use proportional methods when solving non-proportional missing-value word problems. It is hypothesized that when the numbers in word problems form integer ratios, this will stimulate pupils to apply proportional methods, even if this is inappropriate. It is furthermore expected that the effect will diminish from grade 4 to 6 (with pupils' age and proportional reasoning experience). The results confirm both hypotheses.*

## THEORETICAL AND EMPIRICAL BACKGROUND

Contemporary math education curricula consider it important that pupils can model real-world problem situations. In primary school such applied problem solving traditionally is taught through word problems (Verschaffel, Greer, & De Corte, 2000). Recently, however, it was found that pupils start to perceive word problem solving as a puzzle-like activity with little grounding in the real world. One of the problems is that pupils can often successfully use superficial cues to decide upon the required operations to solve word problems in textbooks or tests. Arguably, this does not lead to a disposition to discriminate between problems that can and cannot be modelled and solved by means of straightforward arithmetical operations, but rather to a tendency to cope with all problems in a stereotyped and superficial way.

A clear example is that pupils tend to over-use proportional methods. Proportionality is a major topic in primary and secondary math education. Typically, from 4<sup>th</sup> grade on, pupils are increasingly confronted with missing-value proportionality problems. Studies indicate that pupils associate such problems with the proportionality scheme, even when this is not appropriate (De Bock, Verschaffel, & Janssens, 2002). For example, more than 90% of 10-12-year olds answer "170 seconds" to the following item: "John's best time to run 100 metres is 17 seconds. How long will it take him to run 1 kilometre?" (Verschaffel et al., 2000). Or more than 80% of 12-16-year old pupils give proportional answers to geometry problems like "Farmer Gus needs 8 hours to fertilise a square pasture with sides of 200 metres. How much time will he approximately need to fertilise a square pasture with sides of 600 metres?" (answering "24 hours" in this case) (De Bock et al., 2002; Modestou, Gagatsis, & Pitta-Pantazi, 2004). But also upper secondary and even university students over-use proportionality in various domains like probability (Van Dooren, De Bock, Depaepe, Janssens, & Verschaffel, 2003) or calculus (Esteley, Villarreal, & Alagia, 2004).

In a recent study (Van Dooren, De Bock, Hessels, Janssens, & Verschaffel, 2005), we determined when the tendency to routinely apply proportional methods originates, and how it develops with pupils' increasing age. We analysed large numbers of 3<sup>rd</sup> to 8<sup>th</sup> graders' solutions to various proportional and non-proportional arithmetic problems. An example of a proportional problem used in that study is: "*In the shop, 4 packs of pencils cost 8 euro. The teacher wants to buy 24 packs. How much does she have to pay?*" An example of a non-proportional problem is "*Ellen and Kim are running around a track. They run equally fast, but Ellen started later. When Ellen has run 5 rounds, Kim has run 15 rounds. When Ellen has run 30 rounds, how many has Kim run?*" (proportional answer:  $5 \times 3 = 15$  rounds, so  $30 \times 3 = 90$  rounds, correct answer:  $5 + 10 = 15$  rounds, so  $30 + 10 = 40$  rounds). We found that the number of correct answers on the proportional problems considerably increased with age, from 53% in 3<sup>rd</sup> grade to 93% in 8<sup>th</sup> grade, with most learning made between 3<sup>rd</sup> and 5<sup>th</sup> grade. But the tendency to *over-use* proportional methods initially developed in parallel with pupils' emerging proportional reasoning skills. In 3<sup>rd</sup> grade, 30% of all non-proportional problems were answered proportionally, and this increased until 51% in 5<sup>th</sup> grade (with a decrease thereafter to 22% in 8<sup>th</sup> grade). We concluded that at the moment when they acquire proportional reasoning skills as a result of their training in solving 'typical' proportionality problems, pupils tend to overgeneralise proportional methods and learn to apply them on the basis of superficial problem characteristics, like the missing-value format of word problems.

## PROPORTIONAL REASONING: HOW NUMBERS AFFECT SOLUTIONS

Despite the evidence for the over-use of proportional methods in various mathematical domains as documented by research worldwide, there is one – possibly important – issue that has been largely overlooked in that research so far: the *nature of the numbers* in the non-proportional problems, and the possible impact of these numbers on pupils' tendency to use proportional methods to these problems.

The issue can be clarified by considering the literature on proportional reasoning. A frequently reported error on missing-value proportionality tasks (e.g., Hart, 1984; Karplus, Pulos, & Stage, 1983) is the so-called 'constant difference' or 'additive' strategy, in which the relationship within the ratios is computed by subtracting one term from a second, and then the difference is applied to the other ratio (instead of considering the multiplicative relationship). For example, "Mixture A has 2 oranges for 6 parts of water. Mixture B tastes the same and has 10 oranges. This is  $10 - 2 = 8$  oranges more, so it needs  $6 + 8 = 14$  parts of water". The most prominent explanation for this error is that it is a kind of 'fall-back' strategy (especially for less skilled proportional reasoners) to deal with proportional problems with non-integer ratios, like in the problem "One mixture has 2 oranges to 7 parts of water. Another mixture tastes the same and has 5 oranges. How many parts of water does it have?" (See, e.g., Karplus et al., 1983, who call this the 'fraction avoidance syndrome').

In sum, correct reasoning on proportional (missing-value) tasks sometimes is affected by the nature of the numbers. Particularly less skilled proportional reasoners perform

worse if ratios in proportional problems are non-integer. The claim underlying the present study is that this also applies to the use of proportional methods to solve *non-proportional* problems. The non-proportional problems in many of the above-mentioned studies (e.g., De Bock et al., 2002; Van Dooren et al., 2003, 2005; Verschaffel et al., 2000) contained ‘easy’ numbers: Both the internal and the external ratio were integer, so although the problems had no proportional structure, the given numbers somehow invited pupils to conduct proportional calculations. Linchevski, Olivier, Sasman, and Liebenberg (1998) found some indications that such integer ratios could ‘trigger’ unwarranted proportional reasoning, but they did not systematically test this hypothesis. They concluded that “it remains a question for further research to establish whether an approach with non-seductive numbers will *prevent* children from making the multiplication error” (p. 222). So while non-integer ratios cause more errors on proportional problems, they may have an opposite impact in non-proportional problems, as pupils may be less inclined to over-use proportional methods when confronted with non-integer ratios. The goal of this paper is to test this hypothesis, and in this way, to gain further insight in the determinants of pupils’ tendency to over-use proportional methods.

## METHOD

508 4<sup>th</sup>, 5<sup>th</sup> and 6<sup>th</sup> graders from 5 randomly chosen Flemish primary schools participated in this study. They received a test containing 8 missing-value word problems presented in random order. The problems were identical to those used by Van Dooren et al. (2005). The design of the test is shown in Table 1 and examples of word problems are given in the left column of Table 2. The test contained one type of *proportional* problems (for which proportional strategies provide the correct answer) and 3 types of *non-proportional* problems (for which another strategy must be applied to find the correct answer). The 3 types of non-proportional problems had different mathematical models underlying them: additive, constant and affine (i.e., a model of the form  $f(x) = ax + b$ ). For each category, 2 items were included.

	Item I	Item II
<b>Proportional (PR)</b>	1	2
<b>Non-proportional</b>		
Additive (AD)	3	4
Constant (CO)	5	6
Affine (AF)	7	8

Table 1: Design of test items

Central to this study was that the numbers in the word problems were experimentally manipulated, as clarified in Table 2. The manipulation was such that when focussing on the ratios between the numbers, one ends up either with integer (I) ratios or with non-integer (N) ratios. This manipulation led to 4 different versions of each item:

- **II**-version: external ratio ( $a/b$ ) integer and internal ratio ( $a/c$ ) integer
- **NI**-version: external ratio ( $a/b$ ) non-integer but internal ratio ( $a/c$ ) integer
- **IN**-version: external ratio ( $a/b$ ) integer but internal ratio ( $a/c$ ) non-integer
- **NN**-version: external ratio ( $a/b$ ) non-integer and internal ratio ( $a/c$ ) non-integer

For example, the II-version of the additive (AD) word problem in Table 2 was:

Ellen and Kim are running around a track. They run equally fast but Ellen started later. When Ellen has run 16 rounds, Kim has run 32 rounds. When Ellen has run 48 rounds, how many rounds has Kim run?

A correct reasoning for this II-version is to focus on the (constant) difference between the numbers: *Kim is initially running 16 rounds ahead of Ellen. This remains the same, so when Ellen has 48 rounds, Kim has  $48 + 16 = 64$  rounds.* When reasoning proportionally here (which is inadequate, of course), one needs to focus on the ratios between the numbers: either on the external ratio  $a/b$  (*initially, Kim has twice as many rounds as Ellen ( $32/16$ ), so when Ellen has 48 rounds, Kim has  $48 \times 2 = 96$  rounds*), or on the internal ratio  $a/c$  (*at the end, Ellen has 3 times as many rounds as initially ( $48/16$ ), so by that time, Kim has  $32 \times 3 = 96$  rounds*). For the NN-version of the same word problem, the correct approach is comparably easy (only the constant difference to work with differs). Proportional reasoning, however, is considerably more complex here, because both the internal and external ratio are non-integer: The multiplicative ‘jump’ from 16 to 24 is far less evident than that from 16 to 32, but for a skilled proportional reasoner, it is still feasible. Reasoning proportionally for the NN-version might be, for example: *initially, Kim has  $3/2$  times as many rounds as Ellen, so when Ellen has run 36 rounds, Kim has run  $36 \times 3/2 = 54$  rounds.*

The tests were manipulated so that – at a random basis – 2 of the 8 word problems were in the II-version, 2 in the NI-version, 2 in the IN-version and 2 in the NN-version. Pupils’ answers to the problems were classified as either *correct* (C, correct

Example of word problem		Numbers and solutions for each version <sup>a</sup>			
		II	NI	IN	NN
PR	In the shop, <i>a</i> packs of pencils cost <i>b</i> euro. The teacher wants to buy <i>c</i> packs. <i>How much</i> does she have to pay?	9 27 18 <b>C: 54</b>	9 24 18 <b>C: 48</b>	9 27 12 <b>C: 36</b>	9 24 12 <b>C: 32</b>
		AD	Ellen and Kim are running around a track. They run equally fast but Ellen started later. When Ellen has run <i>a</i> rounds, Kim has run <i>b</i> rounds. When Ellen has run <i>c</i> rounds, <i>how many</i> has Kim run?	16 32 48 <b>C: 64</b> <b>P: 96</b>	16 24 48 <b>C: 56</b> <b>P: 72</b>
CO	A group of <i>a</i> musicians plays a piece of music in <i>b</i> minutes. Another group of <i>c</i> musicians will play the same piece of music. <i>How long</i> will it take this group to play it?	25 75 50 <b>C: 75</b> <b>P: 150</b>	25 40 50 <b>C: 40</b> <b>P: 80</b>	25 75 35 <b>C: 75</b> <b>P: 105</b>	25 40 35 <b>C: 40</b> <b>P: 56</b>
		AF	The locomotive of a train is $12^b$ m long. If there are <i>a</i> carriages connected to the locomotive, the train is <i>b</i> m long in total. If there would be <i>c</i> carriages connected to the locomotive, <i>how long</i> would the train be?	4 44 8 <b>C: 76</b> <b>P: 88</b>	4 42 8 <b>C: 74</b> <b>P: 84</b>

<sup>a</sup> Numbers are schematically represented as  $a \ b$   
 $c \ x$  (C: correct solution, P: proportional solution)

<sup>b</sup> For the NI and NN-version, this value was 10

Table 2: Examples of word problems and manipulation of numbers in the II-, NI-, IN-, and NN-versions

answer was given), *proportional error* (P, proportional strategy applied to a non-proportional item) or *other error* (O, another solution procedure was followed).

## HYPOTHESES

Due to space restrictions, we limit ourselves to comparing the ‘extreme’ versions of the proportional and non-proportional items, i.e., the II- and NN-versions with, respectively, *both* (internal and external) ratios integer and *no* ratios integer.

A first set of hypotheses relates to pupils’ performances on the *proportional problems*. Based on the proportional reasoning literature, we expect proportional problems with non-integer ratios (NN-version) to cause more errors (i.e., less correct (C) answers) than proportional problems with integer ratios (II-version) (**HYP 1A**). We anticipate this effect will be stronger in younger, less experienced proportional reasoners, so the different performance on the II- and NN-versions will be most pronounced in 4<sup>th</sup> grade, and gradually diminish through 5<sup>th</sup> and 6<sup>th</sup> grade (**HYP 1B**).

The second set of hypotheses deals with the *non-proportional word problems*. As argued above, we expect that problems with non-integer ratios (NN-version) will elicit less unwarranted proportional (P) answers than problems with integer ratios (II-version) (**HYP 2A**). We expect that particularly for the additive items (AD), the decrease in P-answers will result in more correct (C) answers – because the ‘additive’ strategy that pupils often *erroneously* apply to non-integer proportional problems is exactly the *correct* strategy for AD-items –, whereas for the constant (CO) and affine (AF) items, it might as well result in more other errors (O-answers) (**HYP 2B**). Finally, as for the proportional items, we expect that differences on the NN- and II-versions of the non-proportional items will be the strongest in the 4<sup>th</sup> graders, and will gradually diminish through 5<sup>th</sup> and 6<sup>th</sup> grade (**HYP 2C**).

## MAIN RESULTS

Table 3 shows the percentage of correct answers to the *proportional problems*. As expected (**HYP 1A**), the NN-versions of the proportional problems elicited less correct answers (56.8%) than the II-versions (82.1%). A repeated measures logistic regression analysis showed that this difference was significant, as there was a main effect of ‘number type’,  $\chi^2(1, N = 508) = 52.51, p < .0001$ .

The analysis also reveals a ‘number type’ × ‘grade’ interaction effect,  $\chi^2(2, N = 508) = 166.59, p < .0001$ . In line with **HYP 1B**, the difference between the II- and NN-version was very strong in 4<sup>th</sup> grade (65.2% correct answers to the II-version and only 23.6% on the NN-version), less strong but still significant in 5<sup>th</sup> grade (with 86.3% and 63.8% correct answers, respectively), and not significantly different in 6<sup>th</sup> grade (96.4% and 85.5% correct answers, respectively).

	4 <sup>th</sup> grade	5 <sup>th</sup> grade	6 <sup>th</sup> grade	Total
II	65.2	86.3	96.4	82.1
NN	23.6	63.8	85.5	56.8

Table 3: % correct answers on the proportional problems in the II- and NN-version

In Table 4 we have split up the results for the 3 different types of *non-proportional*

problems. It shows that the NN-versions elicited considerably less P-answers than the II-versions, and this was true for each type of non-proportional problem. For the additive (AD) problems, the II-versions elicited 29.3% P-answers, and the NN-versions only 12.3%,  $\chi^2(1, N = 508) = 23.41, p < .0001$ . For the constant (CO) items, the II-version elicited 61.7% P-answers vs. 36.0% in the NN-version,  $\chi^2(1, N = 508) = 34.03, p < .0001$ . Finally, for the affine (AF) items, percentages were 56.6% and 34.4%, respectively,  $\chi^2(1, N = 508) = 31.54, p < .0001$ . So **HYP 2A** was confirmed.

Table 4 suggests that also **HYP 2B** was confirmed:

- For the AD-items, the decrease of P-answers resulted in an increased number of C-answers: The II-versions got only 51.6% C-answers whereas the NN-versions got 73.0%,  $\chi^2(1, N = 508) = 24.71, p < .0001$ , while there was no significant difference in the number of O-answers (19.0% and 14.7% respectively).
- For the CO- and AF-items, the decrease in the number of P-answers led to a significantly higher number of O-answers: For the CO-items, there is an increase from 29.7% to 52.0%,  $\chi^2(1, N = 508) = 25.99, p < .0001$ , and for the AF-items, the increase is from 21.5% to 44.5%,  $\chi^2(1, N = 508) = 33.82, p < .0001$ . No significant differences are found in the number of C-answers, neither for the CO-items (8.6% and 12.1%), nor for the AF-items (21.9% and 21.1%).

Finally, **HYP 2C** was confirmed too: The differences in the number of P-answers to the NN- and II-versions were the largest in the 4<sup>th</sup> graders. In 5<sup>th</sup> and especially 6<sup>th</sup> grade, differences were considerably smaller, or even completely gone:

- AD-items: The ‘number type’ × ‘grade’ interaction effect for P-answers,  $\chi^2(2, N = 508) = 25.19, p = .0003$ , indicates that 4<sup>th</sup> graders gave significantly more P-answers to the II-variant (23.6%) than to the NN-variant (0.0%). The difference was still present in 5<sup>th</sup> grade (35.0% vs. 12.5%), but 6<sup>th</sup> graders gave almost equal numbers of P-answers to the II- and NN-variant (30.1% vs. 25.3%).
- CO-items: A similar ‘number type’ × ‘grade’ interaction effect was found,  $\chi^2(2, N = 508) = 40.60, p < .0001$ : In 4<sup>th</sup> grade, the II-variant elicited much more P-answers (57.4%) than the NN-variant (8.1%). In 5<sup>th</sup> grade the difference was smaller but still significant (63.0% vs. 38.3%), but in 6<sup>th</sup> grade, the difference had disappeared (with 64.8% and 61.3% P-answers, respectively).

		4 <sup>th</sup> grade			5 <sup>th</sup> grade			6 <sup>th</sup> grade			Total		
		C	P	O	C	P	O	C	P	O	C	P	O
AD	II	57.3	23.6	19.1	48.8	35.0	16.2	48.1	30.1	21.7	51.6	29.3	19.0
	NN	80.9	0.0	19.1	68.8	12.5	18.8	68.7	25.3	6.0	73.0	12.3	14.7
CO	II	6.9	57.4	35.6	13.6	63.0	23.4	5.7	64.8	30.0	8.6	61.7	29.7
	NN	17.2	8.1	74.7	12.4	38.3	49.4	6.8	61.3	31.8	12.1	36.0	52.0
AF	II	13.8	54.0	32.2	23.5	54.3	22.2	28.4	61.4	10.2	21.9	56.6	21.5
	NN	12.6	12.6	74.7	18.5	38.3	43.2	31.8	52.3	15.9	21.1	34.4	44.5

Table 4: % correct, proportional and other answers on the non-proportional problems in the II- and NN- version

- AF-items: Again, a ‘number type’  $\times$  ‘grade’ interaction effect,  $\chi^2(2, N = 508) = 32.83, p < .0001$ , showing a large difference in P-answers in 4<sup>th</sup> grade (54.0% on the II-variant vs. 12.6% on the NN-variant), a smaller difference in 5<sup>th</sup> grade (54.3% vs. 38.3%), and a non-significant difference in 6<sup>th</sup> grade (61.4% vs. 52.3%).

## CONCLUSIONS AND DISCUSSION

Earlier studies convincingly showed that pupils of various ages tend to apply proportional methods to solve various kinds of missing-value word problems, even when this is not appropriate. Remarkably, the problems in these studies always comprised ‘easy’ numbers (i.e., the internal and external ratio were integer). Some researchers have argued that this may have ‘triggered’ unwarranted proportional reasoning. The current study explicitly addressed this claim by experimentally manipulating the integer or non-integer character of the ratios in the word problems.

The results on the proportional problems replicated those reported in the proportional reasoning literature: Problems with non-integer ratios elicited less correct answers than variants with integer ratios. Moreover, this effect was particularly strong in 4<sup>th</sup> grade, and became less influential in 5<sup>th</sup> and especially 6<sup>th</sup> grade. With respect to the non-proportional problems, our findings confirmed the hypothesis that pupils are less inclined to over-use proportional methods when the given numbers do not form integer ratios. In line with our expectations, the decrease of unwarranted proportional answers resulted in better performances on problems with an additive structure, as the ‘additive strategy’ – which is often erroneously applied on non-integer proportional problems – is correct for solving this kind of word problems. For constant and affine word problems the decrease in proportional answers did not result in better performances, as pupils started to commit more other errors. Finally, we also found, as expected, that 4<sup>th</sup> graders were particularly sensitive to the presence of non-integer ratios in non-proportional problems, whereas 5<sup>th</sup> and especially 6<sup>th</sup> graders were hardly or not affected by it.

Although the scope of this study was microscopic, it has some broader theoretical, methodological and practical implications. *Theoretically*, it further documents the variety of superficial cues pupils rely on when doing word problems (Sowder, 1988): Not only problem formulations or key words, but also particular number combinations can be associated with certain solution methods (here, proportional methods). This association moreover interacts with pupils’ mathematical knowledge: For more experienced proportional reasoners, a missing-value format is a ‘sufficient condition’ to apply proportionality, whereas for less experienced pupils the ‘necessary condition’ is that the numbers have an integer multiplicative structure. *Methodologically*, our study warns against assessing the over-use of proportionality merely using problems having an integer multiplicative structure (like, e.g., in Van Dooren et al., 2005). Nevertheless, this warning only seems to hold for the assessment of younger, less experienced proportional reasoners. *Practically*, our results suggest that the classroom teaching of proportionality might benefit from explicitly discussing the criteria that pupils use (or do not use) when deciding on the appropriateness of proportional solution methods.

## References

- De Bock, D., Verschaffel, L., & Janssens, D. (2002). The effects of different problem presentations and formulations on the illusion of linearity in secondary school students. *Mathematical Thinking and Learning*, 4, 65–89.
- Esteley, C., Villarreal, M., & Alagia, H. (2004). Extending linear models to non-linear contexts: An in-depth study about two university students' mathematical productions. In M. J. Høines & A. B. Fuglestad (Eds.), *Proceedings of the 28<sup>th</sup> PME Conference* (Vol. 2, pp. 343–350). Bergen, Norway.
- Hart, K. (1984). *Ratio: Children's strategies and errors*. Windsor, UK: NFER Nelson.
- Karplus, R., Pulos, S., & Stage, E. (1983). Proportional reasoning of early adolescents. In R. Lesh & M. Landau (Eds.), *Acquisition of mathematical concepts and processes* (pp. 45–89). New York: Academic Press.
- Linchevski, L., Olivier, A., Sasman, M., & Liebenberg, R. (1998). Moments of conflict and moments of conviction in generalising. In A. Olivier & K. Newstead (Eds.), *Proceedings of the 22<sup>nd</sup> PME Conference* (Vol. 3, pp. 215–222). Stellenbosch, South Africa.
- Modestou, M., Gagatsis, A., & Pitta-Pantazi, D. (2004). Students' improper proportional reasoning: The case of area and volume of rectangular figures. In M. J. Høines & A. B. Fuglestad (Eds.), *Proceedings of the 28<sup>th</sup> PME Conference* (Vol. 3, pp. 345–352). Bergen, Norway.
- Sowder, L. (1988). Children's solutions of story problems. *Journal of Mathematical Behavior*, 7, 227–238.
- Van Dooren, W., De Bock, D., Depaepe, F., Janssens, D., & Verschaffel, L. (2003) The illusion of linearity: Expanding the evidence towards probabilistic reasoning. *Educational Studies in Mathematics*, 53, 113–138.
- Van Dooren, W., De Bock, D., Hessels, A., Janssens, D., & Verschaffel, L. (2005). Not everything is proportional: Effects of age and problem type on propensities for overgeneralization. *Cognition and Instruction*, 23(1), 57–86.
- Verschaffel, L., Greer, B., & De Corte, E. (2000). *Making sense of word problems*. Lisse: Swets & Zeitlinger.



# ARITHMETICAL PROCEDURES IN THE SOLUTION OF A PROBLEM INVOLVING VELOCITY

Verónica Vargas

Cinvestav-IPN y CIDEM, México

José Guzmán

Cinvestav-IPN, México

*In this article we report the detailed analysis of the procedures employed by a group of high school students in approaching a verbal algebraic problem involving velocity. This is a part of a sequence of 17 problems of rate that were implemented in the classroom utilizing paper and pencil environment, with the end of promoting the evolution of algebraic thought in high school students. The results demonstrate that these students, in spite of having previously assisted in algebra courses, continue to use arithmetical type procedures in their solution processes, and from this we suggest that it is necessary to place more emphasis on the multiplicative relations in the practice of teaching.*

## INTRODUCTION

The work of translating between natural language and algebraic language is a challenge for pre-algebraic students (Malara, 1999). Even when they are able to identify the relationships between the elements of a given problem, there exists the difficulty of expressing themselves in an algebraic code. In other words, the students do not know how to relate that code with the semantics of natural language (Bazzini, 1999).

In this article we report in detail on the procedures used by a group of high school students in approaching a verbal algebraic problem (we will say single problem) involving velocity. The problem analyzed was part of a larger investigation working with a sequence of 17 problems of *rate* that were implemented in the classroom for the solution of problems, with the proposition of promoting the evolution of algebraic thought in the high school students. An addition, we propose to answer the questions: How do high school students perform in the confrontation of problems involving velocity? What are their procedures for solution? What type of thought processes are characterized by the students in the use of those procedures?

The analysis of the procedures employed in the solution of the problem was based on research carried out by Bednarz & Janvier (1994, 1996) and Vergnaud (1991).

## Literature Review

Bednarz & Janvier (1994, 1996) proposed a theoretical tool (*grille d'analyse*) that permits the classification of word problems utilized in the teaching and learning of arithmetic and algebra. One of the three classes of problems that were identified were those of *rate* which involved a relationship of comparison between non-homogenous magnitudes. Problem 1 is an example of this type; we can observe two

non-homogenous magnitudes (distance and time) related through a *rate* (velocity). The symbolism created by these authors to sustain their theory is described in Guzmán, Bednarz & Hitt (2003, p. 11).

Bednarz & Janvier (1996) defined the characteristics that determine the difference between an arithmetical problem and an algebraic one. The algebraic, or disconnected, problems were characterized by the difficulty presented in establishing direct *bridges* between the known quantities. These must be operated with various unknown quantities at the same time, making it necessary to establish equations in order to solve them (Figure 1). On the other hand, it is possible to solve a *connected* problem using the given data by “progressive negation of cases”. That is to say, in these problems it is possible to construct *bridges* between the known states and relationships to obtain the unknown states and relationships. In general, in this way the arithmetical procedures are organized according to the processing of known quantities. The students create unions between these and finalize the operations; the unknown quantities are left until the end of the process.

From the above, we can derive the characteristics of algebraic thought or a typical profile of a solver.

- Knowledge of patterns (regularities). The reading of the problem (knowledge of the quantities involved in the problem as well as the relationship between them) and the resources which occur to the student in order to understand it are the essential elements of this phase.
- Establishment of conjectures. The phase of formation of a mental representation that interprets the information given in the problem and transforms it into objects with its associated properties, organizing the relationships between these objects and representing the relationships through equations.
- Symbolic manipulation. The phase of solving equations which requires the knowledge of manipulating them.

The comprehension and management of the basic elemental operations are essential in algebraic thought. The multiplicative relationships (multiplication or division), and in particular the relationships among four quantities (Vergnaud, 1991) underlie the structure of many arithmetical and algebraic problems. These relationships occur among four quantities, two quantities of a certain type (for example kilometers), and the others of another type (for example, minutes). Vergnaud (1991) proposed schemes of tables of correspondence in order to analyze the complexity of problems that involve relationships among four quantities and made an analysis of the type of operations that the student could do. This author placed emphasis on two types of operations, scalar and functional, and suggested that for the students, whose thought is arithmetic, the functional operations were of higher complexity, given that these

involve not only the notion of the numerical relationship but of the knowledge of dimensions.

### Methodology

In this article we discuss the procedures followed by a group of students toward the following problem involving velocity.

Problem 1. The highway that connects cities A and B, from A towards B, goes up- and then downhill. A bicyclist, whose average velocity is  $10\text{ km/h}$  on the rise and  $30\text{ km/h}$  going downhill, takes an hour and 30 minutes to get from A to B and two hours and 30 minutes to get from B to A. Calculate the distance to each of the cities from the highest point of the route. (Bednarz *et al.*, 2003, p. 13.)

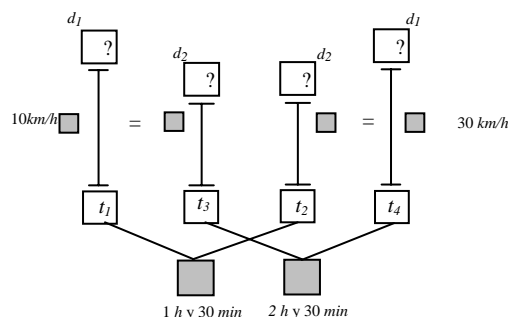

Figure 1. Scheme of the Problem 1. This type of scheme was explained by Guzmán *et al.* (2003).

Figure 1 shows the scheme of the structure of the problem, taking as reference the theoretical tool of Bednarz & Janvier (1996). The *rate* is velocity ( $\text{km/h}$ ). This *rate* relates the two non-homogenous quantities of distance and time.

The problem was implemented in a school which is part of a technical public high school in the state of Michoacan, Mexico. The group was comprised of 45 students who were in their first semester. They were selected for being at the end of their semester of algebra, which is in the first semester of high school. Because of this, their basic knowledge in this discipline corresponded to their algebra course in secondary and high school.

In a work session in the classroom the group in the study, made up of teams of three students, was given Problem 1. They were given approximately 30 minutes to solve the problem, followed by a group discussion of the solution procedures employed. The session ended with a general presentation by the group of the results obtained and the discussion of the procedures of solution. This session of the work in the classroom was both video taped and audio taped.

Discussion of the solution of Problem 1. This problem is not connected or algebraic, in Bednarz & Janvier's (1996) terms. The possible diagrams (the meaning of the diagram is used in a different manner that that of the scheme by Bednarz & Janvier, 1996) that were represented are the following.

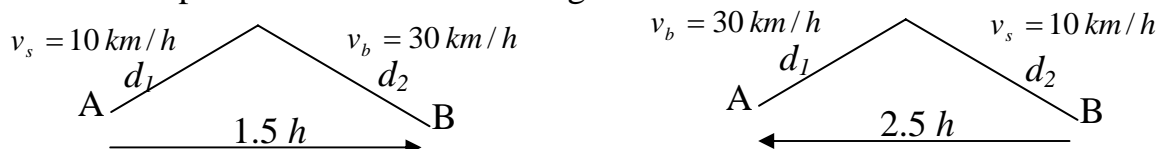

Figure 2. Diagrams representative of Problem 1. The data of an hour and 30 minutes is represented as  $1.5\text{ h}$ .

This problem can be solved in an algebraic manner by writing and solving a system of equation such as the following  $\begin{cases} t_1 + t_2 = 1.5 \\ t_3 + t_4 = 2.5 \end{cases}$  which involve the relationship  $v = \frac{d}{t}$ ,

where  $t_i$  ( $i = 1, 2, 3, 4$ ) represents the times required by the bicyclist for both segments of the trip. The system of preceding equations could be transformed to:

$$\begin{cases} \frac{d_1}{10} + \frac{d_2}{30} = 1.5 \\ \frac{d_2}{10} + \frac{d_1}{30} = 2.5 \end{cases} \quad \text{Where } d_1 \text{ represents the distance from A to the highest point of the}$$

highway and  $d_2$  represents the distance to the highest point in the highway. When solving this system of equations the solution is  $\begin{cases} d_1 = 7.5 \\ d_2 = 22.5 \end{cases}$  in kilometers.

The solution to this problem cannot be determined through arithmetic procedures as the problem is disconnected. However, if a solver makes connections by trial and error it is possible to come to a solution. One possible form to make the connection is the following. Propose a value for  $t_1$  (Figure 3) and employ this to calculate the values of  $t_2$  (through the relationship of  $t_1 + t_2 = 1.5$ ) and of  $d_1$  (through the relationship of  $v = \frac{d}{t}$ ); then calculate  $d_2$ ,  $t_4$  and  $t_3$ . These last values serve to verify the relationship of  $t_3 + t_4 = 2.5$ .

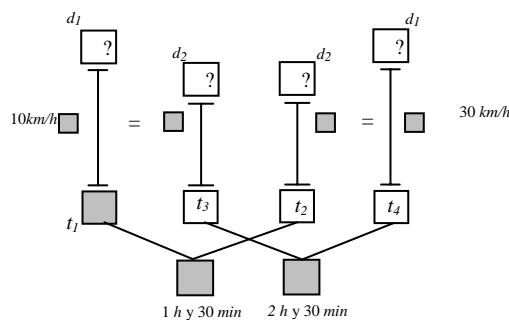

Figure 3. Scheme of the structure of Problem 1, after making connections.

Numerical example, utilized in the scheme in Figure 3. Given that the time taken for the cyclist in the run from A to B is one hour and 30 minutes, it can be supposed that one hour is the time taken to go from A to the highest point on the highway (P) and 0.5 hours is the time taken to go from the highest point (P) to B (Figure 4a).



Figure 4. Diagram representative of Problem 1. In (a) numerical values have been assigned to the times of the trip from A to P and from P to B and in (b) is shown the values obtained for the distances asked.

With these values and considering the relationship of  $v = \frac{d}{t}$ , the distances from A to P and from P to B are calculated as 10 km and 15 km, respectively (Figure 4b), which can be verified by using them to calculate the times taken by the cyclist in the return to B from A. In this case, the times taken by the cyclist from B to P and from P to A are 0.33 hours and 1.5 hours, respectively, whose sum is not the hoped for one of 2.5 hours. Because of this, the process must be reinitiated; students have to suppose other values for the times taken by the cyclist to make the distances from A to P and from P to B in order to obtain 2.5 hours.

We hoped to observe these two solution process, the algebraic and the arithmetical, in the procedures of solution used by the students, primarily the algebraic.

### Results and discussion

Half of the group of students attempted to solve the problem through the formulation of a system of equations but none successfully established in a correct manner the equations because it was not clear to them how to relate the involved quantities in the problem; they did not encounter an adequate representation of the variables in question.

The other groups of students attempted to solve the problem through arithmetic. The majority of them did not succeed. Only one group successfully solved the problem in the correct manner. The first phase of the solution process of this group consisted in the knowledge of the known and unknown quantities of the problem (Figure 5). Represented therein is part of the information given in the problem. Following this they converted the hour and a half used by the cyclist to go from A to B into 90 minutes.

The second phase consisted in making conjecture. The team of students set out the need to know the times that were taken by the cyclist to go the distances from A to the highest point of the highway, and from this point to B; because of this, they divided 90 minutes by two and considered that the cyclist took 45 minutes to go from both sections. This permitted them to connect (Figure 3) the problem. Here is the explication that the speaker for the group gave to the rest of the class with respect to the solution process that had been utilized.

- 1 I: What group wishes to make their presentation?
- 2 S1: We do. (*A student from the group went to the board with one of the papers on which were written the procedures –Figure 5– and began to draw a diagram without saying anything. The others waited for the explanation while watching and making commentaries. Some were following what the student was writing. There was a lot of noise in the classroom.*)
- 3 I: We must pay attention to see how they solved the problem.
- 4 S1: Here what we did was to divide the hour and a half (*the student began to speak, but as the noise continued in the classroom the explanation could not be heard, and he was asked to start over.*)
- 5 I: (*Interrupting the speaker*) We cannot hear you at the back.

- 6 S1: (*Raising his voice*) We divided the hour and a half that it took from A to B (*pointing with his finger to points A and B of the diagram*) and this gave us 45 minutes to go uphill and 45 minutes to go downhill (*pointed again towards the diagram of the rise and fall of the highway and continued the explication*). Then we saw that so many kilometers were travelled in 45 minutes on the rise and this gave us 7.5 kilometers, and going downhill there were 22.5 kilometers and then the reverse the 22.5 kilometers gave us 2.15 hours on the uphill part...
- 7 S2: Hey (*an expression trying to confirm what was said by his classmate*), and going downhill (*this student, apparently, following the explication of his classmate*).
- 8 S1: and the 7.5 kilometers (*uphill*) give 15 minutes, and thus it was as we obtained it...um, 45 and 45 are an hour and a half from A to B. The 15 others the two hours and 15 minutes gave us the two hours and a half.
- 9 S: Oh, ah (*There were many doubts as much on the part of the students as on that of the researcher. However, they permitted Student 1 to finish his explanation. Also, this student did not pay attention to the questions of his classmates because he was concentrating on explaining in a summary manner the solution process*).
- 10 S1: In other words, there are two (*made a mistake and corrected it*), six minutes taken per kilometer uphill [...] (*The student continued talking but the other students started to repeat what he was saying, trying to follow his explanations in order to understand them and stopped listening to him.*)
- 11 I: (*Interrupting the student's speech*) Where did the six minutes [...] per kilometer come from?
- 12 S1: We divided the 60 minutes of an hour by the 10 kilometers of the uphill part and...
- 13 S1: 60 by 10 kilometers, 60 minutes by the 10 kilometers gives 6 minutes (he had difficulty with the dimensions. In reality, the only thing that was controlled was the operations with the numerical quantities. The relationships of the dimensions were not being made, and because of this he at times mentioned minutes and at times did not, and the same was done with the kilometers.)

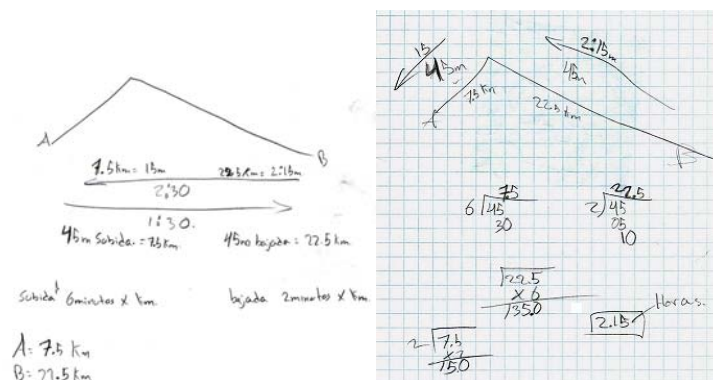

Figure 5. Solution procedures of Problem 1 utilized by a group of students.

Figure 5 illustrates the diagram in which the previous explanation was based, but the diagram utilized for this was a reinterpretation of the registered process done with pencil and paper to solve Problem 1.

Continuing with the discussion of the procedures, the team of students employed the relation of equivalence of one hour and 60 minutes to find what distance the cyclist covered in a certain quantity of minutes. The reasoning can be explained using correspondence table of Vergnaud (1991) between kilometers and minutes (Figure 6).

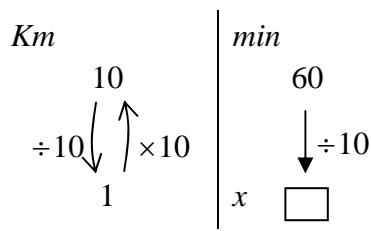

Figure 6. Table of Correspondence between two types of quantities: kilometers and minutes.

The team of students parted from the link of correspondence between the 10 kilometers and the 60 minutes and looked for a unitary value. But they did not decide to look for so many kilometers for each minute taken by the cyclist but for so many minutes taken by the cyclist to cover 1 kilometer. Here intervened the notion of division, 60 was divided by 10, in order to show the vertical relationship from high to low (Figure 6) in the left column. The operator  $\div 10$  is a scale operator that reproduces in the right column what occurs in the left, which expresses the change from 10 km to 1 km and is the inverse operator of the operator  $\times 10$ , which permits the change from 1 km to 10 km. The students did not think in terms of horizontal operators (functions) that would permit the change from kilometers to minutes but in terms of vertical operators (scalar). According to Vergnaud (1991), to finalize horizontal operations requires a level of complexity higher than to finalize vertical operations and is, additionally, the reason for the difficulties encountered in helping the student understand the notion of function.

Knowing that the cyclist took 6 minutes to cover 1 kilometer when going uphill and 2 minutes to cover 1 kilometer when going downhill permitted the students to calculate how much time, in minutes, it took the cyclist on the up- or downhill distances, which helped to find the distance that the cyclist covered in 45 minutes of both up- and downhill travel, 7.5 km and 22.5 km respectively. The team of students finalized the operations with these distances and found that both complied with the time taken by the cyclist from B to A.

## CONCLUSIONS

The process of solution employed by this team of students is arithmetic, as they connected the problem, and afterwards finalized the operations to find the unknown distances. Given that they connected the problem, it was not necessary to establish equations. Their first supposition was apt in the sense that they elected the correct values for the times, but if they had not done this they would have continued assigning values to the times of travel (and through the management of the involved relationships) until confirming that, effectively, the distances obtained were those they were looking for.

The characteristics of their thought are of the arithmetical type in spite of the fact that in the first phase (reading of the problem) the solution process the group was able to recognize the quantities involved as well the relationship between them, in the second phase of the process (establishment of conjectures) they did not interpret this information in algebraic objects and continued manipulating numeric quantities; because of this they did not write equations. Also, they used scalar operations (or vertical in the sense of Vergnaud, 1991), which denotes a fault of conceptual development of the multiplicative relationships.

However, given that this team was able to recognize the structure of the problem and the relationships involved we can say that this team was closer to algebraic thought than those that attempted to solve the problem through the formulation of a system of equations without being clear how to relate the quantities involved in the problem, that is to say, without having recognized the structure of the problem.

## References

- Bazzini, L. (1999). From Natural Language to Symbolic Expression: Students' difficulties in the process of naming. In O. Zaslavsky (Ed.), *Proceeding of the 23rd Annual Conference of the International Group for the psychology of Mathematics Education* (Vol. 1, p. 263). Haifa, Israel: PME.
- Bednarz, N. & Janvier, B. (1994). The emergency and development of algebra in a problem solving context: a problem analysis. In J. da Ponte & J. Matos (Eds.), *Proceeding of the 18<sup>th</sup> Annual Conference of the International Group for the psychology of Mathematics Education* (Vol. 2, pp. 64-71). Lisbon, Portugal: PME
- Bednarz, N. & Janvier, B. (1996). Emergence and development of algebra as a problem solving tool: continuities and discontinuities with arithmetic. In N. Bednarz, C. Kieran & L. Lee (Eds.), *Approaches to algebra* (pp. 115-136). Holland: Kluwer, The Netherlands.
- Guzmán, J., Bednarz, N. & Hitt, F. (2003). A theoretical model of analysis of rate problems in algebra. In N. Pateman, B. Dougherty & J. Zilliox (Eds.), *Proceeding of the 27<sup>th</sup> Annual Conference of the International Group for the psychology of Mathematics Education* (Vol. 3, pp. 9-15). Hawai'i, USA: PME.
- Malara, N. (1999). An aspect of a long term research on algebra: the solution of verbal problems. In O. Zaslavsky (Ed.), *Proceeding of the 23rd Annual Conference of the International Group for the psychology of Mathematics Education* (Vol. 3, pp. 257-264). Haifa, Israel: PME.
- Vergnaud, G. (1991). *El niño, las matemáticas y la realidad. Problemas de enseñanza de las matemáticas en la escuela primaria*. Mexico: Trillas.



# INTRODUCING ALGEBRAIC THINKING TO 13 YEAR-OLD STUDENTS: THE CASE OF THE INEQUALITY

Petros Verikios and Vassiliki Farmaki,

Department of Mathematics, University of Athens

*As a part of a wider research project on the teaching and learning of basic concepts of school algebra by 13 year-old students via a functional approach, we present and analyse here some material on understanding and handling the inequality concept. Our focus is on difficulties that came up in going from equality to inequality. The data are parts from individual interviews given by five students after they had been taught a related course and while they were working in a situation problem admitting a solution by a linear inequality.*

## INTRODUCTION

In most countries (Greece included) inequalities are taught in secondary school as a subordinate subject (in relationship with equations), dealt with in a purely algorithmic manner. This approach implies a ‘trivialisation’ of the subject, resulting in a sequence of routine procedures, which cannot easily be understood, interpreted and controlled by students. As a consequence of this approach, students are unable to manage inequalities that do not fit the schemas taught (Boero and Bazzini, p. 140, 2004). According to Sackur (2004, p 151) an important and indeed crucial question is the apparent similarity among finding the solutions of equations and of inequalities. The emphasis is on formal algebraic methods, graphic heuristics, in general, are not exploited, and algebraic transformations are performed without care for the constraints derived from the fact that the inequality sign  $>$  does not behave like the equality sign  $=$  (Tsamir et al., 1999; Sockur, 2004, p. 148). Recent research on algebra learning, by focusing on students’ understanding of inequalities, has advanced our knowledge of students’ conceptions of inequalities in several ways. In particular, it has pointed out both the positive role that graphical representations can play in helping students to conceptualize better the symbolic form of inequalities, and the pitfalls involved in attempting to apply to the solving of inequalities some of the transformational techniques employed with equations (Kieran, 2004, p 144).

## A CONDENSED THEORETICAL FRAMEWORK

The learning of algebra in general is seen from four different perspectives (Bednarz, Kieran, Lee, 1996); the generalization perspective, the problem-solving perspective, the modeling perspective (mutual interchange ability between graphs, tables, symbolic expressions and verbal descriptions), and the functional perspective (variables and functions). Mathematics educators recommend that students use various representations from the very beginning of algebra learning, because, the use of verbal, numerical, graphical, and algebraic representations has the potential of

making the process of learning algebra meaningful and effective. The functional approach to algebra (see for example: Kieran, 1996; Yerushalmy, 2000) assumes the function to be a central concept around which school algebra can be meaningfully organized. This implies that representations of relationships can be expressed in modes suitable for functions and that the letter-symbolic expressions are such modes. Thus, algebraic thinking can be defined as the use of any of a variety of representations in order to handle quantitative situations in a relational manner.

## THE RESEARCH DESIGN AND THE DATA COLLECTION

Based on the general theoretical framework outlined above, we adopted an approach to school algebra learning that emphasises the modeling and the functional approach. We planned an introductory algebra course, which we applied to grade 8 students in a real conditions class in a public school of Athens. While adopting and accepting in general this *approach* to school algebra learning, at the same time we emphasise a teaching in *context* and with *comprehension* that uses function representations as mathematical tools, which can describe phenomena of the real world, in the context of beginning algebra. Problems which traditionally could be answered only by the formal solution of an equation or inequality were now treated in a variety ways: by trial and error working on a values table, by a graphic representation or by the algebraic mode. Students were introduced to the concepts of equation and inequality through activities that promoted different representations of function, and students used them as problem solving strategies.

The data, for the main research, were selected in three different ways: from class observations, from works and tests given to students, and from interviews; we interviewed eight students individually, each interview consisting of five parts, covering essentially all the subjects taught in the course. In our present work (a) we restrict our attention to problems of understanding the inequality and its relation with equation, and more specifically to the research question: what are the problems and the difficulties that students face in the transition from equation to inequality and what are the implications of the apparent similarity between the solving of equations and the solving of inequalities? (Sackur, 2004, p. 151); and, (b) we approach this question by presenting and analysing samples from five students' interviews, which contained a situation problem, a break-even task, which was modeled by an equation  $ax+b=c$  and the corresponding inequality  $ax+b<c$ . It should be noted that, in our course, less time was devoted for the inequality than for the equation, and that the students had not constructed a complete cognitive scheme for this concept. So, we can reasonably assume that, during the interviews, the students were still trying to develop and evolve an adequate cognitive scheme for the inequality concept.

## THE BREAK-EVEN TASK: TAXI PROBLEM

When we use a taxi we pay a 'standard charge' 0.80€ and in addition 0.30€ per kilometer.

1. If we pay  $y$ € for a route of  $x$  kilometers, express  $y$  as a function of  $x$ .
2. Describe how you can construct the graph of this function.

3. Two friends, George and Tom, are in the center of Athens, in Omonia square. George takes a taxi for his house. He pays for this route 3.5€. How many kilometers is his house from Omonia square?
4. Tom takes also a taxi for his house. For this route, he gives the taxi driver 5€ and takes change. How many kilometres can be his house from Omonia square?

Here we are interested in question 4. The students, working in the previous questions of the problem, already had constructed the model of the situation by the function  $y=0.3x+0.8$  (question 1), or by its graph (question 2), and had answered question 3, using a values table or a graph or solving an equation (e.g.  $0.3x+0.8=3.5$ ).

## SAMPLES OF STUDENTS' ANSWERS

### The transition from equation to inequality and the solving strategies

All the students realised that there is an important difference between question 3, and question 4. The word *change* is decisive because it constitutes a *bridge* from equation to inequality, as it appears in students' answers. For example; Olivia: *we will proceed as before...  $5=x0.3+0.8$  based on formula  $y=x0.3+0.8$  with  $y=5€$ ... ok, he did not pay precisely 5€, almost 5€, Helen: ... he takes changes ...  $5-y$  ... they are a lot of solutions, and Sotiris: *the cost  $y$  is not given to us ... we do not know anything... we know that he gave 5€... we do not know the final cost... it is hard... it is not as before, because it does not give us, e.g. 3.5€ ... the cost precisely...I don't know.**

The situation context helped students to realize the difference between situations that from the expert's perspective, involve the concepts equation or inequality, respectively; as a result the students realised the first step from equation to inequality.

The students were encouraged to use any mode in order to solve the problem. When a student gave an answer to the question, the interviewer encouraged him to think of an alternative method. Only one student adopted from the beginning the algebraic way of solving, while all the others used the already constructed graph of the function  $y=0.3x+0.8$ ; of them, two students used the values table. So the strategies used were: the values table, the graph, and the algebraic mode.

### Approaching the inequality concept

Andrea, a performer above average, answered the question constructing and solving the inequality  $y<5$  or  $x\cdot 0.30+0.80<5$  without difficulty. She was then encouraged by the interviewer to provide an answer using the graph. There she faced an obstacle how to interpret  $y<5$ , as it appears in the following extract.

Andrea: if we go up to some value less than 5 ... and continue in straight line with all the values until... [She brings a 'mental' line with her pencil] ... 12 appears [in x-axis].

Interviewer: can we also get to 12.5?

Andrea: yes, if we continue ... how to find it with *precision*?

Interviewer: up to what can we continue?

Andrea: up to 4.5 [she shows in the y-axis]

Interviewer: can we up to 4.9?

Andrea: yes, and up to 4.9.

Interviewer: can we go to 5?

Andrea: no, because he took some change.

Then, based on her ‘algebraic’ answer, she observed that  $x=14$  results for  $y=5$ , and she drew the suitable lines (figure 1), determining 14 on the x-axis and saying: ‘*from the value 5 ... hence under 14*’. When the researcher asked from her to show on the x-axis the solutions, she pointed out the numbers from 1 up to a little before 14 on the x-axis. So, with this defect she means that 14 is not included in the solutions. It will now be observed that she is gradually succeeding in building and developing a cognitive scheme for inequality; and that intuitively she approaches the concept of limit, trying to interpret the genuine inequality  $0 < x < 14$ , via the graphic representation.

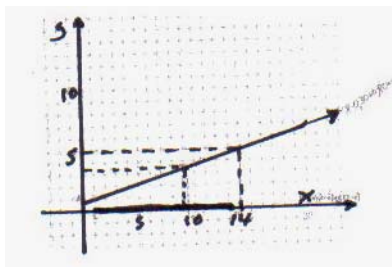

figure 1 (from Andrea’s work)

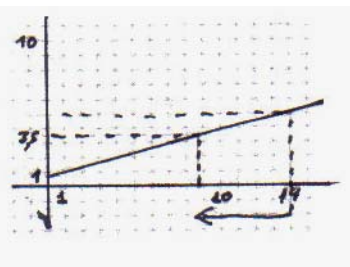

figure 2 (from Sotiris’s work)

On the other hand Helen, an average performer, answered the question using the graph without difficulty. When she was encouraged by the interviewer to answer with an alternative way, she developed an interesting approach to inequality, based on the notion of equation, namely via a collection of equations, whose solutions as a totality is equivalent to the inequality solution. Specifically she reported: *...we find it with examples... or with the formula [she shows  $y=0.3x+0.8$ ]... 5€ gives 14 kilometres [it had been found graphically]...  $0.3x+0.8$ ... 14 kilometres ... we can do the same also with 4€ and 3€ and ... **equation**... there are a lot of solutions*. She comprehends that the taxi fare is a number less than 5 and in order to find each route corresponding to such a fare she should solve the corresponding equation. Thus in order to find the routes for 4€ or 3€, she has to solve the equations  $x \cdot 0.30 + 0.80 = 4$  and  $x \cdot 0.30 + 0.80 = 3$ , respectively, and in general for each fare less than 5, in order to find the route, the same procedure is to be used. According to Helen’s thought all the solutions of these equations are possible answers to the question and hence possible answers to the inequality  $x \cdot 0.30 + 0.80 < 5$ . So the inequality represents the collection of all these equations. This idea, closely related to her initial conclusion that ‘*there are a lot of solutions*’, is an interesting action of understanding inequality, in that it locates a basic difference between inequality and equation, and so creates a ‘bridge’ between the two concepts, extending the equation concept.

The values table mode substantially constitutes a numerical, informal method, with trials for various values of  $x$  until  $y=5$  comes out, as developed for example from Helen when saying: ‘*5 minus  $y$ , I want to see how many possibilities are there for the change he has taken ... there are a lot of solutions ... I will find them with a value*

table... *I will consider examples*'. Then she went on to complete the values table with various values, until 6 € and concluded: *'as it appears from the value table, when he pays 5 euros he does 14 kilometres... well, we knew it before... however he takes back some change that is to say he pays less than 5... then he will do less than 14 kilometres ... as we see for example for 4.7 euros we do 13 km, more than 5 euros more than 14 kilometres'*. We believe that the values table strategy constitutes a good and understandable first approach to the inequality, before its formal teaching. Sotiris, the student with the lowest performance, had various difficulties to arrive at a correct answer either graphically or algebraically. Surprisingly it was precisely the *change* itself that presented an obstacle for him. He kept considering that we do not have any clue on how to handle the situation, because the fare paid is less than 5 euros and does not constitute precise information. After an extensive dialogue and in order to overcome this impasse, the interviewer focused on the graph, in relation to question 3, saying: *'if I tell you that he paid less than 3.5 euros what could you say ... how many kilometers did he do?'* and only then Sotiris realised the situation and concluded *'less than 9 ... aaa ... so, I'll go to 5 and ... [figure 2] ... how much is it? 14... less than 14'*. The discourse with the interviewer proved fertile and helped him to overcome the obstacle and to achieve a satisfactory level of comprehension: by building on his previous knowledge, he could find and *show* on the x-axis the values of x.

### **Problems that students met in the inequality construction¶**

The first step of the algebraic solution is the construction of the inequality. Two students constructed it easily, but for the others it was not that easy. For example, Sia, an average performer, reported: *'y equals ... ok y is equal less ... can I say y equals less than 5 and to continue... because euros are less than 5...  $y < 5$ '*. Sia could not make the transition from the inequality  $y < 5$  to the equivalent inequality  $0.80 + 0.30x < 5$  and thereby find the x values. Similarly, Sotiris had difficulties in constructing the inequality. Via a long, but productive, dialogue with the interviewer, he finally realised that *'the amounts aren't equal ... 5 is of course more than the taxi fare ... they are unequal'*. When the interviewer suggested that he write down a relation showing it, he replied: *'as an inequality ... [and he writes  $5 - y$ ] ... because he also was given change'*. His intuition was that what was wanted was not an equality relation; although he reported the word *inequality*, he nevertheless could not bring himself to formulate the inequality  $5 > y$  or the equivalent  $5 > 0.3x + 0.8$ . Student' symbolizations are interesting, however the transition to inequality was a problem for them and they were able to represent correctly only a part of the situation. It is possible that the formula  $y = 0.80 + 0.30x$  constituted an obstacle for them, because they could not identify the representation of the amount y with the expression  $0.80 + 0.30x$ . The help of the interviewer was essential in order that they construct the inequality. The difficulty of inequality construction was clearly formulated by Sia: *'the equation and the inequality ok I can solve them ... I can not easily construct them'*. Olivia, an average performer, faced a different kind of difficulty in the inequality construction. She had difficulty to discriminate equation from inequality, and thus to realise the transition from equation to inequality. She said: *'we will do*

that as before...  $5 = x \cdot 0.3 + 0.8$  based on the type  $y = x \cdot 0.3 + 0.8$  with  $y = 5€$  ... ok, he did not pay precisely 5€, **almost** 5€. The interviewer's question 'less or more?' helped her to understand the somewhat fine difference between the two situations making the transition, saying: 'less... that is we should **not** use equality... it should be  $5 > x \cdot 0.3 + 0.8$ '.

### Problems that students faced in solving of the inequality algebraically

The students solved algebraically the inequality using the same procedures as in the algebraic solution of the equation. Olivia and Sotiris reported clearly that: '*the solution of the inequality will be as in the equation*'. This powerful identification, in solving equation and inequality, gives the impression to the students that the only difference is on the sign. That misunderstanding leads to faults, because algebraic transformations are performed without taking into consideration the constraints deriving from the fact that the  $>$  sign does not behave like the '=' sign (Tsamir et al., 1998). For example, Sotiris, solving the inequality  $0.3 \cdot x + 0.8 < 5$ , wrote the equivalent  $0.3x < 4.2$  and continued dividing by 0.3 both sides. He did not appear sure about the inequality sign and lastly he concluded that: '*I have to change the symbol ... it always changes in the end*' and he wrote  $0.3x/0.3 > 4.2/0.3$ . Similarly, Helen solving the inequality  $5 > 0.8 + 0.3x$ , wrote the equivalent  $-0.3x > -4.2$ . She divided with  $-0.3$  both sides without changing the sign  $>$  and found as solution  $x > 14$ . Observing this answer with her answer from the graph strategy, she understood that something wasn't going right, so she changed the sign  $>$  with  $<$  and justified it: '*it changes because it is negative*'. Although her explanation seems adequate, in another interview, when she was solving the inequality  $-1x < -4$ , it appeared that she acted without deeper understanding: '*I divide with -1 and... the direction will change ... because it is negative ... ah here we have two negatives ... the direction will not change ... I don't remember... I believe that it changes because in the right side there is a negative*'. Also, when Olivia was solving the inequality  $5 > 0.3x + 0.8$ , and wrote the equivalent  $4.2 > 0.3x$  (figure 3) she divided with 0.3 writing  $x = 14$  (the erased equation, 2<sup>nd</sup> line in figure 3). The dialogue with the interviewer is characteristic:

Interviewer: *why the sign  $>$  changed and became  $=$ ?*

Olivia: [she changes her solution  $x = 14$  and write  $x \geq 14$ ]

Interviewer: *why did you put  $x$  it in the other side?*

Olivia: *ahh...yes* [she erases the previous  $x \geq 14$  and write  $14 \geq x$ ]

Interviewer: *why did you put the equal sign here? Can it enter...*

Olivia: ... *if he gave 5 euros he would do 14 ... he takes change ... no it can't* [and she erases the sign  $=$  and write  $14 > x$ ].

$$\frac{4.2}{0.3} > \frac{x \cdot 0.3}{0.3}$$
~~$$x = 14$$~~

$$14 > x$$

figure 3

She handled the unequal sign almost like the sign of the equation. This misunderstanding allows her to consider equivalent the inequalities  $14 > x$  and  $x > 14$ , as it happens for the equations  $x = 14$  and  $14 = x$ . The context of the problem helped him to check her solution and to correct the sign in  $14 \geq x$  writing  $14 > x$ .

### How to read the inequality $x < 14$ ?

Three students read the inequality  $x < 14$  as follows: '*x equal less than 14*'. One possible interpretation is that these students are still thinking in terms of equation and make a corresponding mental transfer to inequality considering that the solution is 14. Another possible interpretation is that '*equal*' is used with the meaning of '*is*', that is to say  $x$  *is* (a number) *less* than 14. In favor of the second interpretation is our observation that many students when they wish to represent by symbols the element requested in solving a problem, such as '*the number of the days*', write '*x=days*' instead of the formally correct expression '*x is the number of days*'. The interpretation intended requires further investigation.

### An obstacle in handling zero

Two students had a similar difficulty in regard to the number *zero*. Concretely, Helen solving the inequality  $5 > 0.3x + 0.8$ , wrote  $-5 + 5 > 0.3x + 0.8 - 5$ , then erased the opposite numbers  $-5 + 5$ , and continued writing  $-0.3x > 0.3x + 0.8 - 5 - 0.3x$ . To the interviewer's question: '*what is the meaning of this deletion on the left side?*' she responded: '*nothing ... let it be like that*'. She realised that *zero* here is the result of performing the operation of addition, only when the interviewer posed the question: '*didn't you perform an operation here on the left side?*' Helen did not write zero explicitly, and this shows that she had an obstacle in handling-accepting zero as a number; however, despite this obstacle, she had no problem in continuing with the solution, as is made apparent by her third inequality (above). Sotiris faced a similar obstacle in another interview when he tried to solve the equation  $2x = -x + 6$ . He muses on how to proceed: '*I must move the unknown term  $2x$  to the other side ... [he stops the process and then says with surprise] ... but then on the left side nothing will remain ... so I can not continue the process*'. An essential dialogue with the interviewer was needed so that Sotiris realise that '*... if we remove  $2x$  ... it means that ... what will remain will be zero*'. Contrary to Helen, Sotiris, after moving the sole term  $2x$  from the left side to the other side, was unable to continue the solving process, because he considered that on the left side nothing remains, and so the equation had been reduced to the form '*nothing=something*', and it was now an equation that did not have one side. As such situation did not conform to his concept image of equation, he decided, finding himself in an impasse, that *I can not continue the process*. In the behaviour of these two students we detect obstacles in handling of symbols, specifically '*students' weakness in handling or accepting zero as a number*'.

### SOME CONCLUDING REMARKS

The passage from the equation in the inequality is a rather sophisticated process. The situation context could help students to make this passage, as evidenced in the particular problem with the word *change*. The functional approach permitted the students to move towards the inequality via various function representations. The students showed an ease in interpreting the situation, and in coming near the concept of inequality, with the graph representation; however a difficulty emerged with the graph approach in that there was an unwillingness to examine the limiting role of the

number 5 in the inequality  $x \cdot 0.30 + 0.80 < 5$ . In the algebraic solution serious difficulties came into the surface, concerning the inequality construction, and the inequality solution process and its apparent similarity with the equation solution process. To a substantial percentage of the students of their age, the properties of relations and of operations needed for the algebraic solution constitute a non-trivial cognitive change. These difficulties were the cause for a number of obstacles such as (a) the division with negative number without changing the inequality sign or the routine change of the sign without understanding the reason for it; (b) the surprising notion that the inequality  $14 > x$  is equivalent to the inequality  $x > 14$ ; (c) the mistaken expectation that the inequality solution, in analogy to the equation solution, is given by a unique value, and the difficulty to realize the rather advanced for their age concept that the inequality solution is rather an interval of values; and (d) students' weakness on handling/acceptance zero as a number. Our findings suggest that presenting the formal solution demands a greater maturity on the part of the novice than we have a right to expect and could best be postponed for a later age (see also Yerushalmy, 2000). Till then it is preferable and helpful to employ approaches and strategies, such as graph, values table, less formal and more understandable than more formal and less understandable. The functional approach has additional advantages in that it enables the students to develop problem solving abilities such as the heuristics 'trial and error', 'draw a diagram', 'solve an equation or inequality', and also in that it fosters visual thinking, a particularly useful mathematical mode in the advent of new technologies.

## References

- Bednarz N., Kieran C., and Lee L. (eds), (1996). *Approaches to Algebra: Perspectives from Reserch and Teaching*, Dordrecht, Netherlands: Kluver Academic Press.
- Boero P., Bazzini L. (2004). Inequalities in Mathematical Education: The need for complementary perspectives, *Proc. of PME28*, Bergen, Norway, I, 137-139.
- Kieran C. (2004). The equation/inequality connection in constructing meaning for inequality situations, *Proc. of PME28*, Bergen, Norway, Vol. I, 143-147.
- Sackur, C. (2004). Problems related to the use of graphs in solving inequalities, *Proc. of PME28*, Bergen, Norway, I, 148-152.
- Tsamir P., Almog N., Tirosh D. (1998). 'Students' solutions of inequalities', *Proc. of PME 22*, Stellenbosch, South Africa, VI, 129-136.
- Yerushalmy M. (2000). Problem solving strategies: A longitudinal view on problem solving in a function based approach to algebra, *Educational Studies in Math.* 43, 125–147.



# WHY IS A DISCONTINUOUS FUNCTION DIFFERENTIABLE?

Antti Viholainen

Department of Mathematics and Statistics  
University of Jyväskylä, Finland

*In formal mathematical knowledge definitions have a decisive role in characterising concepts. However, in creative mathematical thinking many kind of informal interpretations and representations are needed. First we briefly review the features of mathematical knowledge and mathematical thinking from this point of view. Then we analyse the reasoning processes of two subject teacher students in mathematics and discuss why their reasoning considering differentiability led to wrong conclusions. An essential reason for this seemed to be that they used methods which were not compatible with the formal theory.*

## INTRODUCTION

The starting point of the study presented in this paper was a result of a question in a written exam, which was participated by 146 subject teacher students in mathematics from six universities in Finland and 20 subject teacher students from one university in Sweden. More than one fourth of the students answered that a function (function  $h$  in Figure 1) is not continuous but differentiable despite that all of them had met in their studies an essential theorem of calculus which says that continuity is a necessary condition for differentiability. So these results were very surprising and highlighted the question why so many students had made this kind of conclusion and, more general, how do the students make conclusions and why some conclusions are wrong. This report is based on an analysis of the interviews of two participants of the exam and the main goal is to present some views to the questions mentioned above.

## THE NATURE OF MATHEMATICAL KNOWLEDGE AND MATHEMATICAL THINKING

According to the formalistic point of view, mathematical concepts are separated from their perceptual meanings and fully determined by their formal definitions. The relationships between the concepts are fully determined by axioms and pure deduction and so the proofs of them are fully independent of perceptions. However, from the cognitive point of view, different interpretations are very essential factors in mathematical thinking. Usually these interpretations help to concretise the formal definitions and the formal claims and they also have a very significant role in inventing ideas in problem solving situations. Visualization is probably the most usual way to concretise mathematics. Both in learning and in problem solving situations visualization supports and illustrates formal claims and results, resolves possible conflicts between formal solutions and intuitions and helps in re-engaging

and recovering conceptual underpinnings which may be easily bypassed by formal solutions (Arcavi 2003, 223-224).

Mathematical thinking is based on different kinds of *internal representations* of mathematical concepts. Internal representations are mental configurations of individuals (Goldin & Kaput 1996, 399). Visual representations are very important in mathematical thinking but representations can, in addition, be for example verbal, notational, strategic or affective (Goldin 1998). In order for all representations to create a consistent and viable aggregate, it is important that the representations have good connections with each other. According to terminology of Tall and Vinner (1981) a *concept image* of a concept is an entity, which consists of all cognitive structures associated with the concept. So we can think that the concept image includes all the representations of the concept and all pieces of knowledge concerning the concept. Mathematical thinking and reasoning are based on several portions of the concept image and if these portions are not consistent with each other, contradictory conclusions are possible (ibid. 153).

As stated above, due to the formal deductive nature of mathematics, the roles of definitions are definitely essential in mathematical knowledge. In order to use formal definitions in creative thinking they have to be understood, which means that the personal interpretation of the formal definition includes essentially the same information as is intended by the definition. These interpretations can be based on different kinds of representations and they itself are also representations of the concept. Although we can say that the most reliable way to do conclusions concerning mathematical concepts is to base reasoning on definitions (and, if needed, axioms and theorems) this cannot be the only solution to the problem of wrong conclusions, because in the creative and effective mathematical reasoning it is very useful –and often in practice necessary– to utilize many kinds of informal representations. One possibility would be to strengthen connections between the formal definition and representations of the concept. Hähkiöniemi (submitted) has defined that “a person makes *reflective connection* between two representations if he or she uses one representation to explain another”. By using this notion we can say that in an ideal concept image of a concept, the personal interpretation of the formal definition corresponds to the definition and in every situation it is possible to make a reflective connection between the personal interpretation of the definition and representations which are used in that situation. This means that a person is able to explain on the basis of the definition how and why the use of these representations is justified. In that case the reasoning would be based on deeper and more conceptual understanding and the reasoning process itself would deepen the understanding.

## METHODOLOGY

The main research questions of the larger research (see the Introduction chapter) were: how well do subject teacher students in mathematics, in the final phase of their studies, understand the informal and the formal sides of mathematics in the case of derivative and differentiability and how can they use these sides in problem solving.

The data includes answers to a written exam from all 166 participants and 28 personal interviews of the participants of the exam.

$$f(x) = \begin{cases} x + 1, & x < 1, \\ -2x + 6, & x \geq 1. \end{cases} \quad h(x) = \begin{cases} x^2 - 4x + 3, & x \neq 4, \\ 1, & x = 4. \end{cases}$$

$$g(x) = \begin{cases} x + 2, & x < 1, \\ -2x + 5, & x \geq 1. \end{cases} \quad i(x) = \begin{cases} x, & x < 1, \\ x + 1, & x \geq 1. \end{cases}$$

Figure 1: The expressions of the functions used in the interviews.

In the interviews the students were given functions presented in Figure 1 and they were asked to explain why each of the functions were differentiable or why they were not. In some cases continuity was also considered. An essential research question was: how are the interviewees' arguments connected with the definitions? The functions were given to the interviewees by showing the expressions and the graphs in paper. The functions  $f$ ,  $g$  and  $h$  were used also in the written exam. The interviews included also discussion about visual meaning of derivative and differentiability and the relationships between continuity and differentiability.

The interviews were semistructured: only the main questions were planned in advance. It was not possible (it was not appropriate) to consider all question with all interviewees and on the other hand many additional questions emerged during the interviews. Also the order of the questions varied with the interviewees. The formal definitions of continuity, derivative and differentiability were given to the participants both in the written exam and in the interviews. In the interviews the only allowed tools were pen and paper. The interviews were videotaped so that the video camera was focused on the paper.

The selection of the interviewees among the participants of the written exam was done on the basis of a quick analysis of the written exam. The goal was to collect data to case studies and so, keeping in mind the research questions, authors of the most interesting answers to the exam questions were selected. Another criterion for the selection was the goal to get different kinds of students as regards their performance in the exam. The willingness of the students to participate was also taken into account. The group of interviewees are not claimed to represent the whole group of the participants of the exam.

Eight persons, who had in the written exam answered that the function  $h$  in Figure 1 is differentiable but discontinuous, were interviewed. Two most interesting of these interviews were selected a deeper analysis. These seemed to offer good data for students' concluding processes and reasons for wrong conclusions. The deeper analysis applied video data analysis procedures presented by Powell et al. (2003). The interviews were first transcribed from the video. Then the transcribed data was divided to episodes so that every episode included reasoning concerning one question. Then the progress of students' reasoning in the episodes was described and critical events were identified. By comparing episodes and *critical events* of one

interview and by searching common features of them, it was possible to find some features of students' thinking which were typical in the interview as a whole. Finally it was also possible to find some fundamental reasons to wrong conclusions.

## ANALYSIS OF THE INTERVIEWS

Both interviewees, Mark and Theresa, were majoring in mathematics. Mark had studied five years and Theresa four years in university. According to Mark, his success in his studies had been of average level, and Theresa evaluated that hers had been good. Theresa told that she would like to teach mathematics at the upper secondary level, whereas Mark wanted to teach only at the lower secondary school.

### Mark

In the questions concerning differentiability Mark seemed to have as a method to differentiate both expressions used in the definition of the function by using differentiation rules and then to check if both the expressions obtained an equal value at the point where the expression is changed. In the case of the function  $g$ , Mark offered first a visual argument that it was not possible to draw an unambiguous tangent line to the corner. When the interviewer asked Mark to calculate the right-hand and left-hand limits for the difference quotient of the function  $g$  at the point  $x=1$ , Mark differentiated the expressions  $x+2$  and  $-2x+5$  and gave answers 1 and -2. He said: "The use of difference quotient would lead to the same result." When asked, he was without any problems able to do this, but his primary method to use differentiation rules shows that he did not see any need to do it. In the case of the function  $f$  he used also the same differentiation method: his argument on differentiability of the function  $f$  was that the derivatives of the expressions  $x+1$  and  $-2x+6$  were not equal at the point  $x=1$ . When asked why he had answered in the written exam that the function  $h$  was differentiable, he explained, after a short thinking, that the derivative existed everywhere:

Mark: At point four the derivative is zero.

Interviewer: Why?

Mark: Because it is a constant!

He did not explain if there was something wrong in this explanation, but in the interview Mark yet wanted to use the same kind of method as in the cases of functions  $g$  and  $f$ . So he differentiated the expressions  $x^2-4x+3$  and 1 and got expressions  $2x-4$  and 0. Because these did not take equal values at the point  $x=4$ , Mark concluded that the function  $h$  was not differentiable. Again Mark trusted his method and did not see any need to consult the definition.

The question about differentiability of the function  $i$  was a big problem for Mark. He started like earlier by calculating the derivatives of the expressions  $x$  and  $x+1$  and noticed that these were equal at the point  $x=1$ . When calculating these he spoke about the difference quotients: "The difference quotients are equal in both domains." According to Mark this should mean that the function  $i$  were differentiable. However, Mark immediately saw from the graph that the function  $i$  was not continuous and he

remembered very clearly that the continuity is a necessary condition for differentiability. This caused a serious conflict for Mark but his confidence to his method was strong:

Mark: Yes, the both derivatives are equals, if we come either from left or from right... [...] If we think only that they are equal... then it has to be differentiable... but it is not continuous at that point!

Then Mark began to doubt his memory. He tried to find another function being differentiable but discontinuous. He wondered if the tangent-function was one example. Finally he decided to explore the differentiability of the function  $i$  by using the definition of derivative. However, he made a mistake in this: he calculated the limits of the difference quotient for the expressions  $x$  and  $x+1$  separately and got equal results. After that he finally concluded that his memory had to be wrong and the function  $i$  was differentiable:

Mark: One comes from the both. It could be reasoned from this, that it is differentiable.

Interviewer: Is it your answer?

Mark: Ok, let it be my answer at this time!

### Theresa

The interview with Theresa began with a discussion about the relationship between continuity and differentiability. Theresa remembered that there existed a theorem concerning this relationship but she was not sure what it said. The first thing which she mentioned about this relationship was that, the differentiability did not presume continuity: “At least, a discontinuous function may be differentiable.” She argued this by drawing a graph of a function like  $h$  in Figure 1. (She drew a parabola which jumps at one point.) She seemed to be very convinced that this function was differentiable at every point, also at the point where there was a jump in the graph.

Interviewer: You think that this is discontinuous but differentiable?

Theresa: Yes, because it is possible to draw a tangent!

To the point where the jump happened, she even drew a “tangent”; she drew it to the parabola as if there was not a jump.

Theresa continued to think about the relationship between continuity and differentiability. Next she noticed that continuity did not presume differentiability. She drew a graph having a corner (like the graph of the function  $g$  in Figure 1) and explained that to the corner it was not possible to draw an unambiguous tangent (she drew several possible “tangents” to the corner) and so the function was not differentiable even if it was continuous.

These two examples led Theresa to a conflict: she remembered that there existed some theorem concerning continuity and differentiability but her examples seemed to show that it was not possible that all continuous functions were differentiable or vice versa. She double-checked her reasoning and finally she concluded that her memory had to be wrong. This suggests that she had a strong confidence in her reasoning and also in her interpretation for differentiability as a possibility to draw a tangent.

Theresa gave two arguments why the function  $f$  was not differentiable. At first she explained that the derivatives of the expressions  $x+1$  and  $-2x+6$  did not take equal values when  $x=1$ . Then she also explained that it was not possible to draw a tangent to the graph at the point  $x=1$ . She reasoned this by drawing several lines (possible tangents) through the endpoint of the left-hand half-line. In the case of the function  $i$  she noticed that the derivatives of the expressions were equal at the point  $x=1$ , but despite of that, it was not possible to draw a tangent to the graph in this point. Theresa was sure that the function  $i$  was not differentiable:

Theresa: This is not differentiable despite of that these both (differentiated expressions) take 1.

Interviewer: Why is it not differentiable?

Theresa: No, I think about the tangent, it is not possible to draw an unambiguous tangent at the point  $x=1$ .

The method based on tangent seemed very clearly to supersede the algebraic argument. Theresa was also asked to argue this by using the definition of derivative. Theresa was very insecure of her ability to use the definition:

Theresa: Oh, I believe I won't be able to write it, wait a moment... I don't remember... [...] I cannot use that, I did not understand that at high school...

After a few minor problems, Theresa finally managed to calculate the left-hand and right-hand limits for the difference quotient at the point  $x=1$ .

## CONCLUSIONS

A typical feature of Mark's thinking in the interview was a kind of algorithmic thinking. His method in questions considering continuity and differentiability of functions presented in Figure 1 was to find an algorithm which works well. In the cases of the functions  $f$ ,  $g$  and  $h$  the differentiating algorithm seemed to be easy to apply and it did not cause conflicts. It is understandable that this increased Mark's confidence on his method. It is not yet very clear why Mark had from the beginning so strong confidence on his method. Before the questions analysed above, the interviewer asked questions concerning continuity of the same functions. Mark used also then a same kind of method: he checked that the two expressions, given in the definition of a function, got an equal value at the point where the expression is changed. It may be that the use of this method impacted to the implementation of the differentiation method used in exploring differentiability.

As seen above, Mark clearly had several pieces of knowledge about derivative and differentiability in his mind, especially concerning calculus, but he had weaknesses in connections between them. So we can say that his concept images of these concepts were incoherent. An obvious indication of this is the invention and implementation of the differentiation method. This method lay on an unsure basis. Mark did not even try to find any justification to it. It was only a separate piece of knowledge in his mind. Because Mark in the cases of the functions  $g$  and  $i$  spoke about the difference quotient when differentiating the expressions, it is obvious that Mark remembered

that the use of differentiating rules is an easy way to calculate limits of the difference quotient. However, he was not able to utilize this fact in a right way in these situations and, in addition to that, in the case of function  $i$  he was not able to use the expression of the difference quotient in a right way. These features in his reasoning suggest also to the incoherence of the concept image.

Theresa's interpretation for the differentiability as a possibility to draw a tangent to the graph had a very determining role in her concept image of this concept. Thus, the decisive method for her to find out if a function was differentiable was based on this interpretation. She used this method in all four cases in the interview. In the cases of the functions  $f$  and  $i$  she used also an algebraic method and in the case of the function  $i$  these two methods led to contradictory conclusion but very clearly the tangent-method was decisive. So we can say that the interpretation for the differentiability as a possibility to draw a tangent took the role of the definition in her concept image. This interpretation could have worked very well if she had had an exact enough conception about the tangent. In the case of the function (like)  $h$  she thought she drew a tangent –in figure it looked very well like a tangent– but it was not a tangent. Due to the strong confidence on this interpretation she did not see in her reasoning any need for the use of the definition and, in addition to that, she felt the use of the definition was difficult for her. Also Theresa did not present any justifications for her method.

Both Mark and Theresa used several representations for the derivative and differentiability and their reasoning was essentially logical. Common to both of them was also that in the questions concerning differentiability they used methods which were not based on the definitions and were not compatible with it. Mark used an algebraic method and Theresa a visual one. Both trusted very strongly to their methods and so they did not see need to use the definition. Their methods seemed to work very well but in some cases led them to wrong conclusions.

According to some previous studies, students at any level feel that it is difficult to consult definitions and very often they do not do that (Vinner 1991; Pinto 1998, 294). This is confirmed also by this research. In addition to that the interviews give the impression that for the students their own methods were the decisive arguments in their problem solving and the definition offered to them only one –very intractable– argument. This suggests that probably they had not completely internalized the role of definitions in mathematical knowledge. At least it can be said that the definition was not in the position of the ruler in their concept image, rather it was an alone portion which had hardly any connections to the other portions.

## References

- Arcavi, A. (2003). The role of visual representations in the learning of mathematics, *Educational Studies in Mathematics*, 52(3), 215-241.
- Goldin, G. A. (1998). Representational systems, learning and problem solving in mathematics, *Journal of Mathematical Behavior*, 17(2), 137-165.

- Goldin, G. A., & Kaput, J. J. (1996). A joint perspective on the idea of representation in learning and doing mathematics. In L. Steffe, & P. Nesher (eds.), *Theories of Mathematical Learning*, (pp. 397-430). Mahwah, New Jersey: Lawrence Erlbaum.
- Hähkiöniemi, M. (Submitted). Associative and reflective connections between the limit of the difference quotient and limiting process. Submitted to *Journal of Mathematical Behavior*.
- Pinto, M. (1998). *Students' Understanding of Real Analysis*, PhD Thesis (unpublished), University of Warwick, UK.
- Powell, A. B., Francisco, J. M., & Maher, C. A. (2003). An analytical model for studying the development of learners' mathematical ideas and reasoning using videotape data, *Journal of Mathematical Behaviour*, 22, 405-435.
- Tall, D. & Vinner, S. (1981). Concept image and concept definition in mathematics with particular reference to limits and continuity, *Educational Studies in Mathematics*, 12, 151-169.
- Vinner, S. (1991). The role of definitions in teaching and learning. In D. Tall (ed.), *Advanced Mathematical Thinking*, (pp. 65-81). Dordrecht, The Netherlands: Kluwer.



# OVERGENERALIZATION OF LINEAR MODELS: PRESENCE AND CHARACTERISTICS AMONG UNIVERSITY STUDENTS<sup>I</sup>

Mónica Villarreal<sup>I</sup>, Cristina Esteley<sup>II</sup>, Humberto Alagia<sup>III</sup>

I. Faculty of Agronomy (University of Córdoba), II. University of Villa María,  
III. Faculty of Mathematics (University of Córdoba) - Argentina

*This research report presents a study of the work of preservice mathematics teachers in which an extension of linear models to non-linear contexts was observed. By linear models we mean the model  $y=a.x+b$ , some particular representations of direct proportionality and the scheme for the rule of three. The presence and persistence of this phenomenon among these students have been analyzed as a tacit model. We employ a qualitative methodology using students' mathematical written tasks and individual interviews. The results allowed us to notice the robustness of the linear models as a privileged mean for solving problems with a structure of three given data and a fourth unknown.*

## THEORETICAL AND EMPIRICAL BACKGROUND

The present report deals with problem solving approaches followed by preservice secondary school mathematics teachers from the University of Córdoba (Argentina). It extends previous research (Esteley, Villarreal and Alagia, 2004) related to a phenomenon which we denominate *extension of linear models to non-linear contexts* or *overgeneralization of linear models*. By linear models we mean the model  $y=a.x+b$ , some particular representations of direct proportionality and the scheme for the rule of three. Such a phenomenon could stem from the presence of a tacit model in the sense of Fischbein (1989). According to this author, “*Many of the difficulties students are facing in science and mathematics education are due to the influence of tacit intuitive models acting uncontrolled in the reasoning process*” (p. 9). We observed, in our previous studies, that when a problem showed a relationship between two variables with a structure of “three given data and a fourth unknown”, the students appeal to the rule of three tacitly assuming the existence of a direct proportional relationship between the variables. In this way, the use of the rule of three in problems with the structure previously described acts as a tacit model in the sense that the students are not aware of its influence and domain of applicability. As a tacit model it presents characteristics that make it robust, due to its practical nature, simplicity, and economy of action in terms of the possibility for solving such kind of problems.

The phenomenon of overgeneralization of linear models is also known as *linear misconception*, *illusion of proportionality* or *linearity* and *proportionality trap* (Behr, Hare, Post & Lesh, 1992). The tendency of overgeneralising the use of linear models beyond its range of validity has been extensively documented by the studies of Van Doorem, De Bock, Janssens & Verschaffel (2005); Van Doorem, De Bock, Hessels,

2006. In Novotná, J., Moraová, H., Krátká, M. & Stehlíková, N. (Eds.). *Proceedings 30<sup>th</sup> Conference of the International Group for the Psychology of Mathematics Education*, Vol. 5, pp. 337-344. Prague: PME. 5 - 337

Janssens & Verschaffel (2004a, 2004b); De Bock, Van Doorem, Janssens & Verschaffel (2002), De Bock, Van Doorem, Verschaffel & Janssens (2001) and De Bock, Verschaffel & Janssens (1998) with primary and secondary school students. These authors performed research based on written tests and some in-depth interviews mainly working with arithmetical, geometrical or probabilistic problems. They also reported the presence of the illusion of linearity in some historical examples, developed didactical materials and carried out some teaching experiments with the aim of overcoming the overreliance on linear models. The authors noted that, in spite of the use of those didactical materials, during teaching experiments, some students continued falling in the proportionality trap.

The presence and persistence of the phenomenon have been frequently and informally observed at the university level within diverse types of problems and contexts. In Villarreal, Esteley & Alagia (2005) we analyzed, in 18-20 year old agronomy majors' written productions, the types of problems that were solved by extension of a linear model, the strategies followed by the students and the difficulties of interpretation that could be associated with the statements of some problems. We also noticed that the teaching environment in which those students were involved followed a classical pattern: theory-examples-exercises. This type of teaching environment would not help the students to become aware of the existence of linear and non-linear worlds and could be contributing to the manifestation of the phenomenon of overgeneralization of linear models. In Esteley et al (2004) we presented an in-depth study through semi-structured interviews with the aim of getting understanding of the students' thinking processes when they extend linear models to non-linear contexts. In this case, we observed that, although the students used linear approaches to solve non-linear problems, their heuristics were adequate and introduced constraints, not present in the statements of the problems, but, in this case, were biologically reasonable. At this point, the students' errors were assumed to be symptoms of the conceptions underlying their mathematical activities, in the sense of Ginsburg (1977) or Brousseau (in Balacheff, 1984).

In sum, students from primary and secondary level as well as agronomy major students manifest the tendency to overgeneralise the linear models to non-linear contexts. In order to extend this study to other university contexts we decided to research the presence and characteristics of the phenomenon among preservice mathematics teachers.

## **RESEARCH METHODOLOGY**

The research methodology was qualitative (Lincoln & Guba, 1985) since we aimed to get in-depth understanding of the preservice mathematics teachers' thinking processes when they extend linear models to non-linear contexts.

Our methodological procedures were: 1) Selection of three non- proportional word problems, with a missing-value structure (see Figure 1). Problems A and C represent dynamical phenomena, while Problem B represents a static situation. Problem B was taken from De Bock, et al (2001).

**Problem A)** *If a plant measures, at the beginning of an experiment, 30 cm and every month its height increases 50% of the height of the previous month, a) how much will it measure after 3 months?, b) how much will it measure after  $t$  months?*

**Problem B)** *In a perfume store, bottles of a perfume A are sold. The bottles have a height of 8 cm and they contain 10 cl of perfume. In the store window it is published a bottle with the same shape but enlarged and containing the same perfume. This bottle has a height of 24 cm, how much perfume will this large bottle contain?*

**Problem C)** *A farmer fills a silo with grains in such a way that the quantity of grains entering each day doubled the quantity entered the day before. If after ten days the silo is full, in which day did the farmer join the quantity of grains necessary for filling half of the silo?*

Figure 1: The Problems

2) Ask eighteen (the whole class) 20-22-year old preservice mathematics teachers from the University of Córdoba to write the solutions of the problems during one of their regular classes. The students were attending a linear algebra course corresponding to their third semester. We decided to work with these students because the teacher was a member of our research team. 3) Analyse the written solutions and registered the presence of the phenomenon and the students' strategies. 4) Select students that had shown in their written solutions the appearance of the phenomenon of interest or some unexpected non-linear strategies and prepare individual semi-structured interviews according to their written work. 5) Carry out a single an-hour-long interview with each student. The interviewer was not the students' teacher. All interviews were audio-taped and the interviewees were provided with paper, pencil, and a scientific calculator just in case they needed them.

In this paper we report results related to Problem B, mainly coming from the interviews. The interviews were structured around the activities and aims we describe next. Activity 1) Ask the student to explain the way she/he had solved the Problem B (see Figure 1) in her/his written solution with the aim of elicit the student's strategies and reasons to apply a linear model in a non-linear context. Activity 2) Provoke a conflict by confronting the students' answers coming from a linear approach with a fictitious frequency table showing the answers of another group of students. The confrontation was done by telling the student that, in another mathematics course, the same problem was given and that the frequency table exhibited that 43% of the class answered that the large bottle would contain 270 cl of perfume (it represents the expected answer working under a similarity hypothesis), another 43% answered 30 cl (it represents an expected linear solution), and 14% gave other answers. Then, the interviewee was asked to imagine/explain what the students that answered 270 cl were thinking on in order to give that answer. The aim, in this case, was to provoke a first conflict with her/his proportional solution. Activity 3) If the student didn't change her/his mind, we would show a non-proportional correct solution from a fictitious student (see Figure 2) with the aim of deepen the conflict and challenge the

student's inadequate solution. These last two activities correspond to the phases 2 and 3 described in De Bock, et al (2001)'s methodological procedures.

*If the bottle is three times higher and it keeps the same shape, not only its height, but also its width and its length, are multiply by three, therefore in order to find the volume of the new bottle you have to multiply the original volume by  $3 \times 3 \times 3$ . Then, the perfume in the new bottle will be  $3 \times 3 \times 3 \times 10 \text{ cl} = 270 \text{ cl}$ .*

Figure 2: A fictitious student's solution for Problem B

In all the activities we asked the students to "think aloud" (Ginsburg, Kossan, Schwartz & Swanson, 1982) while solving the problems.

We did an inductive/constructive analysis (Lincoln & Guba, 1985), since we didn't raise a priori hypothesis, but rather, we generated conjectures from the gathered data. The analysis of the students' strategies and solutions to the problems was not done in terms of "right or wrong". Although conceptions not accepted as correct by the mathematicians can be indicated, the emphasis was on students' thinking processes, without making comparisons, but trying to listen closely (Confrey, 1994).

## RESULTS AND ANALYSIS

In this report we present some results related to the written solutions and the interviews corresponding to Problem B. We selected this problem because, on the one hand, none of the eighteen students solved it appropriately and, on the other hand, we were intrigued by the scant use, by almost all students, of geometrical considerations to solve the problem.

During the first activity in the interviews many students explained that when they were solving the problem, they wondered if the expression "the same perfume", in the statement of the problem was hiding a sort of trick in the sense that the new bottle would also contain "the same quantity of perfume" instead of "the same kind of perfume". They also said that they decided to solve the problem supposing that "the same perfume" meant "the same kind of perfume". Table 1 shows the distribution of the written solutions to Problem B

Solutions	Number of students
Linear	15
Non-linear	2
No solution	1
Total	18

Table 1: Written solutions to Problem B

The most frequent written solution, 11 of the 15 linear solutions, showed the classical scheme for the rule of three, as follows:

$$\begin{array}{l}
 8 \text{ cm} \text{ -----} 10 \text{ cl} \\
 24 \text{ cm} \text{ -----} x = \frac{24 \text{ cm} \cdot 10 \text{ cl}}{8 \text{ cm}} = 30 \text{ cl}
 \end{array}$$

One of the students (Cintia) said:

Cintia: ...I applied the rule of three...if an 8 cm high bottle contains 10 cl, then a 24 cm high bottle would contain another quantity, a greater quantity.

During Activity 2), carried out with those students that solved the problem by a linear approach, they felt self-confident about their answer being correct, and they wondered where the value 270 cl came from, but they didn't change their mind. For example Cintia speculated:

Cintia: I don't know where the 270 [cl] comes from, no, no I cannot imagine it... because maybe he had thought that it [she refers to the enlarged bottle] had the same quantity of perfume, I mean 10 [cl]... maybe he misunderstood 'the same perfume' with 'the same quantity of perfume'.

Interviewer: anyway, do you stick to your answer?

Cintia: yes

In spite of Cintia's self-confidence about her answer, when she was confronted with the fictitious solution presented in Activity 3 (see Figure 2), she immediately laughed and said:

Cintia: he's right, sure, I don't know anything, he's right... of course... because... I calculated it [she refers to the large volume] having in mind only the height of the bottle

Interviewer: what's the problem with that?



Cintia: ... really, it [she refers to the bottle] will not keep the same shape because it will be very narrow and too tall... and what it [the problem statement] says is that it [the enlarged bottle] keeps the same shape, then the shape is proportional...

We could infer from the expression "*it keeps the same shape, then the shape is proportional*" that the student recognizes that the two bottles are similar, in a geometrical sense.

In order to contrast the most frequent and common approach to Problem B, the linear one, we show one of the non-linear solutions we registered for this problem. It comes from Claudina and we show it in Figure 3:

If the bottle has the same shape, then all the dimensions will grow proportionally

⇒ length \_\_\_ triplicate  
width \_\_\_ triplicate

⇒ if I have a bottle  and I enlarge it twice I will have ... then, what I had before fits four times in the new bottle.

⇒ if I triplicate the length, then I triplicate the width. So, what I had before fits 9 times

⇒ the biggest bottle contains  $10 \cdot 9 = 90$  cl

Figure 3: Claudina's solution for Problem B

In this case the student visualized the bottle through a plane figure. Although it was not an appropriate strategy, it could be considered as a first step towards the solution. In this sense her solution is not incorrect but incomplete.

During Activity 3), in the interview, she explained:

Claudina: I had thought like if it were a plane, then in the plane it [she refers to the original bottle] fitted nine times, but I should also have done upward... For example: I have this [she takes a cassette box] and somebody asks me to triplicate this cassette box, then... one, two and three times here, three times upward and three times over there [she refers to the three linear dimensions of the box]

Interviewer: So that's what you interpret when it is said "the same shape but enlarged"?

Claudina: yes, because otherwise it [the figure] will be deformed, I mean, it doesn't have the same shape.

This excerpt shows how the student coped with the fictitious solution. She immediately recognized the omission of a dimension in her analysis and she spontaneously took a cassette box to explain the way the three linear dimensions had to be modified so that an enlarged cassette box preserves its shape. In this way she could visualize the transformation but it worth to note that there was no mention to geometrical similarity and that the expression "*triplicate the cassette box*" means to her that the three linear dimensions are being triplicated which would not be adequate since triplicate a solid could mean triplicate its volume, not their linear dimensions.

## CONCLUSIONS AND DISCUSSION

This study allowed us to: 1) document the presence of the phenomenon among preservice mathematics teachers at university level and 2) confirm the "persistence" as an intrinsic characteristic of the phenomenon of overgeneralization of linear models, mainly in problems with the structure of "three given data and a fourth unknown". This structure conducts to the use of the rule of three as an economical, simple and practical way to solve the problems we posed. These features are some of those that Fischbein (1989) assigned to tacit models. In this sense, we consider that the procedure of the rule of three in problems with the above structure acted as a tacit model.

In particular, the students' decision for using the rule of three in the non-linear context of Problem B could be also related to the fact that the mathematical content (the relationship of volumes of two similar figures), that they need to know in order to solve it, is unfamiliar for them. None of the eighteen students of our study calculated the volume of the large bottle under the hypothesis of similarity, knowing the ratio between the bottles' heights. Most of the students were self-confident about their linear solutions but they were not aware of the proportional model underlying the rule of three. The students didn't validate their written approaches considering, for example, particular familiar three dimensional geometrical shapes for the bottles (a cube or a sphere, for instance). During the interviews, just Claudina considered a

particular case (a cassette box) to explain how the three dimensions of the solid change in order to obtain a similar one.

In spite of the fact that the students in our study have a complex web of mathematical knowledge, procedures and symbolic representations they appeal to the rule of three in order to solve the problems. Maybe this fact is showing that the rule of three as a robust technique learnt in our primary school context should be revisited in the university context from a mathematical and a didactical perspective. From a mathematical point of view it is necessary to make the students aware of the proportional relationship behind the procedure of the rule of three. From a didactical point of view it is necessary to reflect about the existence of linear and non-linear worlds analysing similarities and differences, and encourage the use of some strategies while the students solve problems. For instance, in problems with a dynamical structure, like Problems A) and C) (see Figure 1), construct tables of values or in problems with a static structure, like Problem B, consider the analysis of particular cases like it was suggested above. Both approaches are proposed with the aim of searching a pattern or testing the existence of a linear relationship among the variables.

We think these didactical proposals would help to overcome the phenomenon of overgeneralization of linear models to non-linear contexts among university students, meanwhile they should be considered as conjectures that deserve to be studied particularly considering the students' thinking processes. Finally we point out that, sometimes, the linearity is the "first mathematical approximation" to solve non trivial problems. This is another kind of robustness of the linear model, a mathematical robustness, and we think it should be taken into consideration in future studies.

## References

- Balacheff, N. (1984). French research activities in Didactics of Mathematics - some key words and related references-. *Theory of Mathematics Education ICME 5 – Topic area and miniconferences: Adelaide, Australia*. Bielefeld: Institut für Didaktik der Mathematik der Universität Bielefeld, 33-38.
- Behr, M.; Hare, G.; Post, T. & Lesh, R. (1992). Rational Number, Ratio and Proportion. In: Grouws, D. (Ed.) *Handbook of Research on Mathematics Teaching and Learning*. New York: Simon & Schuster Macmillan, 296-333.
- Confrey, J. (1994). Voice and perspective: hearing epistemological innovation in students' words. In Bednarz, N., Larochele, M. , Desautels, J. (Eds.). *Revue des sciences de l'éducation*. Special issue: Constructivism in Education, 20 (1), 115-133.
- De Bock, D.; Verschaffel, L. & Janssens, D. (1998). The predominance of the linear model in secondary school pupils' solutions of word problems involving length and area of similar plane figures. *Educational Studies in Mathematics*, 35, 65-83.
- De Bock, D.; Van Doorem, W.; Janssens, D. & Verschaffel, L. (2002). Improper use of linear reasoning: an in-depth study of the nature and irresistibility of secondary school students' errors. *Educational Studies in Mathematics*, 50, 311-334.
- De Bock, D.; Van Doorem, W.; Verschaffel, L. & Janssens, D. (2001). Secondary school pupils' improper proportional reasoning: an in-depth study of the nature and persistence of pupils' errors. *Proceedings of PME 25*, 2, 313-320.

- Esteley, C.; Villarreal, M. & Alagia, H. (2004). *Extending linear models to non-linear contexts: an in-depth study about two university students' mathematical productions. Proceedings of PME 28*, 2, 343-350.
- Fischbein, E. (1989). Tacit models and mathematical reasoning. *For the learning of Mathematics*, 9, 2, 9-14.
- Ginsburg, H. (1977). *Children's Arithmetic. How they learn it and how you teach it*. Pro-Ed.
- Ginsburg, H.; Kossan, N.; Schwartz, R. & Swanson, D. (1982). Protocol methods in research on mathematical thinking. In Ginsburg, H. (Ed.) *The development of mathematical thinking*. New York: Academic Press, 7- 47
- Lincoln, Y. & Guba, E. (1985). *Naturalistic Inquiry*. SAGE Publication.
- Van Doorem, W.; De Bock, D.; Hessels, A., Janssens, D., & Verschaffel, L. (2004a). Students' overreliance on proportionality: evidence from primary school pupil solving arithmetic word problems. *Proceedings of PME 28*, 4, 385-392. Bergen.
- Van Dooren, W., De Bock, D., Hessels, A., Janssens, D., & Verschaffel, L. (2004b). Remediating secondary school students' illusion of linearity. A teaching experiment striving for conceptual change. *Learning and Instruction*, 14, 485-501.
- Van Dooren, W; De Bock, D.; Janssens, D. & Verschaffel, L. (2005). Students' overreliance on linearity: an effect of school-like word problems? *Proceedings of PME 29*, 4, 265-272.
- Villarreal, M.; Esteley, C. & Alagia, H. (2005). As produções matemáticas de estudantes universitários ao estender modelos lineares a contextos não lineares. *Boletim de Educação Matemática (BOLEMA)*, Year 18, n. 23, 1- 22.

---

<sup>i</sup> This study was done with financial support from the *Secretaría de Ciencia y Técnica* of the University of Córdoba.



# EDUCATIONAL DESIGN RESEARCH IN MOZAMBIQUE: STARTING MATHEMATICS FROM AUTHENTIC RESOURCES

Pauline Vos<sup>1</sup>, Tiago G. Devesse<sup>2</sup>, and Assane Rassul<sup>2</sup>

<sup>1</sup>University of Groningen, Netherlands

<sup>2</sup>University Eduardo Mondlane, Mozambique

*This article describes a research on learner-centred instruction in Mozambique, Africa. A starting point was the use of real-life resources, such as traditional art craft objects and authentic newspaper clippings. The study used a method which is termed 'design research'. This method aligns theory with practice and is geared towards improving educational practice. In two sub-studies, on geometry and on statistics, learner-centred instruction was facilitated through the use of worksheets with open-ended questions tailored for group work. The designs were tested in cyclic interventions and formatively evaluated through observation reports, interviews and assessment of learners' work. A decentralised, student-centred learning ecology proved to be feasible in overcrowded classrooms, typical in African education.*

## INTRODUCTION

In Mozambique all sectors of education suffer from weaknesses, whether it be primary, secondary or tertiary education. Generally, mathematics education can be characterized by teacher-centred instruction, chorus-recitation, shortages of materials and facilities, un(der)qualified teachers, overcrowded classes, and a curriculum with much theory and few links to learners' lives. As a result, there are cognitive, instructional and affective problems. Regarding the cognitive problems in the mathematics classes, in general, learners learn to memorize formulas and algorithms, needed for the immediate solution of exercises. For many learners, there is neither logical sequence, nor any clear relationship between concepts. Mathematics is taught as a deductive discipline, starting from definitions. For example, the official grade 10 mathematics curriculum document prescribes the drill of formulas, stating that the formulas for area and volume of a cone *should be imprinted by frequent repetitions* (Ministério da Educação, 1995). As a result, learners know mathematical formulas without understanding them, leading to short-term retention and low motivation.

Instructional problems in Mozambican mathematics classes are related to the low number of qualified teachers and to lack of instructional materials. The majority of the teachers in primary education completed fewer than twelve years of education. More than 80% of the mathematics teachers in secondary education are unqualified. The few qualified teachers only teach the highest grades (grade 11-12). Also at tertiary level, most lecturers have a degree equal to the level of the courses they teach. As for the lack of instructional materials, there are few books, teaching manuals and other publications. For governmental primary and junior secondary schools, the Ministry provides schools with officially mandated textbooks, but the

number of copies is insufficient to satisfy the needs of all learners (Mira, 2000). The shortage of books at senior levels forces teachers to use foreign books and make learners copy the content (either from the blackboard or by reading out aloud). With the shortages being structural, teachers have become used to the situation. Even in cases of sufficient facilities, teachers still stick to the routine of orally transmitting definitions and theorems through chorus-recitation.

Mathematics education in Mozambique, like in many other countries, also faces problems in the affective domain. For many learners, the language of teaching (Portuguese) differs from their mother tongue. Also, the content of mathematics education does not link with learners' context. Mozambican learners perceive mathematics as being of little use for understanding the world around them (Januário *et al.*, 2002). They see mathematics as strange, as coming from another world and being imposed upon them. Moreover, many learners live with uncertainty of their abilities and with fear of failure, especially in mathematics.

In this situation, a research in mathematics education was started, aiming at integrating authentic experiences from learners' context with mathematical concepts. The objectives of the study were manifold. First, we wanted to show, that modern Mozambican society is powerful and rich in resources, to such an extent that it can provide mathematics education with many applications. Second, we wanted to create a learning environment, in which the teacher-centeredness was reduced. For this objective we planned to design prototype materials in such a way that whole-class lecturing could be largely avoided, and discussion among learners enhanced. If the materials were well-designed they could set an example for how dynamic classrooms can be organized. Finally, with lesson materials that complied with the mandated textbooks, we hoped to demonstrate that innovative instructional approaches can be embedded within the frame of the central curriculum demands.

## DESIGN RESEARCH

The Mozambican complexity of teaching and learning asked for a research approach, which faces the conditions of learning. Thus, the study was conceived as a *design research*. Design research in mathematics education goes back to the writing by Hans Freudenthal (1991), who explained mathematics as a human activity and who insisted on design research as the core of mathematics education.

Burkhardt and Schoenfeld (2003) also advocate design research. They state that traditional educational research does generally not lead to improved practice, due to lack of credible models. However, an engineering approach to design educational processes leads to refined ideas and materials, which are robust across a wide range of contexts. Also Wittmann (1995) suggested that the tension between research and practice can be eased through the design of *substantial learning environments*, exemplified by arithmetic puzzles that lead to lively classrooms at primary level.

Design research is a methodology that goes beyond the teaching experiment, in which one attempts to establish an existence proof, which shows that 'something' can

be done in class (Lesh & Kelly, 2000). Cobb *et al.* (2003) explain how in design research educational researchers engineer improvement by bringing about new forms of learning in order to study them. They introduced the idea that design research serves to study a *learning ecology*, to emphasize that learning takes place in an environment consisting of interacting systems and not as a set of activities or as a list of factors. A learning ecology contains aspects such as the teacher and his/her instruction, tasks and problems, modes of dialogue, 'norms' for participation in discussions, tools and aids and the way teachers conduct whole-class communication. Using a design approach enabled us to include socio-cultural and situated analyses into the research, going beyond cognitive and psychological aspects.

The current research was inspired by studies carried out in the United States and the Netherlands (Breiteig, Huntley & Kaiser, 1993; Gravemeijer, 1994), in which mathematical modelling activities were tailored as levers for the construction of conceptual understanding. It was guided by the following research question: to what extent can authentic resources be a starting point for assisting learners in the effective formation of concepts. The research comprised two sub-studies. The first focused on geometry at grade 10 level. It started from locally produced art craft objects, such as drums, baskets, huts and fish traps (Figure 1). This study was carried out by the second author (Devesse, 2004).

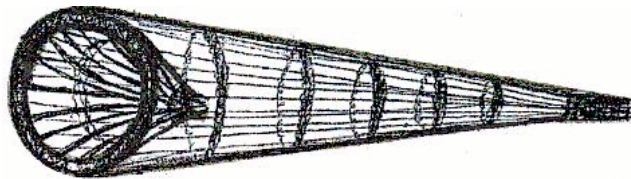

Figure 1: Example of a river fish trap (Niassa Province, Mozambique)

The second sub-study focused on Statistics. It started from newspaper clippings, which were cut from the local daily paper *Notícias* and other Mozambican publications, with themes such as suicide, domestic violence, maize prices and employment. The target group consisted of university students in the Social Sciences. This study was carried out by the third author (Rassul, 2004). The first author was both supervisor and research assistant in the two sub-studies.

## METHODOLOGY

The research was organized in four phases: Analysis, Development, Testing, and Evaluation. In the Analysis phase, contexts of learning mathematics in Mozambique and anticipated problems were analysed. This phase also contained an orientation on the creation of worksheets, a phenomenon generally out of sight in Mozambican education, despite the general availability of photocopiers and printers. In the planned design, most instruction would be conveyed in written form. For inspiration, the second and the third author made a visit to The Netherlands to study the use of photocopies and textbooks as part of instructional methods. When learners work with paper-based materials, classroom communication is no longer centred on the teacher. The contrast with Mozambique was evident.

In the Analysis phase, a number of instructional principles were formulated:

- Mathematics as a human activity, starting from experiences (not from definitions) and developed through worthwhile activities.
- The use of worksheets for group work for facilitating learner-centeredness. The worksheets were to include writing space, giving the researchers written evidence of learners' performance.
- The use of open-ended questions for discussions between learners. Of course, not all questions were open-ended, but we were eager to include a large number of discussion questions into the worksheets. These questions asked for higher order thinking skills.
- The use of abundant authentic pictorial illustrations. Photographs of art craft objects were included for visualization into the geometry materials. In the statistics study, the newspaper clippings were scanned and pasted in their authentic shape into the worksheets. In this way, learners would immediately see that the themes were authentic and not primarily created for educational goals. The authenticity would show them that they were dealing with themes from their own daily life, from their cultural heritage or related to their professional future.
- For the geometry study, which was geared towards a lower level of learning, we included an additional instructional principle: the integration of manipulatives to enable learners to really hold the objects in their hands and learn about mathematical properties through many senses.
- For the statistics study, we included the integration of computers (spreadsheets) to enable the handling of authentic data.

The second phase was the Development phase. This started with gathering inspiration. For the geometry study, typical art craft objects were found at craft markets and at the Natural History Museum in Maputo (the capital city of Mozambique). For the statistics study, a large number of newspaper articles were cut out. Simultaneously, curricula were studied to analyse to which mathematical concepts the resources could be related, and at which level these would best suit for a series of lessons. It was decided that central curriculum concepts in the geometry study would be: cylinders and cones, which are taught from grade 7 onwards. The central curriculum concepts in the statistics study were: mean, binomial distribution, confidence intervals, sample size, and graphic representations. In this phase, we decided on the target groups. For the geometry study, we decided to contact two different lower secondary schools in Maputo and ask whether we could organise interventions at grade 10 level in collaboration with teachers there. Because we came as an external research team, we decided to limit the lesson series to four hours of contact time. For the statistics study, we decided to stay within our own university because the third author is lecturer of Statistics at the Faculty for Social Sciences. He could organise interventions in the second year Statistics course for students of Political Sciences, Anthropology and Sociology, in collaborations with two tutors. The contact time of this intervention could be sixteen hours.

The first prototype worksheets were validated in an expert appraisal with subject specialists. This made us limit the rigor of the terminology (to keep the language accessible) and include the required formula for circumference and area (to avoid memorization exercises). This yielded the second version ready for testing.

The Testing phase comprised an iteration of cyclic interventions. For example, in the geometry study, three different interventions were organised. Each subsequent intervention had a larger scale. The formative evaluation of an intervention led to improvements of the worksheets used in the ensuing intervention. The first intervention was a trial with five learners and served to gain confidence with the approach. The second intervention was carried out in a half-size class (22-25 learners, grade 10). A formative evaluation showed that there were obstacles: the practicability was still insufficient (some learners had no experience with scissors, making some activities cumbersome and some models imprecise), and the efficiency towards learners' understanding needed fine-tuning (learners had a lower level of understanding of cones than anticipated). The first problem was resolved by deleting scissor exercises and adding pre-cut shapes; the second problem was addressed by adding more tasks on comparing different cones.

The final intervention in both the geometry and the statistics study took place in a crowded classroom, typical of African educational contexts (n=55-60), with groups of three to five learners. The observations were recorded in field notes and photographs. Each intervention was concluded with semi-structured interviews with randomly selected learners. The interviews were audio taped and transcribed. In the Evaluation phase, the instructional materials, the observation reports and the interviews were summatively evaluated in light of the research question.

## RESULTS

We ended up with a rich database, of which we can only present a small selection in this paper. The research question asked: to what extent can authentic resources be a starting point for assisting learners in the effective formation of concepts? The interventions showed us, that the authentic resources *in themselves* did not directly ask for mathematical activities. However, these resources were useful as *curtain raisers* in the instructional design. The resources ignited interest and created a link between extra-institutional experiences and mathematical content.

For example, the university students had already studied many newspaper articles, but this had not helped them develop underlying statistical concepts. Now, the worksheets asked them to think beyond a newspaper phrase, for example: “20% of all women have been victim of sexual harassment during childhood”. Students were asked to interpret this phrase and compare probabilities on different samples. This led to the discussion on dependent probabilities and on a required randomness of samples:

“If there are five sisters, and some men in the family are a problem, then you can have (that) all were abused.” (Observations on group work, Worksheet 1, Statistics study)

An example of the discussion on sample size:

“You cannot just put any five women together, and say: one of them was harassed. Maybe not one of them was harassed. Or maybe all were harassed. It is an average, so maybe if you take all women in Maputo, then one in five is harassed. But you will not know which ones.” (Observations on group work, Worksheet 1, Statistics study)

The newspaper articles were rich in statistical resources. They enabled us to design questions that made the learners grapple with underlying statistical concepts. The authenticity of the themes triggered students’ motivation by revealing how statistics matters for their professional future:

Student B (from the Interviews, Statistics study): *The first year Statistics course, it was limited to doing calculations, using formulas and very little interpretation. But these exercises (points at the worksheets) are more involving, because we are studying Social Sciences, and not Engineering or Economics. These exercises are more important than the classical ones, they give a better opening and more understanding.*”

In the geometry study, we observed a teacher holding up a miniature fish trap in front of the blackboard, surprising the (urban) learners with their (rural) cultural heritage:

Episode 3 (from School B, lesson 2, Geometry study):

19. Teacher: Do you know the name of this art craft? Don't you?

20. Students: [in chorus] Noo....o.

21. Teacher: What is the purpose of this traditional object? In certain areas of the country this thing is used as a fish trap. Or as a trap to catch rats. This is called... fish trap.

22. Students: [in chorus] Fish trap.

24. Teacher: Trap, fish trap, just like this one [he shows another model of a fish trap]. This is also a trap for fishing.

22. Students: [in chorus] ... for fishing.

The only mathematical activity that the fish trap model asked for was classifying (it is a cone), but not for further concept formation. However, the worksheets introduced cut-outs making learners relate two-dimensional and three-dimensional shapes and discover rules (e.g. a larger sector yields a lower cone). A principal discovery for many learners was the differences between the height of a cone, and the slanting height (along the lateral surface).

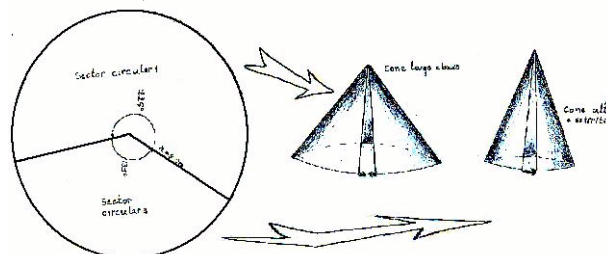

Figure 2: Two circle sectors leading to different cones

One of the exercises made learners discuss how the two cones constituting a traditional fish trap are interrelated, concluded by a multiple-choice exercise, on which sectors could together make a fish trap (Figure 3). With the models given in

their hands, learners discussed intensively, holding the cones top-down, folding and opening the circle sectors again and again. Despite the intensity of discussions, the exercise was only resolved correctly by 60% of the groups.

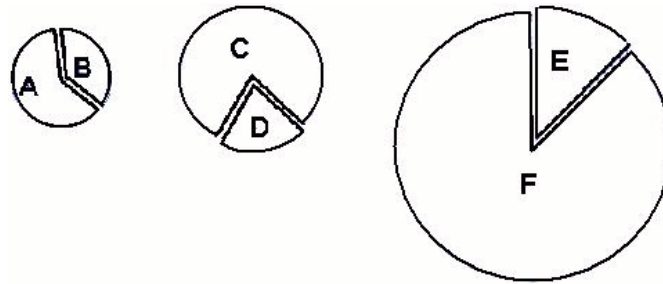

Figure 3: Multiple-choice exercise: choose two circle sectors that together can be folded into a traditional fish trap (answer: B and E)

In the instructional design we had orchestrated separate components, such as the local Mozambican resources together with the group work, the open-ended questions and so forth. The interventions showed us that these components *together* changed the classroom dynamics. Learners could discuss mathematical concepts in their own words because they sat in groups. But the group work would not have functioned as vividly if it were not for the open-ended questions. The open-ended questions triggered interest because their topics were linked to extra-institutional experiences and made available through familiar resources.

As a result, the *learning ecology* changed in many aspects. The groups of learners sat together, working on the tasks from the worksheet. It was the worksheet that instructed them, not the teacher. Thus, the teacher became an outsider of learners' activities. The customary class activities, in which learners follow and copy what the teacher demonstrates, were changed as the learners were assembling each others' contributions within the groups. Here, the mode of dialogue changed, because learners had to explain to each other. The following excerpt shows that it was not always easy to exchange ideas within the groups:

Episode 30 (from the group interviews, Geometry Study):

23. Student A: We saw, we had different ways, but with the same destination. So, one with an opinion, another with an opinion,.....we continued to discuss, and then in the end we saw that the destination was the same!
24. Researcher: (..) Is there more? Yes, please.
25. Student B: We spoke of the same thing but with different words. There was some confusion when we wanted to say things...we said one thing...they used a different word to say the same thing. So it was difficult the discussion.

## CONCLUSIONS

In this report we have presented a design research in mathematics education in Mozambique, in which shared principles were applied in two completely different settings, respectively at junior secondary and at tertiary level. Our starting point demonstrated that modern Mozambican society is rich in resources, to such an extent that it provides mathematics education with many applications. However, the resources lead to concept formation only in conjunction with a number of

instructional design principles (starting mathematics from the applications; worksheets with open-ended tasks for group work; many illustrations). The design conveyed a learning environment, in which the central role of the teacher reduced. Whole-class lecturing could be largely avoided, and discussion among learners enhanced. Pivotal in the design was the worksheet, which decentralised classroom communication and facilitated group work. This effect did not automatically emerge from the use of traditional art craft or newspaper clippings.

The interventions in this research were atypical and small-scale, yet successful in the Mozambican context of (over-)crowded classrooms. The combination of authentic resources as a starting point for concept formation and instructional design principles proved robust. These research findings could strengthen the Mozambican policies that advocate educational innovations towards more student-centeredness. Nevertheless, the large-scale enactment of these policies still has a long way to go.

## References

- Breiteig, T., Huntley, I. & Kaiser-Messmer, G. (eds.) (1993). *Teaching and Learning Mathematics in Context*. New York: Ellis Horwood.
- Burkhardt, H. & Schoenfeld A. (2003). Improving education research: towards a more useful, more influential and better-funded enterprise. *Educational Researcher*, 32(9), 3-14.
- Cobb, P., Confrey, J., diSessa, A., Lehere, R. & Schaubele, L. (2003). Design Experiments in Educational Research. *Educational Researcher*, 32(1), 9-13.
- Devesse, T.G. (2004). *Exploring the Potentials of Locally Produced Artcraft Objects in Teaching Secondary School Geometry*. Unpublished M.Ed. thesis. Maputo: UEM.
- Freudenthal, H. (1991). *Revisiting Mathematics Education*. Dordrecht: Kluwer.
- Mira, F. (2000). *Educação, Empresas e Desenvolvimento em Moçambique*. Évora: Pendor.
- Gravemeijer, K.P.E. (1994). *Developing Realistic Mathematics Education*. Utrecht, the Netherlands: CDβ Press.
- Januário, F., Matos, E., Camundino, V. & Filomone, J. (2000). *Estudos Sobre Cenários de Ciência e Tecnologia nos Currículos*. Maputo: MESCT.
- Kelly, A.E. & Lesh, R. (2000). *Handbook of Research Design in Mathematics and Science Education*. Mahwah, NJ: Lawrence Erlbaum Associates.
- Ministério da Educação (1995). *Programas da Matemática: 1º ciclo*. Maputo: Author.
- Rassul, A. (2002). *Exploração de materiais instrucionais produzidos com base em artigos de jornais para o ensino da estatística*. Unpublished M.Ed. Thesis. Maputo: UEM.
- Wittman, E.Ch. (1995). Mathematics Education as a “Design Science”. *Educational Studies in Mathematics*, 29, 355-374.



# “THE BIG TEST”: A SCHOOL COMMUNITY EXPERIENCES STANDARDIZED MATHEMATICS ASSESSMENT

Fiona Walls

James Cook University, Australia

*Standardized testing in primary school mathematics is widely used as a monitoring device in education systems world-wide. This paper uses Foucault’s notion of assessment as a technique of power, to examine how members of one Australian school community experienced the annual compulsory standardized Year 5 Aspects of Numeracy Test. The paper examines the ways in which the “numerate” child is inscribed within the “normalizing” apparatus of standardized assessment.*

## INTRODUCTION

Standardized testing of literacy and numeracy skills of primary school students has become a common method of assessment in Australia. It is widely accepted that such tests are objective and reliable, providing essential information for the provision of quality education. Wiliam, Bartholomew & Reay (2004) challenge such claims:

“For the most of last century, educational assessment derived its principal research paradigm from psychology...the creation of tests and other forms of assessment has been regarded as an essentially technical and objective undertaking although there has, during the last quarter-century, been an increasing acceptance that educational assessments have social consequences –people change what they do because of assessments.” (p. 43)

In examining UK secondary school students’ experiences of the SAT (Scholastic Aptitude Test), Wiliam et al demonstrate a powerful relationship between assessment, learning and pupil identity, arguing that test performance plays a significant part in students’ “becoming” as mathematical subjects and in determining the shape of students’ learning trajectories.

This paper reports on research that also investigated relationships between standardized assessment and pupil identity. The research gathered the accounts of children, parents, teachers and managers of one primary school community who reported their experiences of the 2005 Queensland Year 5 Aspects of Numeracy Test.

The specific purposes of the Years 3, 5 and 7 tests are “to collect data from the population of Years 3, 5 and 7 students for reporting to parents/carers and schools for systematic reporting,” and, “to accommodate the assessment of students against national benchmark standards” (Queensland Studies Authority, 2005a). All eligible children in Queensland are required to take part, with exemptions granted only in exceptional cases. The test is administered within classrooms in the manner of an examination. Teachers guide the children through the two-hour test following a prescribed script and adhering to strict time allocations. The test is of the pencil-and-paper type with over half of the forty-two questions structured in a multiple-choice format, and the remainder requiring digits to be written in answer boxes.

---

2006. In Novotná, J., Moraová, H., Krátká, M. & Stehlíková, N. (Eds.). *Proceedings 30<sup>th</sup> Conference of the International Group for the Psychology of Mathematics Education*, Vol. 5, pp. 353-360. Prague: PME. 5 - 353

## Walls

Although its authors claim the test assesses children's thinking, reasoning and working mathematically (The State of Queensland (QSA), 2005a), the test does not ask children to explain or justify their answers. This method of assessment assumes correct answers match "correct" thinking, which in turn indicates sound mathematical understanding. Mathematics education researchers who have investigated such tests (e.g. Ellerton and Clements, 1997) claim a question/answer/understanding mismatch rate of as high as 30% and argue that the tests are unacceptably unreliable. This method of assessment continues to be used by Education Queensland as the primary source of statewide data about children's achievement in primary mathematics.

Children's test results were reported as dots on horizontal scales, pinpointing overall achievement as well as achievement by the separate mathematics strands of Number, Measurement & Data, and Space, as shown in Figure 1 below. The dots positioned the child's test score relative to the state average (solid line), the "middle" 50% of scores in the state (shaded box), and Australian national benchmarks (dotted line). On the example below, the hypothetical child has scored above the state average for both measurement and number, below the state average for Space, but within the middle 50%, giving an overall score slightly better than the middle 50%.

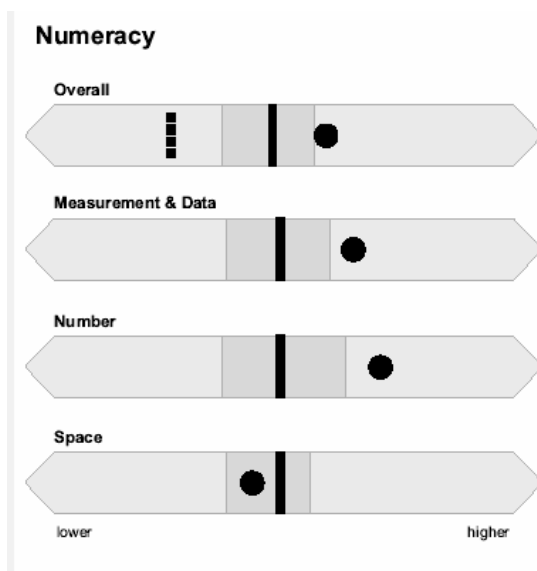

Figure 1: Sample of Numeracy Test results (The State of Queensland (QSA), 2005b)

## THEORETICAL FRAMEWORK

This paper investigates how such standardized assessment might operate in the production of the child as "numerate". It draws on Foucault's theories of power, knowledge, and the discursively produced subject (Foucault, 1994) that researchers have found useful in investigating issues of pupil identity in mathematics education (e.g. Walkerdine, 1998; Walls, 2004, Cotton, 2004). The paper uses Foucault's suggestion that measurement and classification operate as apparatuses of recognition and normalization. Foucault (1970) looked to historical sources to understand how human systems of classification over time and across differing cultural settings have been concerned with "noticing", "describing", "defining" and "ordering". He argued that classification systems structure our world view, and that classification of the "self" has become a pervasive managerial technique within institutions such as

schools, whose purpose it is to *correct* or *train*. In measuring, classifying and ordering our “selves” according to matrices of normalization such as levels, stages, benchmarks and standards, we make it possible to delimit, proscribe, admit passage, or debar. Foucault (1977) described the test or examination as the mechanism central to the process of classification of “selves”:

“The examination combines the techniques of an observing hierarchy and those of a normalizing judgment...It establishes over individuals a visibility through which one differentiates them and judges them. That is why, in all the mechanisms of discipline, the examination is highly ritualized. In it are combined the ceremony of power and the form of experiment, the deployment of force and the establishment of truth. At the heart of procedures of discipline, it manifests the subjection of those who are perceived as objects and the objectification of those who are subjected.” (pp. 184-185)

Foucault regarded schools as disciplinary institutions in which, “The perpetual penalty that traverses all points and supervises every instant...compares, differentiates, hierarchizes, homogenizes, excludes – in short, *normalizes*” (Foucault, 1977, p. 183). In this view, schooling acts as a discursive domain productive of “ability” such as the “numerate child”, created and maintained through a framework of assessment practices of which the standardized test is an essential component.

## METHOD

This research sought to reveal the complexities of the social dimensions surrounding the classifying and normalizing apparatus of one measure of numeracy, the standardized Queensland Year 5 Aspects of Numeracy Test. The research was conducted within a large suburban Queensland school. Perspectives were gathered from members of the school community, including children, parents, teachers and school managers. The school community was investigated as a site where, at the capillared extremities (Foucault, 1997) of a centralized education system and within the contingent arenas of school and family, children might be *produced* as “numerate subjects” through the classifying mechanisms of the test.

The research was based on the *critical collaboration* model described by Atweh, (2004) and the *critical analytic* approach described by Freebody (2003), whose key concepts are the provision of multiple ‘voices’, the location of the research process within authentic accounts, and an emphasis on the *process* of research activity as much as the *outcomes*. The research involved gathering participants’ experiences of the test by means of informal conversation immediately after the test had been administered, and again just after the results had been received. It was conducted in four phases: (a) orientation in which the researcher spoke with school managers, reviewed the test preparation materials and observed one class sitting the test; (b) post-test conversations with teachers, children and parents which were audio-recorded and transcribed; (c) transcript review in which transcripts were returned to participants for comment or amendment; (d) post-results conversations with teachers, parents and children. Participants’ conversations were reviewed for statements that might provide evidence of Foucault’s contention that examinations operate to *normalize*: that is, to *compare*, *differentiate*, *hierarchize*, *homogenize*, and *exclude*.

## RESULTS

The children spoke of the test as an extraordinary event in their schooling within which they became separated, measurable, and individual performers.

Ana: We couldn't sit near to each other; we couldn't open our desks, or get out of our chairs, or anything.

Ari: At the beginning I was struggling, but I had some water and I could do it better.

They spoke of the test as a highly charged emotional experience which they approached with excitement and apprehension. Excitement was linked to the possibility of rewards gained from "doing well" while anxieties were linked to the possibility of punishments for doing badly such as losing face in front of friends, parents or siblings, loss of privileges at home, or being kept back.

Chloe: I'm feeling a bit excited. Because they (teachers) said I'd probably do well.

Perry: I was so excited to do the test, I thought about my Mum and Dad and my family, if I do well, what would they say and everything, if I got a good mark...All I'm worried about is getting some money taken off me or something if I get a bad mark...I get stuff taken off me or lose money or get grounded.

Chris: I had butterflies. I didn't even want to do the test...I was like, "Oh my God, please be good, please be easy"...I don't want to get my results...My mum and dad says that if I don't get over 10 or 11, I have to do Year 5 again.

Sally: I felt sad that I wouldn't do really well.

Children talked about the purpose of the test. Their statements show that they believed the test to be an inevitable and essential part of their schooling; without its *differentiating* and *comparing* judgements, they would be unable to learn, progress, or make it in the world beyond primary school.

Ana: I think to see what level we're at, you know

Kim: If you get all the test wrong or you don't do a test, then you won't learn for next year. It's like a cycle...And if you didn't get a good result out of it, that means that we didn't learn much in Grade 5 so we should stay back

Tony: My mum said, "Don't worry 'cause it's not going to affect your life... (Dad said) "You probably won't get kept down."

Chris: It actually does affect your life, if you don't go really good, it affects your career.

Perry: Some people won't get jobs they want because they won't know as much.

Zarn: The test is important. [If you missed the test] people wouldn't be able to find out how they went...so the teachers won't know how much they know, what to do in case they need to be kept down or need to do more maths.

These statements contain evidence of the children's understanding of the test as part of a process of *differentiating*, *including* and *excluding*, but also of *homogenising*; the need for those who fail to "stay back" or "do more maths" in order to close gaps and meet needs; ideally, within the same curriculum everyone reaches the same standard.

The children explained their reading of the results (refer Fig 1). While some struggled to make sense of the graphic representation of their performance, their statements show that they understood the test to be *comparing*, *differentiating* and *ranking*:

- Adele: I think I did pretty good...I saw that and I thought, "Wow!"...I'm off the graph.
- Tony: I got all mine in the higher place...they're like the highest grade.
- Bart: I got over the...(points to the line indicating the state average).
- Kim: It means what rating you got. And that's like the middle line (pointing). And, I don't know what that darker square is, I think it's not low, but "before low". [I feel] Bad...pretty sad...I thought I would have done better...'cause it was pretty easy and I knew all the maths.
- Perry: Well I'm very good at Space, and Number I'm OK at. Measurement & Data I'm not that good at it. Overall, yeah, I'm good... I thought I'd be better at Number than Space. But now I've found out that I'm better at Space than Number.
- Ari: (Pointing to each of his dots in turn) Well that's like, "*all right*", and that's, "*good*," and that's "*all right*," that's my guess...'cause at my old school I didn't get this, I'm used to getting numbers, marks...
- Britta: I wanted to be a bit higher.

Reading the results was a social process. Interactions with family, peers and friends helped children to gain a sense of the *worth* of their results. Comparisons proved affirming for some, but distressing for others:

- Ana: My friends said they're good [results]...I've got two [dots] low and that's in the middle, and I don't know about that one (indicates 'overall' category).
- Sally: She (identical twin sister) got higher than me. Simon (younger brother) got high in everything... He can pick it up straight away and for me and Ingrid we have to keep on working for it...I didn't want Simon to look at mine because I didn't want him to see he was better than me... Yeah, I've never been good at maths.
- Bart: I don't think Martin's (classmate) maths [result] is going to be very high. He's not good at maths. I'm good at maths.

Teachers' statements revealed not only concern about the *comparisons* created by the test, but also the pressures they faced in preparing children for the test, revealing how their teaching behaviour changed to optimise children's performances.

- Allie: There are percentages of these tests where some of it is baseline and then it gradually gets harder to let those children who are very bright, shine. I just find that very frustrating for the children who aren't the shiners.
- Dan: You do to a point have to teach to the test, just to get them used to the process of doing one...it's a stress to make sure that you've covered everything.
- Col: We talk about pressure on the kids but also on the teachers as well... we've got to prepare for this because you're not giving the kids the opportunity to show their best...to me it rearranges my teaching format, you've got to do bits of everything to ensure that they get a range.

## Walls

*Comparison, differentiation, hierarchization and exclusion* were recurrent themes in the parents' accounts. Test anxiety and feelings of failure were poignantly described. Their accounts of exclusion show how *homogeneity* emerged as a desired state – if testing *excludes*, then corrective action is needed to ensure that no child is left behind.

- Ursula: When she (daughter Sally) does these tests, she gets really, *really* stressed...She ends up in tears, it's not worth it because it highlights her ability, her weakness, which is maths...We got her results back yesterday. Sally was pretty upset...Crying. I tried to explain to her that it didn't mean as much as her general report card because the teacher knows what she's been doing through the year. But when she saw that her dots were all below in everything, she was very upset...her brother's in Grade 3 and he was off the scale which makes them feel inferior...it causes friction between the siblings, and embarrassment, like yesterday I was doing Ingrid's (Sally's identical twin sister), I look at their reports individually, and Ingrid was sitting there and telling Sally to go away [saying] "I don't want you to look at mine". But what happens where they've got an overall rating that's below the benchmark? There's got to be a purpose to this testing, to put kids through the stress and then just leave them there. There should be extra tutoring or something, they should be trying to get them up there.
- Marlene: Britta (daughter) stresses about the test to begin with...and then for her to be able to compare it with other kids and to see she's not doing so well is really upsetting to her...they started talking about it in Term 2 and she started building up from there. "It's that big one again, Mum...it's all of Queensland." She'd looked at [the test results] at school and seen other kids', and she said, "Mum, mine was lower than my friends and that was really bad." That was quite a shock for her to open it in front of other kids, who've gone, "Look where your dot is!"...She just sees it as, "I'm not even in the middle"...I don't really want to know where my child is as a dot in Queensland...My child's not a dot. The comparison I don't think is fair. I just don't think it's something that the kids need to go through.
- Carol: We're very proud of (daughter) Adele's results. She's got a high level for everything, but Leo (son) sat the Year 3 Test and we're very disappointed with his results...if that's the benchmark, he's back here, he's behind the eight ball.
- Tina: She (daughter Zarn) did really, really well on her results... this is probably surprising (points to lower Number result) and that she'd be off the graph of what they'd expect (points to Measurement & Data)...They need to have a standard that they can reach... I think that's what is important about the Numeracy testing is they actually find out where they're sitting with the state.
- Olivia: Chris (son) thinks he's no good at maths. His result's just above the middle line, so he's actually in the higher side of the average...His dad said, "Mate, you can't tell me you're no good at maths...It makes a lot of difference with Chris's results to my oldest son; he was well below the state average in everything.
- Marie: He (son Andrew) thought he did better in Numeracy than Literacy, he said he thought the Numeracy was easy, but it was the other way around. So I wonder, are these results really Andrew, or was it just him panicking on the day? He's a little sad that Charlie (younger brother) may be a lot quicker than him at maths. Charlie did really well (on the Year 3 Test). I haven't shown him Charlie's

results. I don't want them to compare, but it's how to talk to him about it...I can't pinpoint what went wrong so I can't help him.

The school manager's views were summed up in the following statement.

Principal: It's about schools, getting data about trends to improve performance and it's about systems, so it's very political. At the coal face when you've got these little Year 3s doing this test and getting anxious about it, or we had one Year 5 and he was away in Year 3 when they did test and he was very anxious because he'd never done one of these before, and going through the whole trauma and then knowing it's not actually about helping your child, it's a game, they have to jump through the hoop, but it's not going to benefit them; it's hard to justify as an educator...we need to be honest about the purpose of the test, what the audience for the results are, and the audience is not really the parents, it's not the students, its hardly for teachers...It's for administrators and the school.

## CONCLUSION

The conversations of the participants in the research reveal that the Years 3, 5 & 7 Aspects of Literacy and Numeracy Tests loomed as a major event in school and home life in its perceived authority to tell the truth, that is, to objectively measure and rank each child. In this perception, school management and teacher behaviour were modified, pupil identity reworked, and relationships within families adjusted.

In mathematics education in Australia, "normalizing" classification through standardized testing begins in early primary school, measures children according to state or national standards and benchmarks, and is linked to the politically significant international studies. In this way, the mathematical achievement of every child in Australia can be documented and tracked. Through such a regime, the "numerate child" becomes a subjected entity made visible for teachers, parents, and policy makers. Within the establishment of a numerate norm, the "innumerate child" and the "exceptional child" are also brought to life. For the subjects who are thus objectified, beliefs about mathematics, cognition, affect, and identity become entwined, as Britta, whose test results were not what she had expected, so clearly articulates:

Britta: I don't like maths, it's not fun, but I do my best...sometimes it's confusing... I thought maybe, if I done [the test] again, I probably could have done it better than I did, could have answered the questions.

With little choice but to accept the judgement of the test and its identification of her as less-than-acceptably-numerate, Britta still tries to resist its condemnation by retaining the hope that she "could have done it better". Inscribed by the "normalizing" processes of obligatory state testing, Britta's enjoyment of mathematics and her faith in her mathematical abilities have been eroded.

The research showed that irrespective of how "well" the children "did", the test contributed significantly to their *becoming* as mathematical subjects. Children, parents, teachers and school administrators all grappled with the test's licence to create a normalizing "truth" (Foucault, 1970). In light of the limited information the test elicited about children's mathematical thinking, and in view of the questionable

## Walls

validity of the test, the inappropriate and disproportionate capacity of the test to compare, differentiate, rank, homogenise, exclude and “normalize” must be rigorously challenged. Further community-based research of this nature is necessary.

## References

- Atweh, B. (2004). Towards a model of social justice in mathematics education and its application to critique of international collaborations. In I. Putt, R. Faragher & M. McLean (Eds.) *Proceedings of the 29th Annual Conference of Mathematics Education Research Group of Australasia*. (47-54) James Cook University, Townsville: 2004.
- Cotton, T. (2004). What can I say? What can I do?: Archaeology, narrative and assessment. In M Walshaw (Ed.), *Mathematics education within the postmodern*. Greenwich CT: Information Age Publishing.
- Foucault, M. (1997). *Society must be defended: Lectures at the Collège de France, 1975-76*. Translation, 2003. London: Penguin Books.
- Foucault, M. (1994). Power. J. Faubion (Ed.), *Essential works of Foucault 1954-1984, Vol 3*. London: Penguin.
- Foucault, M. (1977). *Discipline and punish: The birth of the prison*. London: Allan Lane.
- Foucault, M. (1970). *The order of things: An archaeology of the human sciences*. New York: Random House Inc.
- Foucault, M. (1969). *The archaeology of knowledge*. Routledge Classics Edition, (2002). London: Routledge.
- Freebody, P. (2003). *Qualitative research in education: Interaction and practice*. London: Sage.
- Ellerton, N. & Clements, K. (1997). Pencil-and-paper tests under the microscope. In A. Begg (Ed.) *People in mathematics education. Proceedings of the 20th Annual Conference Mathematics Education Research Group of Australasia*. Rotorua: (155-162)
- The State of Queensland (QSA), (2005a). *2005 Queensland Years 3, 5 and 7 Tests in Aspects of Literacy and Numeracy: 2005 Test preparation handbook*. Brisbane: The State of Queensland (Queensland Studies Authority).
- The State of Queensland (QSA), (2005b). *Queensland Years 3, 5 and 7 Tests in Aspects of Literacy and Numeracy: 2005 Test reporting handbook*. Brisbane: The State of Queensland (Queensland Studies Authority).
- Walls, F. (2004). The “mathematically-able child” in primary mathematics education: A discursive approach. In I. Putt, R. Faragher & M. McLean (Eds.) *Proceedings of the 29th Annual Conference of Mathematics Education Research Group of Australasia*. Townsville: 2004.
- Walkerdine, V. (1998). *Counting girls out: Girls and mathematics*. New Edition. London: Falmer Press
- William, D., Bartholomew, H. & Reay, D. (2004). Assessment, learning and identity. In P. Valero & R. Zevenbergen (Eds.), *Researching the socio-political dimensions of mathematics education: Issues of power in theory and methodology*. (43-61) Dordrecht: Kluwer Academic Publishers.



# NUMERACY REFORM IN NEW ZEALAND: FACTORS THAT INFLUENCE CLASSROOM ENACTMENT

Margaret Walshaw  
Massey University

Glenda Anthony  
Massey University

*This paper explores numeracy reforms in New Zealand schools. We investigate factors that contribute to the way in which teachers interpret and adapt numeracy reforms within their classrooms. In explaining two teachers' differential practice we advance the notion that changed practice emerges and evolves within the dynamics between teachers' personal resources and school-wide processes.*

## INTRODUCTION

Recent numeracy reforms in New Zealand (Ministry of Education, 2005) require teachers to do things differently in mathematics classrooms. From evaluation reports of the New Zealand Numeracy Development Project (NDP) (e.g., Higgins et al., 2005) we know quite a lot about students' attainments in the numeracy enhancement initiatives. Yet we know little about how schools and teachers have managed the change associated with the reforms. We were interested in finding out what factors influence teachers' enactment of numeracy reforms.

At the heart of our investigation was a desire to understand precisely what schools and teachers do to actualise the intent of the reforms. We did have some promising guideposts from other countries. From a major study undertaken in the UK (Millett, Brown, & Askew, 2004) we knew that school-wide systemic change that aligns with the reform is an important factor in facilitating teachers' changed instructional practices. Principals in that investigation who were respectful of the professional expertise and change intentions of the school's mathematics teaching community made a difference, through both personal support and systemic school-wide change. Lead mathematics teachers, too, were key players in sustaining the project. They influenced 'how' and indeed 'if' the reform ideas were taken up by staff. Bobis (2004) has found that support from within the institution and the broader school community was a critical feature in influencing teacher development and enhancing student learning. In her evaluation of the impact on teachers of the "Count Me In Too" numeracy programme in Australia, Bobis reports that successful teachers were supported both practically and emotionally and worked within a professional context of shared knowledge and shared thinking about what counted as effective instruction.

## THEORETICAL FRAMING

If numeracy instructional practices are enhanced from teachers' active engagement with processes and people, then we want to have a clear idea about how people and systems work to effect change. How exactly do teachers work with the project? In attempting to address the question, we move away from the notion of the teacher as the sustainer of the project to one in which the teacher is an *interpreter* and an

---

2006. In Novotná, J., Moraová, H., Krátká, M. & Stehlíková, N. (Eds.). *Proceedings 30<sup>th</sup> Conference of the International Group for the Psychology of Mathematics Education*, Vol. 5, pp. 361-368. Prague: PME. 5 - 361

*adaptor* of curriculum (Shulman & Shulman, 2004). In doing this we are integrating two lines of investigation: one that focuses on the role of professional development in supporting teachers' reorganisation of their instructional practices and their views of themselves as learners; and the other that investigates the structural or organisational systems within schools.

Our investigation explores the interplay of teachers' personal resources with the 'external' incentives made available for teachers to engage with the NDP. Precisely because professional development takes place within nested systems of people and structures in schools, we have embedded institutional settings into the analysis of teachers' personal enactment of numeracy reforms. A theoretical underpinning for our approach can be found in Vygotsky's development of the social dimensions of learning and the way in which that learning might be mediated by tools. In terms of teachers' numeracy enactments in classrooms, those tools are taken as the support within the school community and the resourcing of the programme.

Central to our position is the co-dependence of people and things. For us, change emerges and evolves within the dynamics of the spaces people share and with whom they participate. In this theorising, teachers are professionals who modify and transform their instructional practices in a generative fashion; they accommodate reform efforts in relation to the affordances made available by wider social contexts. We draw on these ideas to account for the visions, commitments, motivations and capacities that are both held by individuals and shared by the learning community.

## METHODS

At a time when policy drives are focused on sustaining the NDP, we wanted to explore how school personnel interpret and adapt the comprehensive numeracy strategies. We wanted to investigate those factors that relate to individual teachers themselves, to the community of teachers they work with, and to their school community that, taken together, contribute to the 'take up' and continuance of classroom practices mobilised through teachers' participation in the Project.

We explored teacher change through a school case study approach. Given that a focus in the project was to identify those factors which appear to facilitate or inhibit the development of numeracy teaching practices, we looked at groups and individual teachers within six schools, all of whom had completed the programme at least two years ago. In each school we interviewed a range of school personnel. In particular, we spoke with numeracy classroom teachers, lead mathematics teachers, school principals, teachers who were new to the school and any other staff who sought an interview. Our list of questions was extensive and open. We found that school personnel were keen to respond to our questions, sometimes with unexpected revelations about the relation between people and systems.

We provide here an insight into the approach taken by two schools in getting 'on board' with numeracy reform ideas. We examine these two cases to highlight the interplay between external incentives with teachers' personal inclinations to enact the

reforms. The hope is that in investigating the interplay of teachers' personal resources with 'external' incentives some valuable conclusions about how reform efforts are interpreted and modified might be drawn. Understanding this interplay is vitally important during the current period of mathematics reform.

## ENACTING THE REFORMS

Coordinated at a national level, the aim of the NDP is to raise student achievement through raising teacher capability. Numeracy facilitators work to improve content and pedagogical knowledge, explaining new ways of doing things, guiding planning and offering teaching episodes to capture the intent of the programme. These are provided in a model that uses both on-site workshops as well as in-class teaching demonstrations and provides assistance with planning and decision making concerning the selection of problems and activities for classroom work.

### Rowena's School

Rowena is a veteran teacher and has been teaching for 27 years. "I wasn't confident in maths when I first started. I think I'm feeling pretty good about it now because I've been through it, you know, I've had the time to sort it out. I know the activities that work for me and how I want it to be done." To construct alternative practices, Rowena said: "I knew that there would have to be changes because there always is when new systems come in. You've got to make changes and you've got to rethink things that you are doing." Like all schools involved in the NDP, Rowena's school took the intent of the programme seriously and had made a significant commitment to it in terms of finance, time and resourcing. School-wide expectations and accountability measures at her decile<sup>1</sup> 3 school to some extent pressed her to attend carefully to the reform proposals. Her principal noted that "twice a year we collect information from school-wide assessments and from that we set out targets. At Year 8, I want them to be at a certain stage. I looked at our data and thought that's not good enough for them to be going off to high school."

Rowena believed that the project had made a positive impact in her classroom and was convinced that her enactment of the programme was consistent with the programme's intentions. Through her efforts to reform practice she had developed a new vocabulary consistent with the language in the project. The vocabulary that organised her new teaching and learning experiences (e.g., 'strategies', 'tens frames', and 'the abacus') tended, however, to capture the 'tools' rather than the 'big ideas' of the reform rhetoric itself. She engaged not so much with the core ideas about practice in which the numeracy reform is grounded, as the activities that accompany those ideas. Getting on board for her meant attendance at the professional development sessions and adding the new resources and activities into

---

<sup>1</sup> Decile ranking (1-10) in New Zealand schools is assessed from Census data and from school ethnicity data. A low decile ranking is an indicator that the school community is formed from low socio-economic communities. High decile schools record the highest proportion of students from high socio-economic communities.

her teaching repertoire. The biggest change, she noted, “was accepting that I didn’t have to see every group every day. And I feel I am doing better teaching that way because I’m not cramming.”

Rowena’s principal explained how the school had organised extensive support for teachers in her school. Professional support was centred initially on an expert working in isolated classrooms and modelling lessons. Support didn’t stop there: the expert “came back to check on teachers. We had a teacher who wasn’t fulfilling the obligation and she came and worked alongside that teacher.” It wasn’t just “go off, have a day and then go back and do it,” she explains. “There was that on-going thing.” Colleagues as well as expert facilitators were central to the school’s reform efforts. Still centred on the classroom, a school-wide system was developed whereby individual teachers chose one senior teacher in the school to “come in and observe a specific aspect of the mathematics programme that the teachers decided on.” Feedback was provided immediately afterwards. As the principal says, “that way we’re actually continuing the professional development.” Peer support and feedback not only allowed teachers to sort out pedagogical or content problems, it also provided teachers with the motivation to improve their practice.

Enactment of numeracy reforms at Rowena’s school went beyond individual classrooms. As the school lead mathematics teacher explains, they took a whole school approach to professional development: “We share across the school the different things that we were doing. And so we did things like that to help our planning and to help our organisation.” Collegial feedback on practice as well sharing individual attempts to enact the proposals in their classrooms created incentives for teachers to revise their practice. They also created incentives to formalise their ideas about effective practice. From their team meeting deliberations the teachers had produced a document that captured their collective ideas about effective numeracy classrooms. The schedule established for them the characteristics of effective teaching and the numeracy learner, as well as the features of the environment. This document resulted from ongoing personal deliberations that were grounded in understanding the reform ideas relevant to their particular students.

### **Cherie’s School**

Cherie had been teaching for “thirty plus years” and had “seen many changes in the maths programme” over that period. Like Rowena, she tells us that she has a “very weak background in maths.” It was not until she enrolled in curriculum studies in mathematics at Teachers College that she “began to understand the functions and the processes of maths much better.” For Cherie the Numeracy Project was a major shift in thinking and action for some teachers. She pointed out that the school had to reorganise its school-wide programme to accommodate the reformers’ bidding. As at Rowena’s school, accountability measures drove practice. The principal of her decile 7 school noted that the school compared their numeracy data with the national figures. He noted too that “at the end of each year we have a record of where each child is at.”

Although Cherie's own personal school experiences in mathematics were weak, the programme "built on [her] own philosophy of how children learn." Cherie pointed out that her past teaching practice approximated the reforms. For her personally, the programme required less unlearning of old practice and confirmed that what she "was doing was okay." For example, she said that the strategies for developing number sense were simply "what I do myself, so it was logical to be able to teach them to the children." She claimed that the project "was just an extension of what I was doing, only more organised. It gave me lots more ideas and opportunities to use what I was already doing." In short, the programme was not so much a fundamental shift in thinking on her part, but one that "provided new outlets for what she was already doing in the classroom." The main difficulty for her now lay in the organisational part in sourcing activities and games for her numeracy class.

Cherie demonstrated her familiarity with the fundamental reform themes through a vocabulary that was consistent with the language in the project. The reform rhetoric became a key tool for organising new teaching and learning experiences and played an important role in constituting the realities of her classroom practice. During her interview she talked about 'early additive', 'advanced counters', 'diagnostic interview', 'flip numbers', 'the abacus', 'the slavonics', 'tidy numbers', 'number lines', 'doubles', 'tens frames', 'number fans', 'hundreds board', 'making up to tens', and 'strategies'. Cherie, more than Rowena, had assimilated the vocabulary into her own thinking and drew upon that language to represent her ideas about her practice.

In marked contrast to Rowena's experience, Cherie reported no sustained guidance for her classroom work. She noted that there were very few deliberations about practice and discussions about the ways in which the reform ideas might be enacted. Typically the work that Cherie did in her classroom was not known about or discussed in the staffroom or at team meetings. In effect, teachers were practising in isolation in their classrooms. As she said: "I don't know about the others [teachers]...I'm probably missing out heaps of stuff I should be doing, but hopefully I'm trying to cover what I can and do the best I can." Cherie tended to compensate for the lack of collegial support by making use of the NDP on-line "number site". For her the site is "really good. Really helpful for me because the lesson plans are all set out." What she would like are continuing discussions with colleagues and the opportunity to share ideas about and enactments of practice. These observations were echoed by a new teacher at the school who believed that "you've got to be talking with other people who are doing it."

Ultimately it is the principal who makes the decision about committing to the project. The principal at Cherie's school was prepared to commit "a lot of money" provided it offered a "better school direction" than the topic approach to mathematics that was in place in the school at the time. He wanted it to meet the needs of the children. He attended the seminars held at the school to hear what the project offered for his particular school community. In his understanding, "the biggest change is the strategies." For him, the project allowed teachers to see "the children engaged in their learning. Doing the things that they need to know—the knowledge that they need but

also the strategies that they need.” He suggested that “there’s more emphasis on the children or teachers knowing exactly where each child is working. And so the group dynamics, if you like, cater for those needs.” Apart from meeting the needs of children, the project “was something new and we wanted to be part of it.”

Based on the principal’s understandings of the project, classroom release for the lead teacher was subsequently arranged and it was the lead teacher who coordinated the programme and worked with “parents in group situations making equipment.” The lead teacher noted “we had support meetings and talked a little bit.” She hoped that the project “was going to change a few things and give the children some new strategies and ways of dealing with things.” As for the teachers, in the lead teacher’s estimation “they probably have had to change, because they’ve had to use new equipment and do things in a different way.” In terms of on-going support after completion of the project in the school, the principal pointed out that the teachers “were getting courses.” He noted that “some of them are going to more than one course, depending on where they’re at.” The opportunity for teachers to attend further courses is a commitment taken at the expense of other curricular areas because, in the principal’s words, “teachers’ professional development in mathematics...is a target area for our school development.” However, enactment of the reform ideas required more than course attendance. As Cherie says: “What I’d really like to do is see what other teachers do in their classrooms and how they organise things and plan things. I mean even though we do go to one or two courses afterwards, it’s still not enough.”

## DIFFERENTIAL ENACTMENT

Both Cherie and Rowena claimed to be familiar with key reform themes and believed that their own skills and knowledge base had been enhanced. Both teachers expressed their support of those reform ideas and both claimed to be teaching mathematics in ways that approximated key aspects of the NDP’s recommendations. How might we account for the fact that Cherie undertook more extensive changes than Rowena in the core dimensions of practice? What might have contributed to Cherie’s more wholesale acceptance of new instructional practice?

A number of researchers (e.g., Cohen & Ball, 2001; Farmer, Gerretson, & Lassar, 2003) have argued that teachers’ prior practice, dispositions and beliefs all influence their ability to practice in ways recommended by reformers. To meet the reformers’ intentions, first and foremost our two case study teachers had to question how their current deep-rooted content and pedagogical knowledge measured up with the change proposals. Both claimed an understanding of the key concepts and both assessed those ideas against previous practice. Rowena talked in ways that resonated to a lesser degree than Cherie with the rhetoric of the key aspects of the numeracy reforms. We would suggest that Rowena’s understanding was located at the surface level and thus did not prompt her to make significant changes to her practice. Cherie, on the other hand, had a more substantive grasp of the key ideas and those ideas meshed to a certain extent with her own. She was able to signal how those concepts might be incorporated into the core dimensions of her practice.

It is in the personal arena of enactment where the teachers made mostly private sense of, and put into practice, their individualised ideas of the reform. But a teacher's effort to enact reforms is a distributed activity and has an important social dimension (McClain & Cobb, 2004). Another plausible explanation for the differential levels of engagement might lie in the support that they received at their respective schools. On the basis of that argument, the support at Cherie's school would surpass that available at Rowena's. The evidence from the interview data, however, does not lend support to this conjecture.

Collegial deliberations on practice that are grounded in everyday efforts to enact the reform ideas allow teachers to improve practice in specific ways. Yet the extensive support and ongoing deliberations with colleagues in Rowena's school failed to move her beyond a superficial level of practice. Conversations with peers that exemplified a 'norm of collaboration and deliberation' (Spillane, 1999) did not enable her to grasp what the reforms meant for the core dimensions of her teaching. In marked contrast, the 'norm of privacy' (Spillane) dominating classrooms at Cherie's school guaranteed that Cherie's enactment was highly individualistic. Her active agency, as well as her conceptual fit with the reform intentions, played a major part in her reform enactment. Accompanying that enactment, however, was a concern that the important ideas embodied within the Project were not being fully harnessed.

Arguably, both the external and personal sectors of teacher's zones of enactment are important in understanding teachers' learning about practice but, by themselves, neither is able to account for why individual teachers do or do not revise core practice. And while the initial professional development model offered to Rowena and Cherie was similar, the two teachers constructed distinctly different notions about practice from their engagement in the programme developed at the school.

## CONCLUSION

The two teachers expressed a willingness to reform their instruction in ways that they understood to be consistent with the numeracy project. There was no evidence to suggest that either of these teachers was resisting the reforms. Both teachers undertook changes to practices but demonstrated differential effects at meeting the intent of the reform. In this paper we have attempted to explain those differences by attending to the personal and external factors that influence teachers' practice.

Our explanations have taken an integrated approach to teachers' response to reform by looking at how personal resources and inclinations link with school-wide processes. We investigated those factors that relate to individual teachers themselves, to the community of teachers they work with, to their school community that, taken together, contribute to the 'take up' and continuance by teachers of those classroom practices. Our approach provided a point of departure from the body of literature that focuses solely on the role of professional development in supporting teachers' reorganisation of their instructional practices and their views of themselves as learners. The approach stands in contrast, too, to that body of literature that is concerned in the main with the structural or organisational systems within schools.

For us, it is the co-dependence of these two lines of inquiry that is more usefully able to account for the enactments of teachers' reform practice.

The intent of the reforms was enacted by these two teachers in quite unique ways and one could not argue that either the personal or the 'external' influences was more critical to reforming practice. On the basis of the data available to us, and our interpretation of that data, we suggest that one influence is not sufficient on its own to enable teachers to effect generative change. Perhaps more importantly the data has demonstrated that instituting collaborative work amongst teachers will not necessarily guarantee that teachers will work in ways consistent with reformers' intents. By focusing on the interface between the personal and the 'external' we can begin to understand why some teachers more than others engage more productively with reforms. It might also provide valuable insights about constructions of professional development.

## References

- Bobis, J. (2004). Time, resources, information overload and classroom management: Issues surrounding professional development. In A. Putt, R. Faragher, & M. McLean (Eds.), *Mathematics education for the third millennium towards 2010* (Proceedings of the 27<sup>th</sup> annual conference of the Mathematics Education Research Group of Australasia, pp. 103-110). Sydney: MERGA.
- Cohen, D., & Ball, D. (2001). Making change: Toward a theory of instruction and instructional improvement. *Kappan*, 83(1), 73-77.
- Falmer, J., Gerretson, H., & Lassak, M. (2003). What teachers take from professional development: Cases and implications. *Journal of Mathematics Teacher Education*, 6, 331-360.
- Higgins, J., Irwin, K. C., Thomas, G., Trinick, T., & Young-Loveridge, J. (2005). *Findings from the New Zealand Numeracy Development Project 2004*. Wellington: Learning Media.
- McClain, K., & Cobb, P. (2004). The critical role of institutional context in teacher development. *Proceedings of the 28<sup>th</sup> Conference of the International Group for the Psychology of Mathematics Education* (Vol. 3. pp. 281-288). Bergen: PME.
- Millett, A., Brown, M., Askew, M., & Johnson, D. (2004). (Eds.) *Primary mathematics and the developing professional*. Dordrecht: Kluwer.
- Ministry of Education. (2005). *The New Zealand Numeracy Development Project*. Wellington: Learning Media.
- Spillane, J. (1999). External reform initiatives and teachers' efforts to reconstruct their practice: the mediating role of teachers' zones of enactment. *Journal of Curriculum Studies*, 31(2), 143-175.



# AN INVESTIGATION OF FACTORS INFLUENCING TEACHERS' SCORING STUDENT RESPONSES TO MATHEMATICS CONSTRUCTED-RESPONSE ASSESSMENT TASKS

Ning Wang

Widener University

Jinfa Cai

University of Delaware

*This study identified some factors associated with teachers' knowledge and beliefs that have impacted scoring math constructed-response (CR) assessment tasks. Five groups of teachers who either had different teaching experiences or had different cultural beliefs about teaching and learning math were selected to score 28 students' responses to seven CR math tasks. Four factors were found to have significant impacts on the rating differences. They were teaching experience, experience with students at particular grade levels, the nature of students' responses, and beliefs in teaching and learning mathematics. The identification of the factors has implications both for promoting validity of test scores and for examining teachers' understanding of student learning targets.*

## PURPOSE OF THE STUDY

Analyzing and scoring students' written responses to constructed-response (CR) assessment tasks is a complex process. Numerous factors can affect the scoring of student responses to such an assessment task. To improve the objectivity for scores from such assessments—and eventually to ensure test score validity, ongoing efforts are being made in minimizing raters' effects on scoring those assessment tasks in the measurement community. An extensive literature focuses on training raters to address the concerns of rating consistency and objectivity (Fitzpatrick, et al, 1998; Mashburn & Henry, 2004; Moon & Hughes, 2002; Schafer, et al, 2001). However, little attention has been given to investigating what factors may have influenced analyzing and scoring students' responses to CR assessment tasks and in what ways such factors have influenced students' test scores. The purpose of this study is to identify some factors associated with teachers' knowledge and experience with students, as well as their beliefs about teaching and learning mathematics, that may have influenced their scoring student responses to CR assessment tasks in mathematics.

## THEORETICAL CONSIDERATIONS OF THE STUDY AND RESEARCH QUESTIONS

Using CR assessment tasks is based on a realization that assessments should have a profound influence on how students learn and on how teachers teach (Crooks, 1988; Madaus, 1988, Kane, et al, 1999). *Curriculum and Evaluation Standards for School Mathematics* developed by the National Council of Teachers of Mathematics (NCTM) (1989) heavily focuses on the development of students' mathematical proficiencies in problem-solving, communication of mathematical ideas, critical

reasoning, and connections to ideas and procedures both within mathematics and from other content areas. Such complex learning targets require the use of complex assessments, including CR assessment tasks, to actively engage students in the mastery of the complex skills (Arter, 1999). To fulfil the requirement for classroom assessment practice, it is necessary to know in what ways teachers think of student performance on the assessment tasks, how teachers score and analyze students' responses to the tasks, how teachers interpret the assessment results, and whether teachers' analyses and scoring align with the learning targets. Answers to these questions not only provide valuable information about effective instruction, but also provide evidence for validating test score interpretations.

Researchers claim that, in scoring and analyzing student responses to CR assessment tasks, teachers may differ in their judgment of the quality of a student's response (Klein, et al, 1998). Brookhart (1993) finds that teachers do not always follow recommended grading practices; instead, the constructs teachers use in grading are highly influenced by their value judgment. In investigating the impact of teachers' beliefs of mathematics on student learning, Cai (2004) indicates that teachers' beliefs are also reflected on their scoring of student responses. Klein and his colleagues (1998) examine how scoring rubrics would influence teachers' analyses of performance assessment tasks in science. The findings from Schafer et al. (2001) suggest that teacher knowledge of scoring rubrics increases the consistency of inter-rater agreements in scoring student responses to CR assessment tasks. Fitzpatrick, et al (1998) conclude that one of the factors that is likely to affect teachers' scoring consistency is the nature of the scoring rules that refers to qualities in students' responses. Observable qualities in a student's responses intended to obtain higher score consistency than abstract qualities being inferred from a student's response. On the other hand, even when teachers have extensive training in analyzing student responses using the same scoring criteria, the inter-rater agreement between two teachers is not as higher as we would like to have (Klein et al., 1998; Lane, et al, 1994). The situation could be worse in classroom assessments since teachers do not always have written scoring criteria available to guide their analysis of student responses. Instead, what they rely on are invisible criteria written in their mind, and these invisible criteria might be influenced by a number of factors.

Given the fact that teachers' analyzing and scoring student responses to CR assessment tasks have substantial impact on the improvement of student achievement and on the enhancement of student learning process, it is important to understand two things: what factors have influenced teachers' analyzing and scoring students' responses to CR assessment tasks and in what ways those factors have influenced students' test scores. In particular, this study is designed to answer the following research questions: 1) whether teachers' familiarity and experience with students and student learning of mathematics would affect their scoring? 2) whether teachers' beliefs in teaching and learning mathematics would affect their scoring? 3) whether the nature of students' responses would affect teachers' scoring?

## METHODS

### Research Design and Data Resource

To answer the 1<sup>st</sup> research question, teachers with different teaching experience (pre-service versus in-service teachers) as well as at different grade levels (elementary versus secondary teachers) were selected in this study. Cross-cultural studies revealed differences between U.S. and Chinese students' mathematical thinking and reasoning in their problem-solving process (Cai, 1995, 2000). Cai (2004) also found that the differences between the students in the two nations were likely due to teachers' differential beliefs in teaching and learning mathematics. As research indicates, teachers draw upon their cultural beliefs as a normative framework of values to guide their teaching (Bruner, 1996). To explore whether teachers' beliefs in teaching and learning mathematics would affect their scoring (the 2<sup>nd</sup> research question of the study), teachers from both the U.S. and China were selected to be in this study. As a result, five groups of teachers participated in the study. The first four groups of teachers were from a city in southwest China, including 53 pre-service elementary mathematics teachers (group 1), 60 pre-service secondary mathematics teachers (group 2), 59 in-service elementary school mathematics teachers of 4<sup>th</sup>, 5<sup>th</sup>, and 6<sup>th</sup> grade mathematics (group 3), and 50 in-service secondary school mathematics teachers (group 4). The fifth group of teachers included 52 in-service middle school mathematics teachers of 6<sup>th</sup>, 7<sup>th</sup>, and 8<sup>th</sup> grade mathematics from Delaware, North Carolina, Pennsylvania, and Wisconsin of the United States (group 5). The U.S. teachers (group 5) were chosen because they teach math contents similar to those of the Chinese in-service elementary school teachers (group 3). In total, 274 teachers participated in this study.

The average number of years of teaching experience was 21 years for the teachers in group 3, 17 years for the teachers in group 4, and 19 years for the teachers in group 5. The two groups of pre-service teachers (groups 1 and 2) were in their senior year of college when the data were collected.

To examine whether the nature of students' responses would affect teachers' scoring (the 3<sup>rd</sup> research question of the study), a set of 28 student responses to seven CR assessment tasks in mathematics were selected. The CR assessment tasks used in this study were developed by various research projects (Cai, 2000; Lane, 1993). Detailed descriptions of the CR tasks and the 28 student responses can be found in Cai (2000). These tasks were embedded in various content areas, covered in the Chinese 4<sup>th</sup>, 5<sup>th</sup>, and 6<sup>th</sup> grade math curriculum and in the U.S. 6<sup>th</sup>, 7<sup>th</sup>, and 8<sup>th</sup> grade math curriculum. This was the reason that Chinese elementary math teachers (teaching 4<sup>th</sup>, 5<sup>th</sup>, and 6<sup>th</sup> grade math) and U.S. middle school math teachers (teaching 6<sup>th</sup>, 7<sup>th</sup>, and 8<sup>th</sup> grade math) were selected for the study. Each of these student responses had a correct answer (or a reasonable estimate for the answer) and an appropriate strategy that yielded the correct answer (or estimate), but representations and solution strategies in these responses were different.

## Data Collection

Data collection consisted two phases: in the first phase, each of the 274 teachers was asked to score the 28 student responses using a general 5-point scoring rubric (0-4):

- 4 points - correct and complete understanding;
- 3 points - correct and complete, except for a minor error, omission, or ambiguity;
- 2 points - partial understanding of the problem or related concept;
- 1 point - a limited understanding of the problem or related concept;
- 0 points - no understanding of the problem or related concept.

After they completed their scoring, in the second phase, 9 Chinese in-service elementary teachers from group 3, and 11 U.S. in-service middle school teachers from group 5 were selected. Each of these teachers was interviewed and asked to explain the reasons for his/her scoring of each of the 28 responses. All interviews were videotaped and transcribed. In both data collection phases, teachers were informed that the responses were from 6<sup>th</sup> grade students.

## RESULTS AND DISCUSSIONS

### Results from Four Groups of Chinese Teachers (Groups 1, 2, 3, and 4)

Table 1 provides the overall mean ratings across the 28 responses for the four groups of Chinese teachers. The analysis of variance across the four groups of teachers shows that there is a significant difference in their overall mean ratings across the 28 responses [ $F(3, 218) = 7.091, p < .001$ ]. A post hoc comparison indicates that significant differences exist between the following pairs of the groups:

In-service elementary	vs.	Pre-service elementary ( $p = .007$ )
In-service elementary	vs.	Pre-service secondary ( $p < .001$ )
In-service elementary	vs.	In-service secondary ( $p = .008$ )

This result reveals a contrast between the teachers who have the same cultural beliefs in teaching and learning mathematics but with different levels of familiarity and knowledge about students and student learning of mathematics. For the in-service teachers, one group teaches students at the level being assessed in this study (group 3) and the other group teaches at a different level (group 4).

It is interesting to find that all of the significant differences exist between the in-service elementary teachers (i.e., the targeted assessment level in this study) and each of the other three groups. There is no significant difference in the mean ratings between any pairs of the other three groups of teachers. Also, in-service elementary teachers rate students' responses more leniently and provide higher scores than the remaining three groups of teachers do. Because the CR assessment tasks used in this study and the students' responses selected for scoring are within the in-service elementary teachers' teaching level, this result clearly indicates that teachers' familiarity and their knowledge about students' understanding and ability has an influence on their scoring of students' responses to CR math assessment tasks. This result indicates that raters' experience with students and student learning of mathematics is one factor that influences the scoring of the open-ended tasks.

The influence of this factor can be found on the individual responses as well. Not only do the significant differences exist on the overall mean ratings of the 28 responses between the groups of teachers, but also similar differences are found on many individual responses. Statistical tests indicate that 12 out of the 28 responses show significant differences in the mean ratings among the four groups of teachers, while the in-service elementary teachers have significantly higher ratings than do at least one of the other three groups on 11 of the responses.

Overall, in-service elementary teachers rate significantly higher than in-service secondary teachers, but no significant difference exists between the in-service secondary teachers and any other groups of the pre-service teachers. The in-service secondary teachers provide ratings similar to both pre-service elementary and secondary teachers. At the individual response level, the in-service secondary teachers provide mean ratings similar to both pre-service elementary and secondary teachers on 22 of the 28 responses. This result suggests that teaching experience alone does not necessarily distinguish raters from others in scoring students' responses. Although in-service secondary math teachers have extensive teaching experience, such experience does not guarantee their familiarity with and knowledge about teaching and learning mathematics for the grade level of the students being assessed. This result indicates that not only raters' experience with students, but also raters' experience at different grade levels can be factors that influence the scoring of the CR assessment tasks.

### **Results from Two Groups of In-Service Teachers (Groups 3 and 5)**

The statistical analysis shows that the overall mean ratings across the 28 responses for the teacher group 5 (in-service U.S. middle school teachers, Mean = 3.336) is significantly higher than that for the teacher groups 3 (in-service Chinese elementary teachers, Mean = 3.052) [ $F(1, 109) = 12.177, p = .001$ ]. Analysis for each individual response indicates that significant differences exist between the two groups of teachers' ratings for 8 out of the 28 responses at the significant level at or lower than 0.001. In addition, one response shows difference at the significant level of .005 and one response shows difference at the level of 0.01.

An examination of the differences based on each of the 28 individual responses indicates that the nature of the student responses has influenced the teachers' scoring. Table 2 summarizes the averaged ratings for four types of students' responses that show significant differences between the two groups of teachers. These types are 8 responses that involve visual drawings or concrete solution strategies [ $F(1, 109) = 34.608, p < .001$ ], Response 15 that consists of mathematics errors [ $F(1, 109) = 41.767, p < .001$ ], Response 18 that uses guess-and-check solution strategy [ $F(1, 109) = 11.879, p = .001$ ], and Response 27 that allows for multiple correct answers [ $F(1, 109) = 6.591, p = .012$ ]. Among all of the 28 responses, Response 15 counts for the largest difference in the ratings between the two groups of teachers. For Response 27, the U.S. teachers provide the lowest ratings on average and the difference between the two groups of teachers is on the borderline of being statistically significant. Also, the U.S. teachers have the highest variation in scoring this response as compared to

the Chinese teachers and their ratings on the other responses. For the other three types of responses, the U.S. teachers provide significantly higher ratings than Chinese teachers.

The analysis from the interview data indicates that not only have the nature of students' solution strategies impacted teachers' ratings, but also the differences in teachers' beliefs in teaching and learning mathematics have affected teachers' scoring of students' responses. It is found that the Chinese teachers consistently take the nature of the solution strategies into account in their scoring. If a response involves a drawing or making a list, Chinese teachers usually give a relatively lower score even though the strategy is appropriate with the correct answer. The general reason Chinese teachers give for their lower scores to the responses with visual or concrete approaches is that the strategy does not find regularities. Although most U.S. teachers realize that drawing is not a sophisticated—but a very time-consuming—strategy, they also comment that the drawing in some cases is a viable approach producing a correct answer. Moreover, almost all the U.S. teachers state that these visual strategies clearly show how students think and solve the problems, whereas Chinese teachers seem to have a clear goal: students should learn more generalized strategies.

The errors in Response 15 are related to the written communication of students' thinking. The process reflects the chain of thoughts that a student used to solve the problem. Although the result is correct, the mathematical expression consists of errors. Interviews with the teachers reveal that Chinese teachers tend to be more stringent in scoring students' responses like this, and they do expect students' written expression to be mathematically appropriate. They believe that the use of appropriate expressions in mathematics can help students develop their mathematical proficiencies and logical thinking. Meanwhile, this type of error does not have as much impact on U.S. teachers' ratings. They tend to be more tolerant and allow students to write what they think without paying much attention to students' written expression.

## SUMMARY

In order to enhance the validity and objectivity of test scores obtained from assessments that consists of CR tasks, minimizing rater effects has been a particular concern. However, there has been limited research to identify possible factors that influence ratings of students' responses in such assessment tasks. This study identifies some factors associated with teachers' knowledge and beliefs that have impacted scoring math CR assessment tasks. Five groups of teachers who either have different teaching experiences or have different cultural beliefs about teaching and learning mathematics are selected to score students' responses to a number of CR math tasks. Four factors are found to have significant impacts on the rating differences. They are teaching experience, experience with students at particular grade levels, the nature of students' responses, and beliefs in teaching and learning mathematics. The identification of the factors not only provide suggestions to the field of performance assessment in minimizing rater effects, assisting in rater

training, and promoting scoring objectivity as well as validity of test scores, but it also helps to examine teachers' understanding of student learning targets, and further promotes effective instruction.

## References

- Arter, J. (1999). Teaching measures of performance. *Educational Measurement: Issues and Practice*, 18(2), 30-44.
- Bruner, J. (1996). *The Culture of Education*. Cambridge, MA: Harvard University Press.
- Cai, J. (1995). *A cognitive analysis of U.S. and Chinese students' mathematical performance on tasks involving computation, simple problem solving, and complex problem solving*. (Journal for Research in Mathematics Education monograph series 7), Reston, VA: National Council of Teachers of Mathematics.
- Cai, J. (2000). Mathematical thinking involved in U.S. and Chinese students' solving process-constrained and process-open problems. *Mathematical Thinking and Learning*, 2, 309-340.
- Cai, J. (2004). Who do U.S. and Chinese students think differently in mathematical problem solving? Impact of early algebra learning and teachers' beliefs. *Journal of Mathematical Behavior*, 23(1), 135-167.
- Crooks, T. J. (1988). The impact of classroom evaluation practices on students. *Review of Educational Research*, 58, 438-481.
- Fitzpatrick, A., Ercikan, K., Yen, W., & Ferrara, S. (1998). The consistency between raters scoring in different test years. *Applied Measurement in Education*, 11(2), 195-208.
- Kane, M., Crooks, T., & Cohen, A. (1999). Validating measures of performance. *Educational Measurement: Issues and Practice*, 18(2), 5-17.
- Klein, S. P., Stecher, B. M., Shavelson, R. J., McCaffrey, D., Ormseth, T., Bell, R. M., Comfort, K., & Othman, A. R. (1998). Analytic versus holistic scoring of science performance tasks. *Applied Measurement in Education*, 11, 121-137.
- Lane, S. (1993). The conceptual framework for the development of a mathematics assessment instrument for QUASAR. *Educational Measurement: Issues and Practice*, 12(2), 16-23.
- Lane, S., Stone, C. A., Ankenmann, R. D., & Liu, M. (1994). Reliability and validity of a mathematics performance assessment. *International Journal of Educational Research*, 21(3), 247-266.
- Madaus, G. F. (1988). The influences of testing on the curriculum. In L. N. Tarner (Ed.), *Critical Issues in Curriculum* (pp. 83-121). Eight-Seven Yearbook of the National Society for the Study of Education, Part I. Chicago: University of Chicago Press.
- Moon, T. & Hughes, K. (2002). Training and scoring issues involved in large-scale writing assessments. *Educational Measurement: Issues and Practice*, 21(2), 15-19.
- National Council of Teachers of Mathematics (1989). *Curriculum and Evaluation Standards for School Mathematics*. Reston, VA: National Council of Teachers of Mathematics.
- Schafer, W. D., Swanson, G., Bene, N., & Newberry, G. (2001). Effects of teacher knowledge of rubrics on student achievement in four content areas. *Applied Measurement in Education*, 14(2) 151-170.

Table 1: Mean Ratings and Associated Standard Deviations across the 28 Responses by Four Groups of Chinese Teachers

Group	# of Teachers	Mean	Std. Deviation
Pre-service elementary	53	2.796	.350
Pre-service secondary	60	2.731	.325
In-service elementary	59	3.052	.519
In-service secondary	50	2.796	.407

Table 2: Mean Ratings for 4 Types of Student Responses from Teacher Groups 3 &amp; 5

Response Type	Responses	Mean Ratings for Chinese In-Service Elementary Teachers (n=59)*	Mean Ratings for U.S. In-Service Middle School Teachers (n=52)
Responses Involving Visual Drawings or Concrete Solution Strategies	2, 4, 5, 13, 14, 17, 21, & 26	2.913 (0.763)	3.577 (0.301)
Responses Involving Mathematics Errors	15	2.39 (1.260)	3.62 (0.565)
Responses Using Guess-and-Check Solution Strategy	18	3.10 (1.109)	3.69 (0.579)
Responses Involving Multiple Correct Answers	27	2.97 (1.414)	2.23 (1.604)

\*A number in parentheses indicates the standard deviation associated with each mean.



# TEACHER ACTIONS THAT ASSIST YOUNG STUDENTS WRITE GENERALIZATIONS IN WORDS AND IN SYMBOLS

Elizabeth Warren

Australian Catholic University

*Past research has indicated that there is evidence of a relationship between adolescent students' ability to express generalisations as written descriptions and in symbolic forms. This research investigates whether this relationship occurs with younger students and identifies teacher actions that begin to assist the development of this relationship. A teaching experiment was conducted with twenty seven students with an average age of 10 years. From the results it appears that after a short intervention period, one fifth of these students could express generalizations in both written and symbolic form. It also indicated that particular teacher actions assisted students to identify the generalization and to express it both as a rule and as an equation.*

Generalising as an algebraic activity has long been widely accepted as an important approach to introducing algebraic concepts to young adolescents (12-13 year olds) (e.g., Mason, Pimms, Graham, & Gower, 1985). Such approaches build on the explorations of visual growing patterns, using the patterns to generate algebraic expressions. One purpose for setting pattern tasks within pictorial and practical contexts is to endeavour to provide an alternative format to lists of numbers (Orton, Orton & Roper, 1999). A patterning approach to algebra allows students to experience unknowns as variables, and provides students with opportunities to observe, verbalise and symbolize generalizations (English & Warren, 1998). For the purpose of this research we define growing patterns as having a discernable unit that grows by a constant amount and thus the position (step) in the pattern depends upon the previous position and the numerical value of its position.

Young students are capable of articulating the generality of the growing pattern in terms of its position in the pattern (Warren, 2005) and teacher actions that assisted the development of this capability were conjectured to be (a) the use of concrete materials, (b) patterns where the relationship between the pattern and position were explicit, and (c) explicit questioning that linked the position to the pattern. This paper builds on the research reported in Warren (2005) by examining teacher actions that assist elementary students to begin to express their written description in symbols, especially in abstract symbol systems including the use of notation systems for the unknown.

Approaches used to find the general rule, that is, defining the growing pattern in relation to its position in the pattern appear to fall into three broad categories (Redden, 1996). These are, (a) using one example to predict the relationship between uncountable examples (e.g., if the 5<sup>th</sup> step has 11 tiles then the 10<sup>th</sup> step would have 22 tiles), (b) the additive strategy where connections among consecutive elements

(e.g., for each step you add 2 tiles), and (c) functional strategy where a relationship is formed between the two data sets (e.g., the number of tiles is the step number multiplied by 2 add 1). These strategies tend to be hierarchical (Redden, 1996; Stacey, 1989; Warren, 1996). Once students perceive a pattern in a certain way, it is difficult for them to abandon their initial perception (English & Warren, 1998; Lee, 1996).

While past research has reported a tension between natural language and the impossibility of using it for the construction of symbolic representations, little research has occurred focusing on teacher actions that assist in making these links. For example, the results of Redden's (1996) longitudinal study with 26 students (aged 13) indicated that on the whole, it appeared that using natural language to describe the generality of number patterns is a necessary prerequisite for the emergence of algebraic notation. Stacey and Macgregor (1995) conjectured that correct verbal descriptions are more likely to lead to correct algebraic rules and students who could find the correct functional relationship could usually articulate this relationship verbally. Both studies simply administered tests to large groups of adolescent students and analyzed the results to identify relationships. They did not attempt to ascertain what particular actions assist in establishing these important links. The research reported in this paper takes this discussion to the next level, determining whether elementary students can effectively engage in these conversations and identifying teacher actions that assist in establishing the links between verbal and symbolic descriptions of generalizations. The specific aims of the study were to (a) identify the relationship between writing a generalization in words and in symbols, and (b) determine particular teacher actions that assist in forging this relationship.

## METHOD

Four lessons were conducted in one Year 5 classroom from a middle socio-economic elementary schools from an inner suburb of a major city. The sample comprised 27 students (average age of 10 years), the classroom teacher and 2 researchers. The actions from the four lessons reported in this paper were those conducted by one of the researchers (teacher/researcher). The lessons were of approximately one hour's duration and exploratory in nature. The tasks chosen were context free. This decision was based on the concern that while context related tasks, such as the different arrangements of tables and chairs, may be seen as purposeful, there is a danger that the context itself may inhibit negotiation of the boundary between the mathematical and the real (Bills, Ainley & Wilson, 2003). The lessons consisted of five main dimensions (a) using concrete materials to represent various growing patterns (b) translating the pattern into a table to further draw out the functional relationship inherent in the pattern (c) developing specific language to support the development of the concept of the relationship between pattern position and number of tiles (d) sharing different ways of describing the generalizations in everyday language and symbols, and (e) encouraging students to justify their generalizations. The patterns chosen were linear and the representations were arranged so that the links between the visual, position and pattern rule were explicit. The generalization for each lesson

were: Lesson 1  $2n+1$ , Lesson 2  $2n+2$  and  $2n+1$ , Lesson 3  $2n+1$  and  $3n+1$ , and Lesson 4  $3n+1$ ,  $2n-1$  and  $2n+2$ .

### Data gathering techniques and procedures.

The methodology adopted for the Teaching Experiments was the conjecture driven approach of Confrey and Lachance (2000). The conjecture consists of two dimensions, mathematical content and pedagogy linked to the content. The design aimed to produce both theoretical analyses and instructional innovations (Cobb, Yackel, & McClain 2000). During and in between each lesson hypotheses were conceived 'on the fly' and were responsive to the teacher-researcher and the students. During the teaching phases, the researcher and classroom teacher acted as participant observers, recording field notes of significant events. All lessons were videotaped using two video cameras, one on the teacher and one on the students, focusing on the students that actively participated in the discussion. The video-tapes were transcribed and worksheets collected.

At the beginning of the first lesson students were asked to complete a simple activity involving constructing growing patterns with tiles, continuing this pattern, giving a verbal description of the pattern and expressing this generalization in algebraic notation. Following reflection with the other researcher and teacher, field notes and the evidence of students' worksheets it appeared that these students had had little experience with growing patterns and exhibited difficulties in describing these patterns in everyday language let alone using symbolic notation systems.

At the completion of the teaching phase a test comprising of three questions was administered. The questions reflected the types of activities that occurred within the lessons. Figure 1 summarises the three patterns that formed the basis for the Questions.

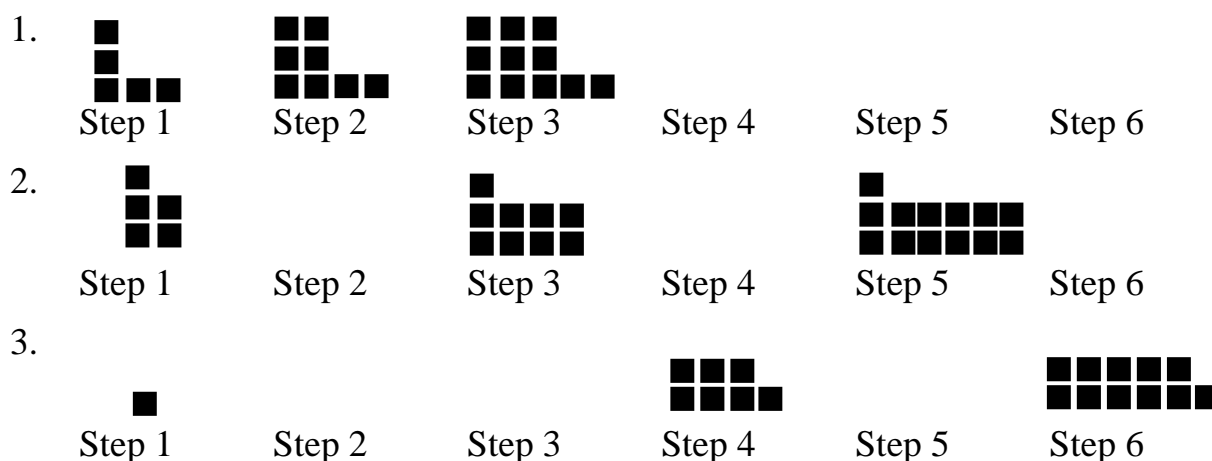

Figure 1 The patterns presented in the post test.

In each instance students were instructed to complete the pattern, write the position rule for the pattern and write the rule using symbols. The questions mirrored the types of activities that occurred during the teaching phase.

## RESULTS

The responses to Question 1, 2 and 3 for the sections relating to writing the general rule and expressing the rule in symbols were categorized. The responses to each component fell into 5 broad categories ranging from descriptions that gave no indication of the relationship between the pattern and its position to responses that specifically related the pattern to its position. The next section describes each category for the written responses with a typical response for each.

Category 1. No response.

Category 2. Nonsense response. (*The patterns keep on growing and growing*)

Category 3. Quantifying the growth rule. (*Goes up by two. One more on each end*)

Category 4. Relationship between position and pattern. (*Each step number  $\times 2 =$  number of tiles or It's double the number of the step*)

Category 5. Relating between pattern and position with visual. (*The top and bottom row of the stars is the same number as the step*)

Both descriptions for Category 4 and 5 were considered to be correct.

Table 1 summarises the frequency of responses for each level for Q1, Q2 and Q3.

Table 1 Frequency of responses to: Write the position rule for this pattern

Category	Q 1.	Q 2.	Q 3.
1 No response	1	3	0
2. Nonsense response (it grows or doesn't make sense)	5	7	7
3. Quantify the growing rule (e.g., grows by 3)	11	11	13
4. Relationship between position and pattern	6	5	5
5. Relationship between position and pattern with visual	4	1	2

Thirty seven percent of the sample successfully wrote the position rule for the pattern for at least one of the questions (Question 1 – 37%, Question 2 – 22%, Question 3 – 26%).

Categories for symbolic descriptions

Category 1. No response.

Category 2. Nonsense response.

Category 3. Quantifying the growing rule in symbols. (+3)

Category 4 Quantified specific example. ( $2 \times 3 + 2$ ;  $3 \times 3 + 2$ )

Category 5 Correct symbolic relationship using unknowns. ( $3 \times \boxed{?} + 2$ )

Table 2. Frequency of responses to: Write your rule in symbols for questions 1, 2 and 3

Category	Q 1.	Q 2.	Q 3.
1. No response	2	5	5
2. Nonsense response	6	6	6
3. Quantify the growing rule in symbols (e.g., +3)	13	12	11
4. Quantified specific example	1	0	2
5. Correct symbolic relationship with unknowns	5	4	3

Nineteen percent of the sample could successfully write their rule in a symbolic form (Question 1 – 19%, Question 2 – 15%, Question 3 – 11%). In order to ascertain the relationship between students' verbal description and symbolic descriptions of the pattern presented in Questions 1, 2 and 3, a Wilcoxon Signed Ranked test was performed.

Table 3 Results of the Wilcoxon Signed Rank test

	Question 1	Question 2	Question 3
Z score	-.996	-.436	-1.706
Significance	.319	.663	.088

As evidenced by the results of the Wilcoxon Signed Ranked test, there was no significant difference between the level of response each student proffered for the written description and the symbolic description of the generalization for each of the three Questions. The next section briefly summarises the particular teacher actions that are believed to assist students to (a) give verbal descriptions of the generalizations and (b) use these descriptions to support the development of the correct notation system.

### Teaching actions

*Using language and actions to relate the visual representation to the table of values.*

Past research has shown that there is a propensity for students to use (a) one example to predict the relationship between uncountable examples, and (b) the additive strategy by connecting consecutive elements. Thus specific teaching strategies and language were developed to not only encourage students to examine functional relationship in the pattern but also to transfer this understanding to the table of values. As students proffered their generalizations each was classified as a Growing rule or a Position rule.

This classification system was also used to explicitly map the two ways of examining the visual pattern (i.e., looking along the visual pattern and linking the pattern to its position) and the two ways of examining the table (i.e., looking down one column and looking across the two columns). The following extract exemplifies the types of classroom conversations that ensued during the four lessons:

Warren

TR: What is a position pattern?

Cath: A position pattern is where the step number has something to do with the pattern.

TR: Yes, the step number and the pattern. So you are looking across the table that is where the pattern is.

TR: I want you to think how you go from step 2 to get 6, from step 3 to get 8 (drawing arrows across the table linking the two columns and writing position rule)

And in another excerpt when referring to the visual pattern:-

TR: How would you describe this pattern?

John: You just keep adding on 2.

TR: Is that a growing rule or a position rule? Is it telling me how the pattern is growing? (drawing an arrow along the pattern and writing growing rule)

Sally: Yes. It is telling us how it is growing.

*Introducing specific language to assist in describing the visual pattern.*

Specific language was introduced to assist students to describe the pattern in general terms. We conjectured that language may be another barrier to identifying co-variational thinking. It was evident that in all instances it was simpler to say “the pattern is growing by two tiles” than to say, “both rows always have the same number of tiles as the position number”. Hence language such as rows, columns, double and multiply was introduced throughout the lesson sequence. By the completion of the four lessons many students were still experiencing difficulties in expressing generalizations in language, however analysis of the videos indicated a marked improvement in the manner in which they described their generalizations.

TR: Tell me what the 4<sup>th</sup> step looks like

Mary: Four greens and five reds.

TR: How do you know that?

Mary: The green row is always one more than the step and the red one below is one more than the green.

TR: If I have step 10, how many tiles would there be?

Tom: 22

TR: How did you work it out?

Cath: Whatever the number is you double that number and add 2.

Justifying their verbal descriptions:

Explicit justification of their descriptions appeared to assist students refine their descriptions.

Nick: What I did is, plus 1 to the step number then times it by two.

TR: So would it work, lets see. So for 5 what would I do? (Pointing to the step on the board)

Nick: Plus 1 equals 6 times 2, equals 12 .

TR: Who has a different one?

Jill: Times the step by 2 add 4 and take 2.

The conversation then focused on Jill justifying her description and ascertaining if it worked for a wide variety of step numbers.

Explicitly translating verbal descriptions into symbolic notation systems:-

As students gave their verbal descriptions they were asked to express it in symbolic form. These conversations were ongoing throughout the four lessons. The following excerpt represents a typical conversation that occurred.

- Amy: Well the step number is 1 and you add 4 and the 2<sup>nd</sup> step you add 4 to it.  
 TR: Can you give it to me in general terms?  
 Amy: You add 4 on every step number. Oh, I don't know.  
 TR: Can someone write it as a mathematical sentence using unknown?  
 Sue: Unknown plus 4 equals unknown.  
 TR: How do we write this? (Sue writes  $? + 4 = ?$  on the blackboard)

Introducing specific symbols for unknown amounts and relating this to large numbers:-

- TR: If we want to talk about any step how do we describe this?  
 Carol: We call it the n step where n is any number you want it to be.  
 TR: How many green tiles would there be?  
 Carol: Depends on which number it is. Could be two billionth step. There would be Two billion reds and one left over and there would be two billion greens.  
 TR: Excellent. Does anyone have another description?  
 Tom: The n step is anyone with one left over.  
 Henry: There are n green ones and n plus one red ones.

## DISCUSSION AND CONCLUSIONS

This research commences to not only identify teacher actions that support examining growing patterns as functional relationships between the pattern and its position, but also delineate thinking that impacts on this process. Many of the difficulties these children experienced mirror the difficulties found in past research with young adolescents. This suggests that perhaps these difficulties are not so much developmental but experiential, as these early classroom experiences began to bridge many of these gaps.

The results from Table 1 and Table 2 indicated that after the four lessons thirty seven percent of the students could successfully write a rule relating the pattern elements to their position and nineteen percent could successfully write the rule using symbols. These results are comparable with the results from studies conducted with young adolescent students (e.g., Warren, 1996). Our conjecture is that algebraic activity can occur at an earlier age than we had ever thought possible and that these experiences with appropriate teacher actions may assist more students join the conversation in their adolescent years. Presently in many instances the transition from arithmetic to algebra appears too abrupt, with many young adolescents quickly moving from arithmetic to the introduction of the concept of a variable to symbolic manipulation

Warren

(e.g., Bills, Ainley and Wilson, 2003). The impact these early conversations has on the transition to formal algebraic experiences requires further investigation.

## References

- Bills, E., Ainley, J. & Wilson, K. (2003). Particular and general in early symbolic manipulation. *Proceedings of the 2003 joint meeting of the Psychology of Mathematics Education and Psychology of Mathematics Education North America*, 2, 105-112, Honolulu, Hawaii.
- Cobb, P., Yackel, E., & McClain, K. (Eds.) (2000). *Symbolising and communicating in mathematics classrooms. Perspectives on discourse, tools and instructional design*. Mahwah, NJ: Lawrence Erlbaum.
- Confrey, J., & Lachance, A. (2000). Transformative teaching experiments through conjecture-driven research design. In A. E. Kelly & R. A. Lesh (Eds.), *Handbook of research design in mathematics and science education* (pp. 231-265). Mahwah, NJ: Lawrence Erlbaum.
- English, L. D. & Warren, E. (1998). Introducing the variable through pattern exploration. *The Mathematics Teacher*, 91(2), 166-171.
- Lee, L. (1996). An initiation into algebraic culture through generalization activities. In N. Bednarz, C. Kieran, & L. Lee. (Eds.), *Approaches to algebra* (pp. 87-106). Dordrecht: Kluwer Academic.
- Mason, J., Pimm, D., Graham, A. and Gower, N. (1985). *Routes to/Roots of Algebra*. Milton Keynes: Open University.
- Orton, J., Orton, A., & Roper, T. (1999). Pictorial and practical contexts and the perception of pattern. In A. Orton (Ed.), *Patterns in the teaching and learning of mathematics*. London: Cassell.
- Redden, T. (1996). "Wouldn't it be good if we had a symbol to stand for any number". In L. Puig & A. Gutierrez (Eds.), *Proceedings of the 20th International Conference for Psychology of Mathematics Education* (Vol. 4, pp. 195-202). Valencia, Spain: Program Committee for PME 20.
- Stacey, K. (1989). Finding and Using Patterns in Linear Generalising Problems. *Educational Studies in Mathematics*. 20(2), 147-164
- Stacey, K., & MacGregor, M. (1995). The effects of different approaches to algebra in students' perception of functional relationships. *Mathematics Education Research Journal*, 20, 147-164.
- Warren, E. (1996). *Interaction between instructional approaches, students' reasoning processes, and their understanding of elementary algebra*. Unpublished dissertation. Queensland University of Technology.
- Warren, E. (2005). Young children's ability to generalize the pattern rule for growing patterns. . In H. Chick & J. Vincent (Eds.) *Proceedings of the 29<sup>th</sup> conference of the International Group for the Psychology of Mathematics Education*, 4, 305-312. Melbourne: University of Melbourne.



# PROMOTING PRE-SERVICE TEACHERS' UNDERSTANDING OF DECIMAL NOTATION AND ITS TEACHING

Wanty Widjaja and Kaye Stacey

Sanata Dharma University, Indonesia and University of Melbourne, Australia

*This paper discusses the results of the first cycle of a design experiment aimed at improving Indonesian pre-service teachers' understanding of decimal notation and at having them participate in a new pedagogy that they can use in future teaching. Classroom observations, written responses to learning activities along with pre-test and post-test data will be discussed to describe how their understanding evolved. Findings suggest substantial improvement in being able to decompose a decimal number into place-value related parts. However the results also showed that many pre-service teachers did not grasp base ten structures in decomposing decimals and the models have not been used as a thinking tool. The next cycle of the design experiment will address these issues.*

## INTRODUCTION

Studies investigating pre-service teachers understanding of decimal numeration reveal that misconceptions persist in this group (Putt, 1995; Stacey, Helme, Steinle et al., 2001). Weak understandings of place value coupled by weak notions of the magnitude of decimals are amongst the indicators of problems in decimal numeration. Putt (1995) in his investigation of pre-service teachers' knowledge in ordering decimals found problems in understanding equivalent decimals such as 0.7, 0.70, and 0.700. He also noted that some pre-service teachers' interpretation of a decimal number is limited to a single representation. The fact that pre-service teachers in their future employment may share their misconceptions with children underscores the need to improve pre-service teachers' understanding in decimals.

An analysis of some Indonesian commercial textbooks (e.g., Listyastuti & Aji, 2002a, 2002b) indicates reliance on extensive use of syntactic rules based on whole numbers to teach decimals. The approach to teaching and learning decimals is very symbolic and no attention is given to creating meaningful referents such as concrete models to help students make sense of the place value structure of decimal notation. The models for learning decimals presented in the textbooks are the more symbolic models such as number lines, emphasising positions of points rather than lengths of lines. Research in Western countries has shown that this approach does not develop well-connected understanding of decimals. Hiebert (1992) argued that "A greater investment of time would be required to develop meaning for the symbols at the outset and less emphasis would be placed on immediate computational proficiency" (p. 318). Furthermore he contends that having meaningful interpretation of decimal notation will enhance performance in computation skills. Current thinking in Indonesia, influenced by the Freudenthal realistic mathematics education, accepts

that improvement in mathematics education will come by increasing emphasis on developing meaning and moving away from teaching based only on rules, and through adopting new teaching methodologies, such as group work, which encourage students to construct mathematical ideas together.

Despite extensive studies of decimals in other countries (Irwin, 1995; Peled & Shabari, 2003; Steinle & Stacey, 2003), a study of teaching and learning decimals in the Indonesian context has not been carried out. Considering the above approach to learning decimals, it is posited that Indonesian pre-service teachers' knowledge in decimals will be limited and not well-connected. Hence, this study intends to develop a set of appropriate learning activities on decimals to promote a conceptual understanding of the topic for pre-service teachers in Indonesia and to strengthen their ideas about how to teach the topic. The study follows a design research methodology adhering to Gravemeijer's account (2004), whereby a set of instructional activities for a specific topic is devised through a cycle of design, teaching experiment and retrospective analysis. The starting point for devising the instructional activities is taken from the existing knowledge of the students and by hypothesizing their learning trajectories.

The small section of the study that is reported in this paper is from the first design cycle and examines one set of activities designed to explore meaningful interpretation of decimals in terms of place value. Stacey (2005) contends that full understanding of the meaning of decimal notation includes the ability of interpreting a decimal number in terms of place value in several ways based on additive and multiplicative structure of decimals. Realizing the importance and the challenge of introducing the use of concrete materials in learning decimals into Indonesia, this study uses concrete models to assist pre-service teachers improve their understanding of decimals and to provide them with ideas for teaching decimals to children.

## **METHODOLOGY**

### **Participants and Procedure**

Two groups of pre-service teachers, i.e. pre-service primary and pre-service secondary attending Sanata Dharma University in Yogyakarta, Indonesia participated in this study. The pre-service primary teachers undertake a two-year diploma program run by elementary teacher training department, whereas the pre-service secondary teachers enrol in a 4-year bachelor of education program run by mathematics and science education department. It should be noted that the nature of their participation and teaching intervention for both groups were the same. Two lecturers carried out the whole activities within 5-6 meetings of 100 minutes each, during August-October 2005. The researcher took an observer role, and directed the video-taping. One lecturer taught both pre-service primary and pre-service secondary cohorts while the other only taught one of the pre-service primary cohorts.

The 3 activities discussed in this paper were carried out in 2 meetings, where the pre-service teachers worked on the activities in groups (4 - 6 pre-service teachers in each

group). A total of 30 groups were involved in these activities, 11 from pre-service secondary cohort and 19 from pre-service primary cohort. Two groups of pre-service secondary and 3 groups of pre-service primary teachers were videotaped during these sessions. The selection of groups to be videotaped was based on their consent to be videorecorded and their communicative skills in expressing of their thinking.

The meetings involved very limited number of lecturing, which was a clear departure from normal practice for both lecturers and students. Pre-service teachers work in groups discussing and finding solutions for the tasks together. The lecturers' role in this study is more as a facilitator for delivering activities and leading group presentations and discussions. The rationale for choosing this mode of delivering the activities is to encourage active participation of pre-service teachers in constructing meanings for themselves. It is expected that they will be able to explore more ideas this way, and get firsthand experience of new methodologies for their future career.

In these meetings, two concrete models were used: a concrete model called Linear Arithmetic Blocks (LAB) (See Figure 1 below), and a number expander. These two models are both new for participants in this study. These models have been explored in prior studies on teaching and learning decimals (Stacey, Helme, Archer, & Condon, 2001; Steinle, Stacey, & Chambers, 2002) and suggested as powerful models in learning decimals. LAB represents decimal numbers by the quantity of length (not metric length such as metres and centimetres). It consists of long pipes that represent a unit and shorter pieces that represent tenths, hundredths, and thousandths in proportion. Pieces can be placed together to create a length modelling a decimal number and can be grouped or decomposed (for example to show 0.23 as 2 tenths + 3 hundredths or as 23 hundredths). A number expander, although a concrete model, works on the symbolic representation. It displays the extended notation of a number in different ways as can be seen in Figure 2 below. The use of two models in these learning activities, one with a physical representation and the other using the symbolic representation of number, appeared to be consistent with the goal of constructing meaningful understanding of decimal notation in terms of place value.

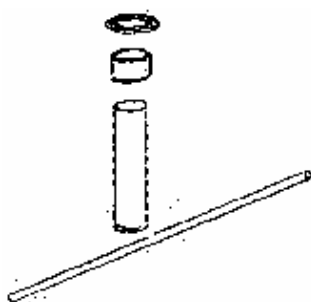

Figure 1: LAB pieces



Figure 2: Various expansions of 3.145

As part of the design research, pre-service teachers took written tests and some of them participated in individual interviews, which were conducted before and after the teacher intervention. Prior to the teaching intervention, 136 participants sat in pre-test and after the teaching intervention, 129 participants sat in post-test. In this paper, the data is drawn from the pre-test, post-test, and observations of groups during

meetings, selected because of its relevance to the learning goals and hypothetical learning trajectories related to the activities being reported on.

**RESULTS AND DISCUSSION**

**Activity 1 – Decomposing decimals**

The first activity involved decomposing two decimal numbers, i.e., 1.230 and 0.123 in terms of place value as shown in Figure 3a and 3b. For each decimal number, columns to draw sketches of the LAB representation of the numbers as well as columns to decompose the number in up to 8 ways into ones, tenths, hundredths, and thousandths are presented. By encouraging pre-service teachers to sketch the representations of the numbers, it is expected they will use the LAB model (introduced at the previous meeting) to assist them structuring their solutions.

We found that most groups could find 5 or more different ways to express 1.230 or 0.123. However, their sketches reflected different mathematical understandings, which can be categorized as showing 10-structure, 5-structure and no-structure. Sketches with 10-structure and no-structure are presented in figure 3a and b below. Note that in Indonesian context, we use a decimal comma instead of a decimal point.

	Sketsa	Berapa banyak satuan	Berapa banyak seper-sepuluh	Berapa banyak seper-seratus	Berapa banyak seper-seribu
1,230		1	2	3	0
1,230		1	2	2	10
1,230		1	2	1	20
1,230		1	2	0	30
1,230		1	1	13	0
1,230		1	1	12	10
1,230		1	1	10	30
1,230		1	1	5	30

Figure 3a: structure of 10

	Sketsa	Berapa banyak satuan	Berapa banyak seper-sepuluh	Berapa banyak seper-seratus	Berapa banyak seper-seribu
0,123		0	1	2	3
0,123		0	0	12	3
0,123		0	1	0	23
0,123		0	0	0	123
0,123					
0,123					
0,123					
0,123					

Figure 3b: no structure

Unfortunately, of 30 groups, only 6 groups reflected the 10-structure in their sketches. Four groups showed a combination of structure of 5 and 10-structure in their sketches with dominant 5-structures, and 20 groups showed no structure. This

finding suggests that even though most groups could complete many possible alternatives for decomposing decimal numbers, they did not emphasize base ten structures in their solution, which is very important for teaching.

The researcher also observed that most groups did not work with the LAB model when sketching decimal representations. Instead they found solutions arithmetically by using addition, subtraction, multiplication, and division. Prior learning experiences in decimals with heavy emphasis on symbolic manipulation might cause them to be more comfortable working on the problems arithmetically. The fact that models have not been used as a thinking tool indicated that the use of LAB model has not been well integrated in this activity, and provides a challenge for the next design research cycle.

Indications of impact of the activity 1 will be discussed by comparing pre-service teachers performance in pre-test and post-test items in a pair of item described in Figure 4. For each of the item, four alternatives are sought.

Pre : 0.375 = ... ones + ... tenths + ... hundredths + ... thousandths
Post: 0.753 = ... ones + ... tenths + ... hundredths + ... thousandths

Figure 4: Pre-test and post-test items investigating decomposition of decimals

In this case, we looked closely at pre-service teachers who sat in both pre-test and pos-test (N=118) comprised of 51 pre-service secondary and 67 pre-service primary. In analysing the number of correct answers, we categorize blank answers as wrong answers. Comparison between pre-test and post-test performance showed that both cohorts made an improvement. Figure 5 below represents the percentage of pre-service teachers in each cohort with the number of correct alternatives. Pre-service secondary showed an improvement as can be noticed from the decrease in the number of answers with incorrect alternatives and the increase in the number of answers with four correct alternatives. Similarly, pre-service primary also showed an improvement after the teaching sessions.

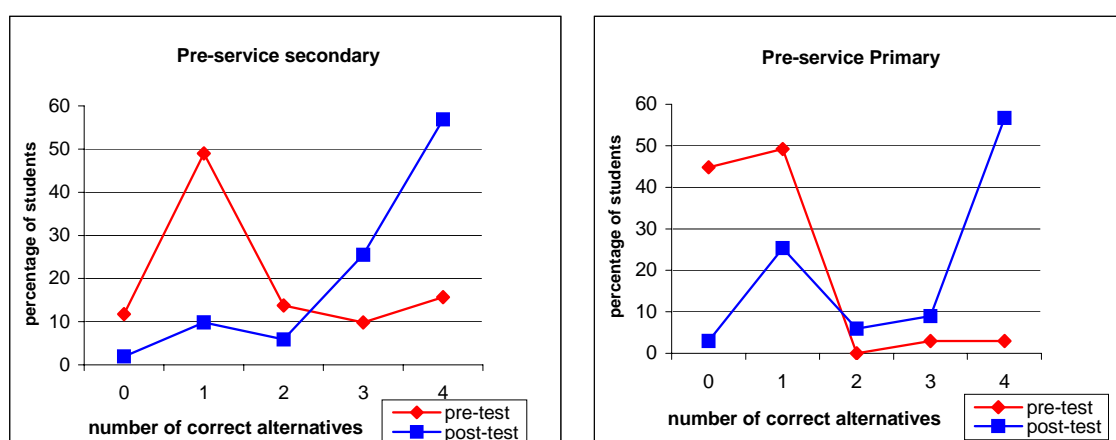

Figure 5: Comparison of Figure 1 pre-test and post-test item

Apparently pre-service secondary had a stronger performance in pre-test compare to pre-service primary cohort. However both cohorts started with about 50% students giving only one correct alternative, i.e., 0.375 is 0 one + 3 tenths + 7 hundredths + 5 thousandths. Interestingly, both cohorts also had almost the same percentage of students answering four out four alternatives at the post-test. This result suggested that both groups gained advantage from the teaching intervention. Pre-service primary cohort showed high improvement as the average number of correct answers given was 0.72 rose to 2.92 out of 4. Meanwhile the average number of correct answers of pre-service secondary rose from 1.67 to 3.26 out of 4.

About 16% of pre-service primary cohort gave 4 blanks in the pre-test, which contributes to the higher percentage of wrong answers in pre-service primary pre-test as can be observed in Figure 5. In contrast, we found no answers with 4 blanks from pre-service secondary cohort.

Some responses to this item in the pre-test suggested a lack of place value understanding as indicated by simply re-ordering the decimal digits, for instance,  $0.375 = 5 \text{ one} + 7 \text{ tenths} + 3 \text{ hundredths} + 0 \text{ thousandths}$ ,  $0.375 = 0 \text{ one} + 5 \text{ tenths} + 7 \text{ hundredths} + 3 \text{ thousandths}$ , or  $0.375 = 0 \text{ one} + 7 \text{ tenths} + 3 \text{ hundredths} + 5 \text{ thousandths}$ . Fortunately the number of such responses dropped in the post-test.

The improvement from pre-test to post-test might be considered as a logical consequence after pre-service teachers' participation on activity 1. However, evidence from their responses to other post-test items leads us to believe that some of pre-service teachers also translated these ideas of decomposing decimals into their ideas for future teaching. In response to a post-test item asking ideas to help children to solve 0.3:100, one pre-service teacher used extended notation of  $0.3 = 0 + 3 \text{ tenths} = 0 \text{ ones} + 0 \text{ tenth} + 30 \text{ hundredths} = 0 \text{ ones} + 0 \text{ tenths} + 0 \text{ hundredths} + 300 \text{ thousandths}$  and then by dividing 300 thousandths by 100, getting 3 thousandths or 0.003. Similarly another pre-service teacher suggested the use of LAB model to represent 0.3 not using 3 tenths but using 300 thousandths.

In another post-test item asking their ideas to help students determining the larger decimals of 0.7777 and 0.770, 19 pre-service teachers mentioned they will use extended notation of decimals to help children see that 0.7777 is larger than 0.770. Even though only a minority of pre-service teachers responded this way, these results are encouraging and the future design cycle will aim to extend this effect.

### **Activities 2 & 3: Comparing models & reflections on future teaching**

In Activity 2, pre-service teachers were introduced a number expander, to help them check their decomposition of decimals. Following that, they were asked to compare the LAB and the number expander as models. Concerning the relationships between LAB and a number expander, two groups mentioned that both models were related to Bruner's representations. These groups classified LAB as an enactive model and the number expander as a symbolic model. Another group also pointed out that LAB represented ones, tenths, hundredths, and thousandths in concrete ways whereas the number expander represented them in more symbolic ways using numbers and verbal

names. Three groups linked their comment directly to the previous activity and pointed out that both models can “show” how to express a decimal number in different ways.

In activity 3, pre-service teachers were asked to write about their new experiences and their ideas for future teaching of decimals gathered from these activities. In their reflection, many of them pointed out that they had not learnt about different ways of decomposing a decimal number before. Their experience was limited to one form of decomposing 0.123 as 0 one + 1 tenth + 2 hundredths + 3 thousandths.

They also pointed out the fact that this was their first experience of using concrete models in learning decimals. Their experiences with models in these activities have inspired them to find other models that can help them to teach decimals in more concrete ways as expressed in the following quotes:

“This is the first time we use manipulatives in learning decimals so we become more creative in finding new ways of teaching decimals, for instance using paper strips, or plasticine with similar principle to LAB. We also found a concrete way of finding the place value of decimals and we can use concrete manipulatives such as LAB and the number expander later in our teaching, which we haven’t used before. We also experienced new approaches in our learning by finding solutions by ourselves, sharing among different groups, and getting feedbacks from the lecturer”.

“We learnt that decimals which used to be taught only using numbers, in fact can be represented with concrete materials so that students can actively involved in learning and understand better. For me, in comparing decimals such as 0.123 and 0.1231, I used to round it and concluded that  $0.123 = 0.1231$  but after this, I know that  $0.1231 > 0.123$  because when I use LAB to compare them, I can see that 0.1231 is longer than 0.123”.

“Before we introduce how to do decimal computation, we try to introduce decimals using an LAB. The goal is to help them to understand the meaning of a decimal number, not only be able compute with decimals. Using that model, a student can explore their ideas in a more active way so then they can do calculation problem more easily”.

The first and third comments suggest that the role of models in helping them to create meaningful interpretation of decimals. All comments expressed the contribution of models in creating an active learning atmosphere. However, we could not find any *specific* ideas of how the models will be incorporated in ideas for teaching decimals except for the second quote.

## CONCLUSION

The evidence from the study of the first cycle for these activities signified the importance of constructing a meaningful interpretation of decimal notation in terms of place value. The finding suggested the need for the next cycle to design activities where the physical use of the model is a more integrated part of the pre-service teachers’ activity, so they do not answer questions simply by relying on previously learned syntactic rules. Even though most pre-service teachers noted the important role of the models in their reflections and suggested that they will use them for their future teaching, only a limited numbers of pre-service teachers can explicitly express

their ideas using models. We hope the design for the next cycle will improve these aspects of the activities and there will be more pre-service teachers who can link their experiences with the activities with their improved ideas for teaching decimals.

## References

- Gravemeijer, K. (2004). Local Instruction Theories as Means of Support for Teachers in Reform Mathematics Education. *Mathematical Thinking and Learning*, 6(2), 105-128.
- Hiebert, J. (1992). Mathematical, Cognitive, and Instructional Analyses of Decimal Fractions. In G. Leinhardt, R. Putnam & R. A. Hattrup (Eds.), *Analysis of Arithmetic for Mathematics Teaching* (pp. 283-322). Hillsdale, New Jersey: Lawrence Erlbaum Associates.
- Irwin, K. C. (1995). Students' Images of Decimal Fractions. In L. Meria & D. Carraher (Eds.), *Proceedings of the 19th Conference of the International Group for the Psychology of Mathematics Education* (Vol. 3, pp. 3-50 - 53-57). Recife- Brazil: PME.
- Listyastuti, H., & Aji, M. M. (2002a). *Matematika Kelas 6 SD*. Klaten: PT Intan Pariwara.
- Listyastuti, H., & Aji, M. M. (2002b). *Matematika, Kelas 5 SD*. Klaten: PT Intan Pariwara.
- Peled, I., & Shabari, J. A. (2003). Improving Decimal Number Conception by Transfer from Fractions to Decimals. In N. A. Pateman, B. J. Dougherty & J. Zilliox (Eds.), *Proceedings of the 27th Conference of the International Group for the Psychology of Mathematics Education* (Vol. 4, pp. 1-6). Hawaii: PME.
- Putt, I. J. (1995). Preservice Teacher Ordering of Decimal Numbers: When More is Smaller and Less is Larger! *Focus on Learning Problems in Mathematics*, 17(3), 1-15.
- Stacey, K. (2005). Travelling The Road to Expertise: A Longitudinal Study of Learning. In H. L. Chick & J. L. Vincent (Eds.), *Proceedings of the 29th Conference of the International Group for the Psychology of Mathematics Education* (Vol. 1, pp. 19-36). Melbourne: PME.
- Stacey, K., Helme, S., Archer, S., & Condon, C. (2001). The Effect of Epistemic Fidelity and Accessibility on Teaching with Physical Materials: A Comparison of Two Models for Teaching Decimal Numeration. *Educational Studies in Mathematics*, 47, 199-221.
- Stacey, K., Helme, S., Steinle, V., Baturo, A., Irwin, K., & Bana, J. (2001). Preservice Teachers' Knowledge of Difficulties in Decimal Numeration. *Journal of Mathematics Teacher Education*, 4, 205-225.
- Steinle, V., & Stacey, K. (2003). Exploring the Right, Probing Questions to Uncover Decimal Misconceptions. In L. Braggs, C. Campbell, G. Herbert & J. Mousley (Eds.), *Proceedings of the 26th Annual Conference of the Mathematics Education Research Group of Australasia* (Vol. 2, pp. 634-641). Geelong: MERGA.
- Steinle, V., Stacey, K., & Chambers, D. (2002). *Teaching and Learning about Decimals CD* (Version 2.1). Melbourne: The University of Melbourne.



# IMPETUS TO EXPLORE: APPROACHING OPERATIONAL DEFICIENCY OPTIMISTICALLY

Gaye Williams

Deakin University

*'Impetus to explore' is studied through post-lesson video-stimulated student interviews. This impetus focuses 'spontaneous' decisions to explore unfamiliar mathematics. Uncertainty, quests for elegance and curiosity have been found to contribute to this impetus. This study identified other contributing factors: inability to undertake the teacher's task, 'optimistic explanatory style' (Seligman, 1995), and identifying relevant complexities (Williams, 2002). Explanatory style affects how a person perceives successes and failures. Enactment of optimism in this study illuminated its role in creating an impetus to explore. Re-conceptualising 'operational deficiency' (Chen & Siegler, 2000) to include absence of resources to undertake a task illuminated a task design feature that can increase exploration.*

## INTRODUCTION

This is a study of how an inability to proceed with the teacher's task can sometimes lead to 'spontaneous' exploratory activity. It focuses upon the factors that contribute to a spontaneous decision to explore in such cases. The term 'spontaneous' refers to student-directed activity over a time interval when there is no mathematical input from external sources (see Williams, 2004). This study is part of a broader study of creative mathematical thinking and the social and personal influences upon this thinking (Williams, 2005b). One case is used to illustrate the findings from this study. Some other cases have previously been reported (e.g., Williams, 2003b, 2005a).

## THEORETICAL FRAMEWORK

Uncertainty, quests for elegance, and curiosity can lead to an 'incentive to enquire' or 'impetus' to move to a higher level of thinking (see, Goodson-Espy, 1998). This impetus to explore has been identified as an area requiring further study (Goodson-Espy, 1998). Chen and Siegler (2000) found that exploratory activity sometimes occurred when toddlers experienced difficulty manipulating a tool to drag a toy (operational deficiency) towards them on across a table (e.g., they tried another tool, or leaned over to try to reach the toy). This study examines how exploratory activity can result when students are unable to carry out a *mathematical* task to meet a teacher-set goal. To examine why some students 'spontaneously' explored, Seligman's (1995) dimensions of optimism/resilience (permanent-temporary, pervasive-specific, personal-external) were employed to find how students perceived the failures they encountered. It was hoped that evidence of students enacting 'optimism' during lessons would be found. A child with an optimistic explanatory style (Seligman, 1995) perceives successes as 'permanent' ("I

succeeded, I can do this”), ‘pervasive’ (“I succeeded, I am good at this”), and ‘personal’ (“I achieved this”), and failures as ‘temporary’, ‘specific’, and ‘external’ (“I failed this time, I will examine the situation to see what I can change to increase my chances of succeeding next time”). Seligman linked the building of optimism with success in flow situations. Flow (Csikszentmihalyi, 1992 in Williams, 2002) is a state of high positive affect during creative activity. This state occurs during mathematical exploration when a student identifies a mathematical complexity, spontaneously decides to explore it, and subsequently develops new conceptual knowledge (Williams, 2002). This success in creating new knowledge is seen as optimism building. Thus, impetus to explore is linked to the creation of flow situations.

This study examines the nature of the ‘failures’ students encountered when they tried to undertake the mathematical task set by the teacher. It also examines the personal characteristics of the students and the ways they found to circumvent the failures they encountered. The study is focused by the research question: “What factors contribute to an impetus to explore when a student is unable to undertake the mathematical task as set by the teacher?”

## RESEARCH DESIGN

Data was generated as part of the international Learners’ Perspective Study. Six Year 8 classes (from Australia and the USA) were studied to find evidence of creative student thinking. Data was collected from each classroom over at least ten consecutive lessons. Three cameras simultaneously captured the activity of the teacher, a different pair of focus students each lesson, and the whole class. A mixed video image was produced during the lesson (focus students at centre screen and teacher as an insert in the corner). This mixed video image was used to stimulate student reconstruction of their thinking in post-lesson interviews and the video image from the teacher tape stimulated teacher discussion. Students (and the teacher) were asked to identify parts of the lesson that were important to them, and discuss what was happening, and what they were thinking and what they were feeling. Through this process, students who explored mathematical complexities to generate novel mathematical ideas and concepts were identified and social and personal influences upon their thinking were made explicit through their discussion of the lesson video.

Ericsson and Simons (1980) have shown that verbal reports can provide valid data when attention is given to research design. The interview probes fitted with Ericsson and Simon’s (1980) findings about how to generate high quality verbal data associated with cognitive activity. Salient stimuli (mixed image lesson videos) were used to stimulate student reconstruction, probes focused on lesson activity and what students were thinking (rather than the interviewer asking general questions), and students focused the content of the interview through what they attended to in the lesson video. Ericsson and Simons have shown that where the researcher asks specific questions that include constructs the subject has not previously reported,

the subject is more likely to “generate answers without consulting memory traces” (Ericsson & Simons, 1980, p. 217). On the other hand, if a subject spontaneously “described one or more specific sub-goals, and these were both relevant to the problem and consistent with other evidence of the solution process” (Ericsson & Simons, 1980, p. 217) there was stronger evidence that the reported activity occurred.

Interviews, in conjunction with the lesson video, were used to identify intervals of time from when students first encountered difficulties with the teacher’s task to when they spontaneously explored an identified complexity. To identify social and personal influences contributing to the impetus to explore in such situations, simultaneous analysis of student enacted optimism (Seligman, 1995) and the social and cognitive elements of the process of abstracting (Dreyfus, Hershkowitz, & Schwarz, 2001) was undertaken. These are elaborated through the illustrative case.

### SITES, SUBJECTS AND CONTEXT

Only 5 of 86 students were identified creatively developing novel mathematical ideas and concepts. These five students varied in their mathematical performances, cultural backgrounds, socio-economic status, gender and the classes they attended. Other students in these classes may have engaged in spontaneous exploratory activity during the research period and not been identified because two students were the primary focus of study each lesson. There were occasions (including this illustrative case) where the student identified spontaneously exploring was not the focus student that lesson. In such cases, the student was selected as a focus student the following lesson. The validity of evidence that relied heavily on interview reconstruction has been justified in descriptions of how the interview was undertaken (see above). The student in this case (Eden) was visible on the student camera when he moved across to view Darius’ screen. At other times he was visible on the whole class camera.

As three students undertook spontaneous exploratory activity on more than one occasion, eight spontaneous explorations were identified in total. Each of the five students was found to have an optimistic explanatory style (Williams, 2003a). Curiosity (2 students), a quest for elegance (2 students), or operational deficiency—lack of adequate resources to perform the teacher task—(4 students) contributed to their impetus to explore. Operational deficiencies differed in nature: absence of appropriate cognitive artefacts (3 students including Eden, e.g., see Williams, 2003b) or absence of physical resources (1 student, see Williams, 2005a).

Eden attended an Australian inner-suburban government school. The students in this class had all achieved high results in mathematics the previous year. The student population was drawn from across the city because the school had a high academic reputation. Students’ socio-economic and cultural backgrounds varied markedly.

Eden sat quietly in class, listened, and undertook the required work. He did not engage in the types of disruptive classroom activity that were often instigated by one of his out-of-class friends. He was a conscientious independent thinker who scored in

the top 5% for mathematical problem solving on a national test. His teacher perceived him as an average student in mathematics and had decided not to recommend him for the advanced stream the following year. Eden displayed indicators of optimism (Seligman, 1995) on all three dimensions in his post-lesson interview and no indicators of lack of optimism (see Table 1). Table 1 lists the three dimensions of optimism [Column 1] and the indicators of optimism [Columns 4, 5] and indicators of lack of optimism [Columns 2, 3] in relation to both successes and failures.

Eden perceived prior learning as able to help in “a similar circumstance” (Success as Permanent), that “work[ing] everything out for yourself ... you will be able to think clearer” (Failure as Temporary), and that individual effort would lead to success (Success as Personal). Eden’s teacher’s perception that he had average ability in mathematics was contrary to the evidence from the problem solving questions on a national test. Rather than perceiving ‘failure’ (his teacher’s perception of him as average) as a personal attribute (Failure as Pervasive), Eden constrained his use of the term average to the classroom in which that assessment was made. “*In the class* [researcher’s emphasis]” he was average and there was “no way to explain it” (Failure as Specific to the class; Failure as External, it was the assessment of another). Eden preferred problem solving to work on basic skills.

Problem solving's pretty good to work out and stuff ... you've gotta (pause) use your mind a little bit more than just (pause) know how to add up sums and stuff [Eden, post-lesson interview].

In the *atypical* lesson under study (Lesson 6, where the teacher did not present a rule and expect students to practise it), students were seated side by side at with their own computers (Eden next to Darius). The teacher stated the general equation for a linear function without discussing the role of the constants, and students commenced the game ‘Green Globes’. Green Globes is a computer game that displays a Cartesian Axes System with 13 randomly placed ‘globes’ on integer co-ordinates. Trajectories of linear graphs are used to hit globes. Students input linear equations and obtain larger scores when they hit more globes with a single line (one for the first globe hit, two for the second, four for the third and so on). Although the class had not studied linear functions previously, Eden’s Year 7 teacher had accelerated some students: “last year we did a bit on this stuff except I had forgotten *most* of it” [Eden’s interview]. Eden was initially unaware of the general equation for a linear function, did not know that real number laws applied within an algebraic equation, and did not know what a gradient was. Students chose their own directions of exploration, and discussed ideas with those around them. When asked questions, the teacher provided assistance with the computer program but did not give directions or hints on how to proceed with the game. Darius was intent upon manipulating numbers to hit globes and gain a high score. Eden wanted to know why equations positioned the lines as they did: “I didn't exactly know *why* it always happened like that” [Eden’s post-lesson interview].

**Transcript notation used in this paper:** ... transcript omitted without altering meaning;  
- change in flow of talk; [text ] researcher explanations within transcript

Table 1 Eden: Indicators of an optimistic explanatory style identified by discourse analysis of his post-lesson interview

Dimension	Indicators of Optimism		Failure
	Success	Success	
<b>Permanent-Temporary</b>	<p>* Transcript containing multiple indicators</p>	<p>“Once you have learnt it ... helps a lot anything that is ... in a similar circumstance”</p> <p>“You've gotta (pause) use your mind a little bit more [in problem solving] than just (pause) know how to add up sums and stuff”</p> <p>“I learnt how to do it pretty well”</p>	<p>“You just have got to sort of think out the answers in your head [in problem solving] (pause) occasionally you have gotta- got to write down on paper what you are thinking about (pause) and eventually get the answer”</p> <p>*“You try to work everything out for yourself because ... you will be able to think clearer [than if you ask]”</p> <p>*“I don't really (pause) ask too many people ... I sort of just try to work things out ... and I skip a question if I have to”</p>
	<p>“It's good for you I think [problem solving]”.</p> <p>“I was always pretty good at maths at my old school”.</p>	<p>* “Well I (pause) in the class I think I am (pause) pretty much average in the class (pause) because (pause) I've always get pretty average scores on the tests so (pause) I'm basically just average I (pause) no way to explain it”.</p> <p>“I tried to use em except (pause) I couldn't use em as accurately [diagonal lines]”</p> <p>“I can do it better on paper than on the game- most of it [showed how to get the equation as he did in the Green Globbs lesson]”.</p> <p>* “Well I (pause) in the class I think I am (pause) pretty much average in the class (pause) because (pause) I've always get pretty average scores on the tests so (pause) I'm basically just average I (pause) no way to explain it”</p>	
<b>Personal-External</b>	<p>*“You try to work everything out for yourself because ... you will be able to think clearer [than if you ask]”</p> <p>“[When problem solving] You just have got to (pause) sort of think out the answers in your head (pause) occasionally you have gotta- got to write down on paper what you are thinking about (pause) and eventually get the answer”.</p> <p>*“I don't really (pause) ask too many people ... I sort of just try to work things out ... and I skip a question if I have to”.</p>	<p>*“You try to work everything out for yourself because ... you will be able to think clearer [than if you ask]”</p> <p>“[When problem solving] You just have got to (pause) sort of think out the answers in your head (pause) occasionally you have gotta- got to write down on paper what you are thinking about (pause) and eventually get the answer”.</p> <p>*“I don't really (pause) ask too many people ... I sort of just try to work things out ... and I skip a question if I have to”.</p>	<p>* “Well I (pause) in the class I think I am (pause) pretty much average in the class (pause) because (pause) I've always get pretty average scores on the tests so (pause) I'm basically just average I (pause) no way to explain it”</p>

## ANALYSIS AND RESULTS

Eden spent 15 minutes trying to find how to generate sloping lines that hit globs. For a start (12:50 Mins into the lesson), he asked Darius; “What's the rule for that [sloping line on Darius' screen]? That's the sort of angle” and at 27:54 Mins he still did not know “[Eden to Darius generating Figure 1] I don't know how you get that”.

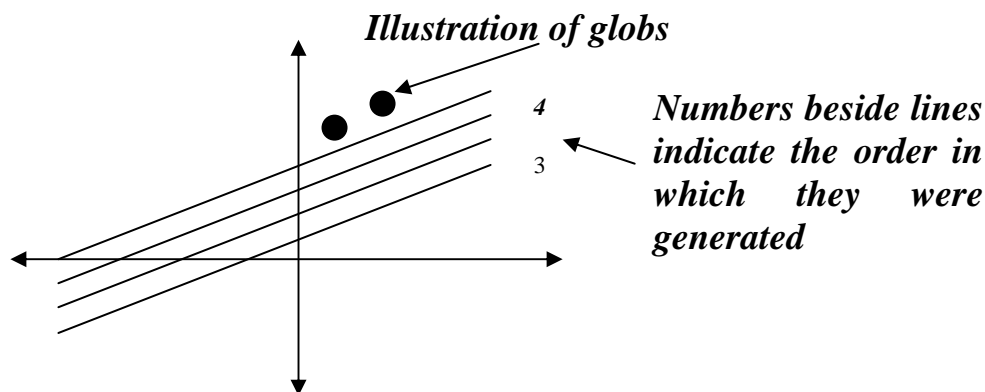

Figure 1. The display Darius was generating on his screen at 27:54 Mins

During those 15 minutes, Eden worked out how to generate horizontal lines and that real number operations apply within equations. At 27:54 Mins, when Darius did not respond, Eden remained motionless, watching the dynamic display Darius generated [27:58-28:15 Mins] before returning to his own computer and working intently for seven minutes [captured on the whole class camera] then exclaiming: “ $y$  ... crosses over with  $x$ ” [35:12 Mins]. He described what he had realised in his interview: “Well (pause) the graph's drawn up already (pause) for you to look at- that's the only help you get to answer”. He pointed to the graph and later a table to aid his explanation:

You have to work out (pause) what  $y$  was (pause) which was ... minus three (pause) minus two (pause) minus one (pause) and zero ...  $y$  is all the time it is always one behind it ... Then the rule (pause) is ah (pause) would be (pause) um (pause)  $y$  (pause) equals (pause)  $x$  (pause) minus one”

Eden focused *simultaneously* on the  $y$  value and  $x$  value of each co-ordinate (‘synthetic-analysis’, a subcategory of ‘building-with’, see Dreyfus, Hershkowitz, & Schwarz, 2001; Williams, 2005a) and described the relationship (when  $y$  is minus three,  $x$  is minus two, when  $y$  is minus one,  $x$  is zero). After ‘recognizing’ this relationship (the  $y$  value is always one less than the  $x$  value), Eden formulated the equation (‘constructing’, Dreyfus, Hershkowitz, & Schwarz, 2001). Focusing his attention idiosyncratically on Darius’ screen, Eden identified a complexity (the relationship between the  $y$  and  $x$  values) and spontaneously explored its potential.

## DISCUSSION AND CONCLUSIONS

Eden lacked the necessary cognitive artefacts to proceed with the Green Globs game using the general equation given, so he found a way to proceed using relationships between  $x$  and  $y$  values of ordered pairs instead. Kerri (Williams, 2005a) forgot her graph paper in a test so used a sketch and the Cartesian Axis System in a way that she

had not been taught. Dean (Williams, 2003b) could not recognize angles in polygons so drew upon the '180 degrees in each triangle' rule instead (a connection not made in class). In each case, the student encountered an operational deficiency (absence of cognitive or physical resources) that denied them access to the mathematics the teacher required. Undeterred by this 'failure' these optimistic students searched for a way to circumvent the difficulty they encountered. Thus, they identified an unfamiliar mathematical complexity that appeared potentially productive and impetus to explore resulted. Operational deficiency, optimism, and identifying a relevant complexity, *together* contributed to the impetus to explore.

For example, Eden persevered when he could not generate sloping lines, because he perceived failure as temporary and able to be overcome through personal effort. He did not consider his failure as confirming a negative attribute of himself but rather perceived the failure as specific to the situation. Thus, he changed aspects of his exploration to find a way to overcome his difficulties (e.g., changed the type of line studied, considered legitimate operations with symbols, changed his focus from the equation to the co-ordinates) (Failure as Specific not Pervasive). Eden's perception that failure was specific was crucial to his finding a mathematical complexity that focused his spontaneous exploration. Eden displayed indicators of optimism in his interview and enacted optimism in his response to failure in class. This supports Sfard and Prusak's (2005) position: "[we can] accept the discourse as such ... Words are taken seriously and shape one's actions" (Sfard & Prusak, 2005, p. 51).

Both Eden's optimism, and the complexity he identified through his optimistic activity contributed to his impetus to explore. Without the failure arising from his operational deficiency, his optimistic response to failure may not have been activated and the complexity that led to new insight may not have been identified. Eden created a flow situation when he spontaneously decided to explore an identified complexity to develop new knowledge (Williams, 2002). Theoretically, success with this activity should strengthen his optimistic orientation (Seligman, 1995). Longitudinal studies are required to collect empirical evidence of this theorised link. Tasks like Green Globes, with many opportunities for students with varying mathematical backgrounds to encounter operational deficiencies, would assist in creating opportunities for students to experience flow and researchers to study optimism-building activity.

**Acknowledgement.** This data was collected through the Learners' Perspective Study and the analysis was undertaken at the International Centre for Collaborative Research, University of Melbourne. My thanks to all.

## References

- Chen, Z., & Siegler, R. (2000). Across the great divide: Bridging the gap between understanding of toddlers' and older children's thinking. *Monographs of the Society for Research in Child Development*, 65(2, Serial No. 261), 1-96.
- Dreyfus, T., Hershkowitz, R., & Schwarz, B. (2001). The construction of abstract knowledge in interaction. In M. van den Heuvel-Panhuizen (Ed.), *Proceedings of the*

## Williams

- 25th conference of the International Group for the Psychology of Mathematics Education (Vol. 2, pp. 377-384). Utrecht, The Netherlands: PME.
- Ericsson, K., & Simons, H. (1980). Verbal reports of data. *Psychological Review*, 87(3), 215-251.
- Goodson-Espy, T. (1998). The roles of reification and reflective abstraction in the development of abstract thought: Transition from arithmetic to algebra. *Educational Studies in Mathematics*, 36, 219-245.
- Seligman, M. (with Reivich, K., Jaycox, L., Gillham, J.). (1995). *The Optimistic Child*. Adelaide: Griffin Press.
- Sfard A., & Prusak, A. (2005). Identity that makes a difference: Substantial learning as closing the gap between actual and designated identities. In H. Chick & J. Vincent (Eds.), *Proceedings of the 29th conference of the International Group for the Psychology of Mathematics Education* (Vol. 1, pp. 37-52). Melbourne, Australia: PME.
- Williams, G. (2002). Associations between mathematically insightful collaborative behaviour and positive affect. A. Cockburn & E. Nardi (Eds.), *Proceedings of the 26th conference of the International Group for the Psychology of Mathematics Education* (Vol. 4, pp. 402-409). Norwich, UK: PME.
- Williams, G. (2003a). Associations between student pursuit of novel mathematical ideas and resilience. In L. Bragg, C. Campbell, G. Herbert & J. Mousley (Eds.), *Mathematical education research: Innovation, networking, opportunity* (Vol. 2, 752-759). Sydney: Mathematics Education Research Group of Australasia.
- Williams, G. (2003b). Empirical generalisation as an inadequate cognitive scaffold to theoretical generalisation of a more complex concept. In N. Patemen, B. Dougherty & J. Zilliox (Eds.), *Proceedings of the 2003 Joint Meeting of the International Group for the Psychology of Mathematics Education and the Group for the Psychology of Mathematics Education Meeting of North America*, (Vol. 4, pp. 419-426). Hawai'i, Honolulu: PME.
- Williams, G. (2004). The nature of spontaneity in high quality learning situations. In M. Hoines & A. Berit Fuglestad (Eds.), *Proceedings of the 28th conference of the International Group for the Psychology of Mathematics Education* (Vol. 4, pp. 433-440). Bergen, Norway: PME.
- Williams, G. (2005a). Consolidating one structure whilst constructing two more. In H. Chick & J. Vincent (Eds.), *Proceedings of the 29th conference of the International Group for the Psychology of Mathematics Education* (Vol. 4, pp. 413-420). Melbourne, Australia: PME.
- Williams, G. (2005b). *Improving intellectual and affective quality in mathematics lessons: How autonomy and spontaneity enable creative and insightful thinking*. Unpublished doctoral dissertation, University of Melbourne, Melbourne, Australia.



# GENERATING AND EVALUATING GEOMETRY CONJECTURES WITH SELF-DIRECTED EXPERIMENTS

Chao-Jung Wu<sup>\*)</sup>, Wing-Kwong Wong<sup>\*\*)</sup>, Ying-Hao Cheng<sup>\*\*\*)</sup>, Yunn-Wen Lien<sup>\*\*\*\*)</sup>

<sup>\*)</sup>National Taipei University of Education, <sup>\*\*)</sup>National Yunlin University of Science & Technology, <sup>\*\*\*)</sup>China University of Technology, <sup>\*\*\*\*)</sup>National Taiwan University

*Domain-general inductive skills are important in science, math, and other disciplines but are difficult to teach directly. We have designed a computer-assisted learning environment called InduLab for learners to perform inductive tasks with self-directed experiments. In the experiment, 50% of 66 fourth grade students could find exterior angle property by themselves. Even though computer provided the information of Angle 3, only 33% students mentioned conjectures of Angle 3 and around 10% students found that the sum of the angles of a triangle equals 180 degrees. We suggest two was in explaining the data. In self-directed experiments, the students seemed to go through two phases in generating positive examples and evaluating conjectures. Besides, students used control variable strategy and fine adjustment strategy to generate positive examples.*

## INTRODUCTION

In the introduction of Mathematics and plausible reasoning Vol. I (pp. V –VI), Polya (1954) pointed out all knowledge outside mathematics consisting of conjectures, including the general laws of physical sciences, the documentary evidence of historians, and the statistical evidence of economists. Mathematics is regarded by many as a demonstrative science, but Polya thinks that the formation of mathematics has no differences from any other knowledge. You have to guess a mathematical theorem before you prove it. If the learning of mathematics reflects to any degree the invention of mathematics, it must have a place for guessing and plausible reasoning. Steen (1988) also mentioned that the features of mathematics have been transformed from numbers, quantities, and figures to the science of pattern. The mathematician seeks patterns in number, space, science, and imagination. Applications of mathematics use the patterns to explain and predict natural phenomena that fit the patterns. These all emphasize the importance of developing discovery patterns in mathematics.

Bruner (1961) proposes many advantages of learning by self-directed discovery. He mentioned that the essence of learning by discovery is the recognition of patterns with the organization of data. Therefore, the component skills of learning by discovery are important objectives of education: data collection, hypothesis generation, and hypothesis evaluation. On the other hand, Bruner (1961) admitted that it is not clear how to teach the skills of pattern discovery and problem solving. The best way we know how is to let learners practice learning by discovery as much as possible. In order for children learners to discover patterns of data actively, they

must possess the skills of discovery. Unfortunately, in previous studies of self-directed experiments, children showed a number of weaknesses in data collection, hypothesis generation and evaluation (Zimmerman, 2002). This might lead to unproductive experiments of trial and error and hence the children's loss of interest. In order to address some of these weaknesses of children learners, we have designed a computer-assisted learning environment called InduLab (Fig. 1) for them to practice learning by discovery.



Figure 1. InduLab records four experiments and visualizes the experiments 3, 4.

The skills of inductive tasks, though domain-independent, can be applied to many domain-specific scientific disciplines, including geometry. Geometry is a subject that can make good use of inductive as well as deductive skills. Positive and negative examples of geometric figures can be used to illustrate various geometric concepts and properties. The inter-class relationships among geometric concepts, e.g., subset, superset and intersection, relate the concepts of sets to those of sufficient/necessary conditions on geometric attributes. These concepts are fundamental in the learner's development of the skills of informal reasoning, up to the deductive skills in proving geometry theorems in middle school.

### SYSTEM DESCRIPTION AND PREVIOUS STUDY

For the sake of illustrating the functions of the current version of InduLab, we use an example of discovering some properties of the angles of triangle. In this task, a user can freely set the values of two interior angles (Angle1 and Angle2) and the exterior angle (Angle R) of Angle3. After the values are set, InduLab will animate the formation of the target triangle (if Angle 1+Angle 2=Angle R) or non-triangle (otherwise) by showing the rotation of the Angle R. The values of Angle 1, Angle 2, Angle R, and Angle 3 (the value of Angle 3 is computed by computer), and whether a triangle is formed will be recorded in a table automatically.

After a number of experiments, the experimenter will ask users' conjectures of angles in the current version of InduLab. Users can point out 2 related properties of angles

of a triangle: 1. Exterior angle property:  $\text{Angle } 1 + \text{Angle } 2 = \text{Angle } R$ . 2. Interior angle property:  $\text{Angle } 1 + \text{Angle } 2 + \text{Angle } 3 = 180$ .

InduLab provides some tools to help the user induce the target properties. In order to reduce memory loading and enhance data organization, InduLab provides a data table for recording the data of all experiments. The table is shown in the left lower part of Figure 1. Each row in the table records the data of one experiment. Each column represents the value of a variable. The numbers by themselves might be difficult to understand. Therefore, InduLab provides a visualization tool to show the geometric meaning of the setting of an experiment. Furthermore, in order to help the user to make valid inferences from two related experiments, InduLab puts a visualization panel on top of another (right part of Figure 1) so that the user can compare two experiments visually. Even when two variables are related, e.g.,  $\text{Angle } 3 + \text{Angle } R = 180$ , the relation is difficult to detect from experimental data that are randomly placed in the table. Therefore, InduLab provides a tool to sort the experiments according to the ascending order of any variable. Another tool to help induction is that of data hiding. When the data of a variable are hidden, the user can focus her attention on the other variables.

From November to December in 2004, we provided a test for 12 fourth grade students who had not been taught properties of angle sum, exterior angle, and supplementary angle. During the test, the experimenter would not interfere and indicate the functions of hiding and sorting until students found 3 triangles. Students would be allowed to find out the rules of triangle formation within 35 to 65 minutes.

We found an interesting pattern of how some learners produced positive examples and generated conjectures. After the first positive example is found, the learner generates another positive example by adding a small number, say five degrees, to two variables. The strategy can be repeatedly used to generate more positive examples. Consider a typical learner, say Tom, in an empirical study. In his training stage, a positive example was found:  $\text{Angle } 1 = 75$ ,  $\text{Angle } 2 = 45$ ,  $\text{Angle } R = 120$ . Then he found another positive example by adding five degrees to both  $\text{Angle } 2$  and  $\text{Angle } R$ :  $\text{Angle } 1 = 75$ ,  $\text{Angle } 2 = 50$ ,  $\text{Angle } R = 125$ . A third positive example is obtained similarly:  $\text{Angle } 1 = 75$ ,  $\text{Angle } 2 = 55$ ,  $\text{Angle } R = 130$ . Then he produced a negative example by adding five degrees to each variable:  $\text{Angle } 1 = 80$ ,  $\text{Angle } 2 = 60$ ,  $\text{Angle } R = 135$ . So he was back to the previous adjustment pattern, and obtained three more positive examples continuously. Then Tom ran experiments with variables (in a wide degree change of  $\text{Angle } 1$ ) with very different values from previous experiments. After using CVS in the following experiments, he obtained another positive example. Two more similar episodes of experiments were ran, during which he seemed to be thinking a lot about how the variables were related. After hiding irrelevant variables and sorting out the experimental data, he finally found that  $\text{Angle } 1 + \text{Angle } 2 = \text{Angle } R$ . He also told the experimenter that he noticed that  $\text{Angle } 1 + \text{Angle } 2$  and  $\text{Angle } 3$  showed opposite trends: when one increased, the other decreased and vice versa. He also mentioned that  $\text{Angle } R$  and  $\text{Angle } 3$  also showed opposite trends.

Tom's experimental data indicate there were two distinct stages: generating positive examples by experiments and evaluating conjectures. Past studies indicated that students often used control variable strategy (CVS) (Chen & Klahr, 1999) in generating positive examples: the current experiment differs from the previous experiment for the value of one variable. Moreover, we also found another strategy of fine adjustment strategy (FAS): after the first positive example is found, the learner generates another positive example by adding a small number to a few variables, and maintaining some kind of conservatory relationship. For example, add five degrees to both Angle 1 and Angle R, or add five degrees to both Angle 1 and Angle 2, and then add ten degrees to Angle R. FAS does not guarantee the generation of positive examples all the time. For instance, Tom added five degrees to Angle 1, Angle 2, and Angle R of a positive example simultaneously and produced a negative example. After finding enough positive examples, Tom might have produced a conjecture. When he made big changes to the variables, we think that he was evaluating his conjectures. However, students discovered exterior angle property earlier than interior angle property. At school, the curriculum teaches the two topics in the reverse order.

This research aims to check whether the learner's manipulability of a variable influences the learner's discovery of geometric properties of the variable. Moreover, we want to understand better the learner's behavior in generating and evaluating conjectures. Because students' different capabilities might affect the performance in InduLab, we grouped participants by their SPM scores. Students were asked to use sorting and hiding tools and then reported their conjectures.

## METHOD

The participants were 66 fourth grade students from 5 elementary schools in Taiwan, and divided into 3 levels of High (80-90+), Median (40-60), and Low (10-30) by SPM (standard progressive matrices) percentile rank. From March to April in 2005, this experiment started progressing, sampled 22 participants from each level who had not been taught properties of interior and exterior angles in the class.

This was an individual experiment. For a participant to get used to the system, the experimenter would offer three sets of angle degrees to students with pens and paper on their right hand side. The participant would be asked "Did any one tell you or do you think what values of the interior angles would form a triangle in the computer?". The experimenter would tell the participant the purpose of this experiment was to find out rules for forming triangles. After finishing 6 trials, experimenter would demonstrate sorting and hiding data, and then asked participants "What do you think to set these angles and form a triangle?" the participant could sort their data and move all positive examples to the top of the table. At the end of each episode (six trials), the experimenter would record the participant's conjecture (called C6n). After 35 minutes or when the participant found one of the two rules:  $\text{Angle 1} + \text{Angle 2} = \text{Angle R}$  or  $\text{Angle 1} + \text{Angle 2} + \text{Angle 3} = 180$ , the experimenter would say "Well done! You found one rule to make up a triangle. How about try the other rule? "

Basically, the experimenter only needed to observe, record, and give emotional support to the participant without interfering during the experiment.

## RESULT

In average, the experimenter had 4 chances to obtain conjectures, and participants ran around 10~30 trials whose mean is 25 trials and whose standard deviation is 7.8. Under InduLad environment, we found: (1) The rate of discovering EA (53%) is higher than IA (12%) ( $z = 5.02, p < .001$ ) in Table 1. (2) Participants with different SPM levels had significantly different rates in discovering EA ( $\chi^2(2, N = 66) = 11.07, p < .01$ ). (3) Only High SPM group has higher discovering rate than the Low SPM group. (4) Because few participants discovered IA, there was no significant difference in the discovering rates in IA for different SPM grouped.

IA \ EA	Discovered	Non-discovered	Total
Discovered	7 (4, 2, 1) <sup>a</sup>	1 (0, 1, 0)	8 (4, 3, 1)
Non-discovered	28 (13, 10, 5)	30 (5, 9, 16)	58 (18, 19, 21)
Total	35 (17, 12, 6)	31 (5, 10, 16)	66 (22, 22, 22)

a: ( ) the number of high, median, and low SPM participants

Table 1: the number of different SPM participants in discovering EA and IA

In Table 1, 3 (one H, two M) out of 35 participants who found EA proposed another condition, e.g., Angle 1+Angle 2=Angle R, and Angle 1=Angle 2. If we eliminated 2 participants who had been told the angle sum of triangle was 180, only 7% participants discovered the angle sum of triangle. Because Angle 3 was not the value of variables, only 33% (High SPM 10, Median SPM 8, Low SPM 4) participants found the conjecture about Angle 3.

In order to distinguish the two stages of generating positive examples and evaluating conjectures, we calculated the variances of Angle 1 in 6 trials from the first and the last episode separately, and then divided the variance of the last episode by the first episode. If the learner's behaviour is similar to Tom's, the ratio should be greater than 1. And the ratio would be close to 1 only when there were no significant differences between the two stages. Angle 2 could be computed similarly.

There were few participants eliminated from 66 students because the variances of their first episodes were all 0. The ratio of Angle 1 was 8.50 which was significantly greater than theoretical ratio 1 ( $t(62) = 3.97, p < .01$ ). The ratio of Angle 2 was also obvious and reached 5.73 ( $t(64) = 2.35, p < .01$ ). As for the analysis of 3 levels of SPM participants, both 2 angles in High SPM showed significant differences. (M1 = 12.20,  $t(20) = 2.56, p < .05$ ; M2 = 4.92,  $t(21) = 3.08, p < .01$ ) And only Angle 1 in Median SPM reached significant status. (M1 = 7.74,  $t(21) = 2.94, p < .01$ ; M2 = 10.68,  $t(21) = 1.69, p > .05$ ). However, the ratios of the two angles in the Low SPM group did not show significant differences. (M1 = 5.43,  $t(19) = 1.59, p > .05$ ; M2 = 1.40,  $t(20) = 1.20, p > .05$ )

We are interested in finding whether the participants used CVS in generating positive examples. For this research, when the participants controlled two angles and changed the value of only one variable, we conclude that CVS is used. As you can see the result in Table 2, 88% participants appeared at least one CVS in the experiment. Actually, average CVS appearance was 3.3 times. And 76% participants generated at least one positive example by CVS. As a result, participants in this research used a higher rate of CVS when compared to the results of past studies.

CVS \ SPM	H	M	L	Total
Appearance	91	82	91	88
Generating positive examples	91	64	73	76

Table 2: Percentage of use CVS and generating examples for different SPM participants

On the other hand, this research also identified the formation of angles from FAS by the following methods: (1) compare trials of Angle 1, Angle 2 and Angle R with previous positive examples, and the absolute value of angle degrees differences in each column should be  $\leq 20$ . (2) the difference between two experiments in three angles matched one of the two conservatory relationship: (2-1) the absolute value of three angles' differences are the same, e.g., a previous positive example was 80, 60, 140 and a trial was 70, 50, 150, so the trial was adjusted by -10, -10, +10. (2-2) the sum or differences of the absolute value from two angle would be equivalent to the absolute value of the third angle degree differences, e.g., -10, 0, +10, or -10, +10, -20. (3) the trial was obtained from C6nt, not from CVS strategy or new rules. About 77% participants used FAS in at least two trials in the experiments. Participants with different SPM generated 6 experiments with FAS in average, and their rates of using FAS were 91%, 68%, and 73%.

## CONCLUSION AND DISCUSSION

Under self-directed discovery environment like InduLab, 50% fourth grade students could discover the properties of the angles of a triangle. Indulab provided not only a chance for discovering geometric properties, but also visualization, data table, sorting, and hiding tools for students. In order to find out the geometric properties about triangles, participants would first find enough positive examples. Even though literatures showed elementary school students performed poorly in using CVS (Chen & Klahr, 1999; Klahr, Fay, & Dunbar, 1993; Kuhn, Garcia-Mila, Zohar, & Anderson, 1995;) and the best rate of using CVS by fourth grade students was 48%, this research showed 80% participants with different SPM levels used CVS in the InduLab environment. When participants could not successfully form a triangle by setting Angle 1, Angle 2, and Angle R, which is Angle 3's complement, it would be easy to detect whether Angle R is too big or too small. At this moment, participants

would keep Angle 1 and Angle 2 unchanged, and only change Angle R in order to get a better triangle formation by CVS.

Moreover, this research found a new strategy called FAS which adjusted variables slightly from positive examples to generate a new trial. In this strategy, participants would have tacit knowledge in variables with conservatory relationship. This means students would not tell you the relations between Angle 2 and Angle R, but want to add the same value to both angles. The tacit knowledge may be invoked by the visualization of the geometric figures.

After generating a number of positive examples, the participants changed angles with wider degrees to evaluate their conjectures. In plausible reasoning, Polya (1954) mentioned the less similarity between the new evidence and the previous evidence, the more credible is the conjectures that are consistent with the new evidence. High SPM participants showed good performance in evaluating conjectures and this explained why there were greater variance in Angle 1 between the first and the last episode. Because Low SPM participants might not have formed any conjectures before the last episode, there was no different performance between two episodes. Angle 1 was the first angle set by participants and hence can reflect participants' different attempts in advance. And because Angle 2 were affected by Angle 1, the changes in degrees of Angle 1 would be greater than in Angle 2 in the last episode for Median SPM participants. This phenomenon revealed that different experiment data, which was provided by materials that are easy to manipulate in a computer-assisted learning environment, could enhance participants' confidence in evaluating conjectures.

There are two alternative explanations why the number of participants discovered the exterior angle property more than that for the interior angle property. First, a linear function involving three variables and no constant is easier than that involving three variables and one constant. Second, a function involving variables that can be set is much easier to be discovered than a function involving variables that cannot be set. With the former explanation, we can provide two types of variables, which can be put to use in the experiment, to make participants discover variables relationship and find out difficulties in different discoveries between simple functions and complicated functions in the future. With the latter explanation, participants represented: (1) variables which can be set showed figure-background perceptual phenomenon. For example, Angle 3 might be simply ignored because it can be derived from Angle R. (2) it was difficult to design the experiment when variables that cannot be set. For example, participants who found exterior angle property wanted to find another rule of forming triangle by examining the relationship of Angle 1, Angle 2, and Angle 3. However, they failed after generating ten positive examples because they did not know how to change Angle 3 indirectly by setting Angle R. Therefore, providing geometric variables that can be manipulated is important for participants to observe data, generate and evaluate conjectures in experiments on geometry and math.

## References

- Bruner, J. (1961). The act of discovery. *Harvard Educational Review*, 31, 21-32.
- Chen, Z., & Klahr, K. (1999). All other things being equal: Acquisition and transfer of the control of variables strategy. *Child Development*, 70, 1098-1120.
- Klahr, D., Fay, A., & Dunbar, K. (1993). Heuristics for scientific experimentation: A developmental study. *Cognitive Psychology*, 25, 111-146
- Kuhn, D., Garcia-Mila, M., Zohar, A., & Anderson, C. (1995). *Strategies of knowledge acquisition*. Monographs of the Society for Research in Child Development. serial no. 245. 60(40), 1-128.
- Polya, G. (1954). *Mathematics and plausible reasoning: Vol. I. Induction and analogy in mathematics*. Princeton, NJ: Princeton University Press.
- Steen, L. A. (1988). The science of patterns. *Science*, 240, 611-616
- Zimmerman, C. (2002). The development of scientific reasoning skills. *Developmental Review*, 20, 99-149.



# THE DISTRIBUTIONS OF VAN HIELE LEVELS OF GEOMETRIC THINKING AMONG 1<sup>ST</sup> THROUGH 6<sup>TH</sup> GRADERS

Der-bang Wu

Hsiu-lan Ma

National Tai-Chung University, Taiwan

Ling-Tung University, Taiwan

*This study presents partial results from the project “A Study of perceptual apprehensive, operative apprehensive, sequential apprehensive and discursive apprehensive for elementary school students (POSD)”, funded by National Science Council of Taiwan (NSCTW, Grant No. NSC92-2521-S-142-004). It was undertaken to explore the geometric concepts of the elementary school students at the first level of van Hiele’s geometric thought. The participants were 5,581 elementary school students, randomly selected from 23 counties/cities in Taiwan. The conclusions drawn from this study, for elementary school students, were: (a) evidence supporting the hierarchy of the van Hiele levels, (b) students at different levels for different concepts of basic figures, and (c) cases of students did not reach visual level of basic figures.*

## INTRODUCTION

Geometry is one of the most important topics in mathematics (Ministry of Education of Taiwan (MET), 1993, 2000, 2003; National Council of Teachers of Mathematics (NCTM), 1989, 1991, 1995, 2000). Geometry curriculum is developed and designed according to the van Hiele model of geometric thought in Taiwan (MET, 1993, 2000, 2003).

In 1957, the van Hiele model was developed by two Dutch mathematics educators, P. M. van Hiele, and his wife (van Hiele, 1957). Several studies have been conducted to discover the implications of the theory for current K-12 geometry curricula, and to validate aspects of the van Hiele model (Burger & Shaughnessy, 1986a; Eberle, 1989; Fuys, Geddes, & Tischler, 1988; Gutierrez, Jaime, & Fortuny, 1991; Ma & Wu, 2000; Mayberry, 1983; Molina, 1990; Senk, 1983; Pegg, 1985; Pegg & Davey, 1989, 1991; Usiskin, 1982; Wu, 1994, 1995, 2003; Wu & Ma, 2005a, 2005b). Besides the researches of Wu & Ma (2005a, 2005b), most of researchers focus on the geometry curricula of secondary school. To discover the implications of the van Hiele theory for elementary school students, however, it is also very important. The focus of this study is at the elementary level. This research report is one of the six sessions from the project “A Study of perceptual apprehensive, operative apprehensive, sequential apprehensive and discursive apprehensive for elementary school students (POSD)”, funded by National Science Council of Taiwan (NSCTW, Grant No. NSC92-2521-S-142-004).

The main objectives of this study were to determine the distributions of van Hiele levels of geometric thinking among 1<sup>st</sup> through 6<sup>th</sup> graders.

## THEORETICAL FRAMEWORK

There are five levels of the van Hiele's geometric thought: "visual", "descriptive", "theoretical", "formal logic", and "the nature of logical laws" (van Hiele, 1986, p. 53). These five levels have two been labelled in two different ways: Level 1 through Level 5 or below level 1 through Level 4. Researchers have not yet come to a conclusion of which one to use. In this study, these five levels were called Level 1 through Level 5, and the focus of this study was on Level 1, visual.

At level 1, students learned the geometry through visualization. According to van Hiele (1986), "Figures are judged by their appearance. A child recognizes a rectangle by its form and a rectangle seems different to him than a square (p. 245)." At this first level students identify and operate on shapes (e.g., squares, triangles, etc.) and other geometric parts (e.g., lines, angles, grids, etc.) based on the appearance.

[At the second level,] figures are bearers of their properties. That a figure is a rectangle means that it has four right angles, diagonals are equal, and opposite sides are equal. Figures are recognized by their properties. If one tells us that the figure drawn on a blackboard has four right angles, it is a rectangle even if the figure is drawn badly. But at this level properties are not yet ordered, so that a square is not necessarily identified as being a rectangle. (van Hiele, 1984b, p. 245)

[At the third level,] Properties are ordered. They are deduced one from another: one property precedes or follows another property. At this level the intrinsic meaning of deduction is not understood by the students. The square is recognized as being a rectangle because at this level definitions of figure come into play. (van Hiele, 1984b, p. 245)

Mayberry (1983) designed an oral instrument to investigate pre-service teachers' levels of reasoning. She found (a) evidence supporting the hierarchy of the van Hiele levels, (b) students at different levels for different concepts, and (c) cases of students did not reach level 1 (visual) reasoning skills. The focuses of this study were the elementary school students and first three van Hiele levels, to explore what kind of the results comparing with Mayberry's research.

## METHODS AND PROCEDURES

### Participants

The participants were 5,581 elementary school students who were randomly selected from 25 elementary schools in 23 counties/cities in Taiwan. There were 2,717 girls and 2,864 boys. The numbers of participants, from 1<sup>st</sup> to 6<sup>th</sup> grades, were 910, 912, 917, 909, 920, 1,013 students, respectively.

### Instrument

The instrument used in this study, Wu's Geometry Test (WGT), was specifically designed for this project due to there were no suitable Chinese instruments available. This instrument was designed base on van Hiele level descriptors and sample responses identified by Fuys, Geddes, and Tischler (1988). There were 25 multiple-

choice questions of the first van Hiele level; 20 in the second and 25 in the third. The test is focus on three basic geometric figures: triangle, quadrilateral and circle.

The scoring criteria were based on the van Hiele Geometry Test (VHG), developed by Usiskin (1982), in the project “van Hiele Levels and Achievement in Secondary School Geometry” (CDASSG Project). In the VHG test, each level has five questions. If the student answers three, four, or five the first level questions correctly, he/she has reached the first level. If the students (a) answered three questions or more correctly from the second level; (b) met the criteria of the first level; and (c) did not correctly answer three or more questions, from levels 3, 4, and 5, they were classified as in second level. Therefore, using the same criteria set by Usiskin (1982), the passing rate of this study was set at 60%. If the scores of the students did not follow the criteria, the cases were labelled “jump phenomenon” by the authors.

### Validity and Reliability of the Instrument

The attempt to validate the instrument (WGT) involved the critiques of a validating team. The members of this team included elementary school teachers, graduate students majored in mathematics education, and professors from Mathematics Education Departments at several pre-service teacher preparation institutes. The team members were given this instrument, and provide feedback regarding whether each test item was suitable. They also gave suggestions about how to make this test better.

In order to measure the reliability of the WGT, 289 elementary school students ( from grades 1-6) were selected to take the WGT. These students were not participants in this study. The alpha reliability coefficient of the first van Hiele level of WGT was .67 ( $p < .001$ ), 0.88 ( $p < .01$ ) level 2, and 0.94 ( $p < .01$ ) level 3, using SPSS<sup>®</sup> for Windows<sup>®</sup> Version 10.0.

### Procedure

The one-time WGT was given to 1<sup>st</sup> to 6<sup>th</sup> graders during April 2004. The class teachers of the participants administered the test in one mathematics class. The answers were graded by the project directors.

The distribution of the questions is in Table 1.

	Number of the questions
van Hiele level 1	Q 1 to Q25
van Hiele level 2	Q26 to Q45
van Hiele level 3	Q46 to Q70

Table 1: The distribution of questions in level 1 to 3

## RESULTS

### Overall performance on basic figures

Based on the questions of triangle, 43.0% of the elementary school students were at van Hiele level 1, 28.0% at level 2, and 5.2% at Level 3. The students who were at level 1 of questions of quadrilateral were 25.9%, 28.0% at level 2, and 5.5% at level 3. For the questions of circle, 35.7% of the elementary school students were at van Hiele level 1, 45.5% at level 2, and 7.7% at level 3 (See Table 2).

The percentage of students did NOT meet the criteria of level 1 (below level 1), for the triangle were 20.8%, 30.3% for quadrilateral, and 7.7% for circle. It seemed that the circle concept is the easiest one for students, followed by triangle concept, and quadrilateral concept. It was worth to mention that the percentage of students appeared “jump phenomenon”, for the triangle were 2.9%, 10.3% for quadrilateral, and 3.3% for circle.

	Triangle		Quadrilateral		Circle	
	Frequency	Percent	Frequency	Percent	Frequency	Percent
Below level 1	1163	20.8	1691	30.3	431	7.7
Level 1	2402	43.0	1447	25.9	1995	35.7
Level 2	1561	28.0	1563	28.0	2538	45.5
Level 3	293	5.2	305	5.5	432	7.7
Jump	162	2.9	575	10.3	185	3.3
Total	5581	100.0	5581	100.0	5581	100.0

Table 2: The overall distributions of levels 1 to 3

### The distributions of van Hiele levels of Triangle Concepts

		Triangle				Total
		Below level 1	Level 1	Level 2	Level 3	
Grade 1	Count	472	438	0	0	910
	% within Grade	51.9%	48.1%	.0%	.0%	100.0%
Grade 2	Count	341	571	0	0	912
	% within Grade	37.4%	62.6%	.0%	.0%	100.0%
Grade 3	Count	151	494	239	0	884
	% within Grade	17.1%	55.9%	27.0%	.0%	100.0%
Grade 4	Count	78	448	359	0	885
	% within Grade	8.8%	50.6%	40.6%	.0%	100.0%
Grade 5	Count	68	262	449	96	875
	% within Grade	7.8%	29.9%	51.3%	11.0%	100.0%
Grade 6	Count	53	189	514	197	953
	% within Grade	5.6%	19.8%	53.9%	20.7%	100.0%
Total	Count	1163	2402	1561	293	5419
	% within Grade	21.5%	44.3%	28.8%	5.4%	100.0%

Table 3: The percentage analyzed by grades and levels based on triangle

The percentage of students appeared “jump phenomenon”, for the triangle were 2.9% (See Table2). Thus, there were 5,419 (97.1%) students who could be assigned to levels 1 to 3. The distributions of van Hiele level of triangle concepts from grades 1 to 6 of each figure were shown as Table 3.

Based on the questions of triangle, 48.1% of the grades 1 were at van Hiele level 1, 62.6% grade 2. The grades 3 were at level 1 of the triangle concept were 55.9%, 27.0% at level 2. The grades 4 were at level 1 of the triangle concept were 50.6%, 40.6% at level 2. The grades 5 were at level 1 of the triangle concept were 29.9%, 51.3% at level 2, and 11.0% at level 3. The grades 6 who were assigned at level 1 of the triangle concept were 19.8%, 53.9% at level 2, and 20.7% at level 3 (See Table 3).

### The distributions of van Hiele levels of Quadrilateral Concepts

The percentage of students appeared “jump phenomenon”, for the quadrilateral were 10.3% (See Table2). Thus, there were 5,006 (89.7%) students who could be assigned to levels 1 to 3. The distributions of van Hiele level of quadrilateral concepts from grades 1 to 6 of each figure were shown as Table 4.

		Quadrilateral				Total
		Below level 1	Level 1	Level 2	Level 3	
Grade 1	Count	627	283	0	0	910
	% within Grade	68.9%	31.1%	.0%	.0%	100.0%
2	Count	488	424	0	0	912
	% within Grade	53.5%	46.5%	.0%	.0%	100.0%
3	Count	288	330	225	0	843
	% within Grade	34.2%	39.1%	26.7%	.0%	100.0%
4	Count	127	263	443	0	833
	% within Grade	15.2%	31.6%	53.2%	.0%	100.0%
5	Count	86	84	441	113	724
	% within Grade	11.9%	11.6%	60.9%	15.6%	100.0%
6	Count	75	63	454	192	784
	% within Grade	9.6%	8.0%	57.9%	24.5%	100.0%
Total	Count	1691	1447	1563	305	5006
	% within Grade	33.8%	28.9%	31.2%	6.1%	100.0%

Table 4: The percentage analyzed by grades and levels based on quadrilateral

Based on the questions of quadrilateral, 31.1% of the grades 1 were at van Hiele level 1, 46.5% grade 2. The grades 3 were at level 1 of the quadrilateral concept were 39.1%, 26.7% at level 2. The grades 4 were at level 1 of the quadrilateral concept were 31.6%, 53.2% at level 2. The grades 5 were at level 1 of the quadrilateral concept were 5.8%, 28.2% at level 2, and 37.0% at level 3. The grades 6 who were assigned at level 1 of the quadrilateral concept were 8.0%, 57.9% at level 2, and 24.5% at level 3 (See Table 4).

### The distributions of van Hiele levels of Circle Concepts

The percentage of students appeared “jump phenomenon”, for the circle were 3.3% (See Table2). Thus, there were 5,396 (96.7%) students who were at levels 1 through 3. The distributions of van Hiele level of circle concepts from grades 1 to 6 of each figure were shown as Table 5.

		Circle				Total
		Below level 1	Level 1	Level 2	Level 3	
Grade 1	Count	220	690	0	0	910
	% within Grade	24.2%	75.8%	.0%	.0%	100.0%
Grade 2	Count	97	815	0	0	912
	% within Grade	10.6%	89.4%	.0%	.0%	100.0%
Grade 3	Count	58	285	546	1	890
	% within Grade	6.5%	32.0%	61.3%	.1%	100.0%
Grade 4	Count	20	132	717	2	871
	% within Grade	2.3%	15.2%	82.3%	.2%	100.0%
Grade 5	Count	22	35	644	159	860
	% within Grade	2.6%	4.1%	74.9%	18.5%	100.0%
Grade 6	Count	14	38	631	270	953
	% within Grade	1.5%	4.0%	66.2%	28.3%	100.0%
Total	Count	431	1995	2538	432	5396
	% within Grade	8.0%	37.0%	47.0%	8.0%	100.0%

Table 5: The percentage analyzed by grades and levels based on cycle

Based on the questions of circle, 75.8% of the grades 1 were at van Hiele level 1, 89.4% grade 2. The grades 3 were at level 1 of the circle concept were 32.0%, 61.3% at level 2, and 0.1% at level 3. The grades 4 were at level 1 of the circle concept were 15.2%, 82.3% at level 2, and 0.2% at level 3. The grades 5 were at level 1 of the circle concept were 4.1%, 74.9% at level 2, and 18.5% at level 3. The grades 6 who were assigned at level 1 of the circle concept were 4.0%, 66.2% at level 2, and 28.3% at level 3 (See Table 5).

## CONCLUSION:

More than half of (up to 51.9%) graders 1 did NOT met the criteria of the first level (below level 1) based on the triangle, 68.9% on quadrilateral, and 24.2% on circle. It seems that the circular concept is the easiest for students; on the other hand, the concept of quadrilateral is the most difficult to students. This result consisted with the research of Wu & Ma (2005a).

The results of this study found that the higher grades get the higher van Hiele levels. Based on the questions of triangle and quadrilateral, no students of graders 1 to 4 were at level 3 and no grades 1 to 2 were at level 2. Based on these three basic figures (triangle, quadrilateral, circle), most of grades 1 to 2 were at level 1, and grades 3 to 6 were at level 2. Only grade 5 and 6 could meet the level 3.

Comparing with Mayberry's (1983) research, this study found, for elementary school students, (a) evidence supporting the hierarchy of the van Hiele levels, (b) students at different levels for different concepts of basic figures, and (c) cases of students did not reach level 1 of basic figures.

The results of this study identified the easiest and the most difficult concepts of basic figures for students, it is important to investigate the reason(s) behind this result. The authors of this study are interested to investigate why elementary students have difficulties in quadrilateral. One reason might be that quadrilaterals, except squares

and rectangle, are rarely shown in the textbook of grade 1, and in their daily lives. Researchers might consider this as their research interests.

**Acknowledgements:** The research reported in this paper was supported by the National Science Council of Taiwan under Grant No. NSC92-2521-S-142-004. Any opinions, viewpoints, findings, conclusions, suggests, or recommendations expressed are the authors and do not necessarily reflect the views of the National Science Council, Taiwan.

The investigators of this research appreciate Dr. Kai-ju Hsieh, a co-worker of Dr. Der-bang Wu, who reviewed and helped to correct this paper.

## References

- Burger, W. F., & Shaughnessy, J. M. (1986a). *Assessing children's intellectual growth in geometry* (Final report of the Assessing Children's Intellectual Growth in Geometry project). Corvallis, OR: Oregon State University, Department of Mathematics.
- Clements, D. H., & Battista, M. T. (1992). Geometry and spatial Reasoning. In D. A. Grouws (Ed.), *Handbook of research on mathematics teaching and learning* (pp. 420-464). Reston, VA: National Council of Teachers of Mathematics.
- Eberle, R. S. (1989). *The effects of instruction on the van Hiele levels of geometric reasoning in preservice elementary teachers*. Unpublished master's thesis, The University of Texas at Austin.
- Fuys, D., Geddes, D., & Tischler, R. (1988). *The van Hiele model of thinking in geometry among adolescents*. Reston, VA: National Council of Teachers of Mathematics, Inc.
- Gutierrez, A., Jaime, D., & Fortuny, J. M. (1991). An alternative paradigm to evaluate the acquisition of the van Hiele levels. *Journal for Research in Mathematics Education*, 22(3), 237-251.
- Ma, H. L. & Wu, D. B. (2000). An Introduction to the van Hiele Model of Geometric Thought. *Journal of Ling-Tung College*, 11, 289-310.
- Mayberry, J. W. (1983). The van Hiele levels of geometric thought in undergraduate preservice teachers. *Journal for Research in Mathematics Education*, 14(1), 58-69.
- Ministry of Education of Taiwan (MET) (1993). *Curriculum standards for national elementary school in Taiwan*. Taipei, Taiwan: The Author. (In Chinese)
- Ministry of Education of Taiwan (MET) (2000). *Grade 1-9 Curriculum Provisional Guidelines—Mathematics*. Taipei, Taiwan: The Author. (In Chinese)
- Ministry of Education of Taiwan (MET) (2003). *Grade 1-9 Curriculum Guidelines—Mathematics*. Taipei, Taiwan: Author. (In Chinese)
- Molina, D. D. (1990). *The applicability of the van Hiele theory to transformational geometry*. Unpublished doctoral dissertation, The University of Texas at Austin.
- Senk, S. L. (1983). Proof writing achievement and van Hiele levels among secondary school geometry students (Doctoral Dissertation, The University of Chicago, 1983). *Dissertation Abstracts International*, 44, 417A.
- National Council of Teachers of Mathematics (NCTM) (1989). *Curriculum and evaluation standards for school mathematics*. Reston, VA.: Author.

- National Council of Teachers of Mathematics (NCTM) (1991). *Professional standards for teaching mathematics*. Reston, VA: Author.
- National Council of Teachers of Mathematics (NCTM) (1995). *Assessment standards for school mathematics*. Reston, VA: Author.
- National Council of Teachers of Mathematics (NCTM) (2000). *Curriculum and evaluation standards for school mathematics*. Reston, VA: Author.
- Pegg, J. (1985). How children learn geometry: The van Hiele model. *Australian Mathematics Teacher*, 41(2), 2-4.
- Pegg, J., & Davey, G. (1989). Clarifying level descriptors for children's understanding of some basic 2-D geometry shapes. *Mathematics Education Research Journal*, 1(1), 16-27.
- Pegg, J., & Davey, G. (1991). Levels of geometric understanding. *Australian Mathematics Teacher*, 47(2), 10-13.
- Usiskin, Z. P. (1982). *van Hiele levels and achievement in secondary school geometry* (Final Report of the Cognitive Development and Achievement in Secondary School Geometry Project). Chicago, IL: University of Chicago, Department of Education. (ERIC Reproduction Service No. ED 220 288).
- Van Hiele, P. M. (1986). *Structure and insight: A theory of mathematics education*. Orlando, FL: Academic Press.
- Wu, D. B. (1994). *A study of the use of the van Hiele model in the teaching of non-Euclidean geometry to prospective elementary school teachers in Taiwan, the Republic of China*. Unpublished Doctoral dissertation, University of Northern Colorado, Greeley.
- Wu, D. B. (1995). A study of the use of the van Hiele model in the teaching of non-Euclidean geometry to prospective elementary school teachers in Taiwan, the Republic of China. *Journal of National Taichung Teachers College*, 9, 443-474.
- Wu, D. B. (2003). *A study of perceptual apprehensive, operative apprehensive, sequential apprehensive and discursive apprehensive for elementary school students* (Final Report of the A study perceptual apprehensive, operative apprehensive, sequential apprehensive and discursive apprehensive for elementary school students Project). Taichung, Taiwan: National Taichung Teachers College, Department of Mathematics Education. (National Science Council under Grant No. NSC91-2521-S-142-004. In Chinese).
- Wu, D. B., Ma, H. L. (2005a). A study of the geometric concepts of the elementary school students at the van Hiele level one. In Chick, H. L. & Vincent, J. L. (Eds.). *Proceedings 29th Conference of the International Group for the Psychology of Mathematics Education, Vol. 4*, pp. 329-336. Melbourne, Australia: PME.
- Wu, D. B., Ma, H. L. (2005b). *A study of the developing procedure of the van Hiele geometry test for elementary school students*. Paper presented in The Third East Asia Regional Conference on Mathematics Education (ICMI Regional Conference). 7 Aug. – 12 Aug., 2005. Shanghai, Nanjing, and Hangzhou China.



# ELEMENTARY TEACHER EDUCATION AND TEACHER EFFICACY TOWARD MATHEMATICS AND SCIENCE

Wu, S. C.

Chang, Y. L.

National Chiayi University

MingDao University

*Elementary teacher education in Taiwan has been facing the dilemma of cultivating prospective teachers to be generalists or specialists for certain subject areas since 1997. Referring to the significant factors affecting teacher education, “teacher efficacy” deserves to be in the heart of this dilemmatic evolution. This study aimed to compare prospective teachers’ efficacy toward mathematics and science of ten preparation programs. Findings indicated that the more subject-matter preparations the superior efficacy was established. It further provided a deliberation on how to prepare elementary teachers.*

## INTRODUCTION

A large and growing body of research data indicate that the preparation and ongoing professional development of teachers in mathematics and science for grades K-12 needs rethinking and improvement on a large scale (e.g., Holmes Group, 1995; Hwang, 2003; National Research Council [NRC], 2001; National Science Foundation, 1996; Rodriguez, 1998; Sanders & Rivers, 1996; Wright et al., 1997; Wu, 2004). While re-examining the effectiveness of the design of teacher preparation programs, it indicates that the traditional design of teacher preparation programs are oriented in cultivating elementary generalists (NRC, 2001). Furthermore, for instance, “too often, teacher preparation programs are characterized by a lack of coherence and articulation across the general education, science education, and professional education curriculum strands” (NRC, 1997, p. 9). Even though most programs currently require prospective elementary school teachers to have a major in a discipline other than education, few of them choose majors in mathematics or science. Within this trend of program designing, prospective teachers received inadequate preparation in certain subject areas, for instance, mathematics and science (education). It led to the insufficiency of in-depth content knowledge and conceptual understanding of and efficacy toward mathematics and science needed for teaching these subjects effectively at all grades.

With regard to Taiwan, the design of all teacher preparation programs encountered significant changes beginning in 1997. Perspective teachers who entered the teachers college were categorized into different departments (programs), such as Departments of Mathematics Education for students’ major in mathematics education. Usually, there were eleven departments in one teachers college<sup>1</sup>, including Departments of Mathematics Education (DME), Science Education (DSE), Elementary Education (DEE), Language Education (DLE), Art Education (DAE), Social Science Education (DSS), Music Education (DMU), Early Childhood Education (DEC), Special

2006. In Novotná, J., Moraová, H., Krátká, M. & Stehlíková, N. (Eds.). *Proceedings 30<sup>th</sup> Conference of the International Group for the Psychology of Mathematics Education*, Vol. 5, pp. 417-424. Prague: PME. 5 - 417

Education (DSP), Physical Education (DPE), and Department of Children's English Education (DCE). The purpose of separating the whole teacher preparation system by subject matter was to train all prospective teachers to be not only generalists but also specialists in certain subject areas. Following this movement, the teacher preparation programs were modified by having more detailed separation of functions enabling all new teachers to master the subject matter they would teach in the classroom. In addition, there were several new departments established, e.g. DSP and DCE, as well as many graduate schools of education in various subject areas or for diverse purposes. All of these efforts in restructuring the teacher preparation programs were to ensure that there would be well-qualified teachers who had different specialties in every elementary school. This idea just confirmed the previous recommendation (Romberg, 1994) from participants at a 1993 conference sponsored by the U.S. Department of Education, the NCTM, and the Wisconsin Center for Education Research.

However, there are ongoing innovative projects of the teacher education system in Taiwan, e.g. named as "New Regulations of Teacher Education" (Ministry of Education [MOE], Taiwan, 1999), "The Incorporation of Public Universities and Colleges" (MOE, Taiwan, 2002), and "2004 Education in Republic of China" (MOE, Taiwan, 2004). In this movement, teachers colleges are promoted alone or incorporated with other public colleges to become universities of education or comprehensive universities. The teacher preparation program design within these universities is changed again in order to align to the worldwide trend of reconstructing the higher education system, such as reforms in Australia, Netherlands, England, Germany, Japan, the United States, and so forth (MOE, Taiwan, 2002). Programs are oriented to train generalists because of two major strategies of "merging" and "reorienting". In "merging", Department of Education (DE) and DEC are the main programs for training elementary prospective teachers. As mentioned above, this kind of program design will result in inadequate preparations for some major subject areas, e.g. mathematics and science, in the elementary level. In "reorienting", DME is renamed as Department of Applied Mathematics, which emphasizes more in applied mathematics but rather mathematics education. Nevertheless, there will be more mathematicians prepared by this program but rather qualified elementary mathematics teachers, which is still the key issue in this maelstrom of the education debate.

### **Teacher efficacy and teacher quality**

The concept of teacher's sense of efficacy has gained much attention in recent years (Pajares, 1992). "Beginning with research in the 1970s (e.g., Armor et al., 1976; Berman et al., 1977), teacher efficacy was first conceptualized as teachers' general capacity to influence student performance" (Allinder, 1995, p.247). Since then, the concept of teacher's sense of efficacy has developed continuously and currently is discussed relevant to Albert Bandura's (1977) theory of self-efficacy, which indicates the significance of teachers' beliefs in their own capabilities in relation to the effects of student learning and achievement. The self-efficacy construct described by

Bandura was composed of two cognitive dimensions, personal self-efficacy and outcome expectancy. Bandura (1977) defined personal self-efficacy (i.e. efficacy expectation) as “the conviction that one can successfully execute the behavior required to produce the outcomes” and outcome expectancy as “a person’s estimate that a given behavior will lead to certain outcomes” (p. 193).

Several studies further reported, “Teacher efficacy has been identified as a variable accounting for individual differences in teaching effectiveness” (Gibson & Dembo, 1984, p. 569) and had a strong relationship with student learning and achievement (Allinder, 1995; Gibson & Dembo, 1984; Madison, 1997). Berman et al. (1977) reported that teacher efficacy had the strongest relationships with the student gain in learning, with a standardized regression coefficient of .21 for sense of efficacy with improvement in student achievement as the dependent variable (Denham & Michael, 1981). Later, Allinder (1995) concluded, “Teachers with high personal efficacy and high teaching efficacy increased end-of-year goals more often for their students ... Teachers with high personal efficacy effected significantly greater growth” (p. 247).

### **Teacher education and teacher efficacy**

Accordingly, which kind of design is better for preparing elementary prospective teachers, especially for certain subject areas, one program for the generalists or several separated programs for teachers with variety of majors? It will be definitely a dilemma within this teacher education reform in both Taiwan and countries worldwide. How to discover the appropriate practice for designing programs of training elementary teachers will be also the core in this educational action plan.

With regard to factors affecting the teacher preparation, a statement in Ashton’s (1984) study addressed the significance of “teacher’s sense of efficacy” to teacher education:

A powerful paradigm for teacher education can be developed on the basis of the construct of teacher efficacy. Ashton asserts that no other teacher characteristic has demonstrated such a consistent relationship to student achievement. A teacher education program that has as its aim the development of teacher efficacy, and which includes the essential components of a motivation change program, should develop teachers who possess the motivation essential for effective classroom performance (p. 28).

Benz et al. (1992) further recommended, “Helping pre-service teachers to construct beliefs that most positively effect their decision-making in the classroom is an important effort in teacher education reform” (p. 284). Accordingly, a comparative examination of the teacher efficacy as the factor of the effectiveness of teacher preparation programs may help to clarify elements for improving teacher quality as well as remodelling teacher preparation programs.

### **PURPOSE AND METHOD**

The main purpose of this study was to investigate the effectiveness of elementary teacher preparation program designs by examining perspective teachers’ efficacy toward mathematics and science among targeted students. Further, the relationship

in the sense of efficacy toward mathematics and science among all participants was also explored. Altogether, there were ten different programs within the participating college, a national teachers college located at the central part of Taiwan, and 340 participants totally. A quasi-experimental research design with pre- and post-tests was applied in this study. Two standardized instruments, i.e. Mathematics Teaching Efficacy Beliefs Instruments for pre-service teachers (MTEBI, Enochs, Smith, & Huinker, 2000) and Science Teaching Efficacy Beliefs Instruments for pre-service teachers (STEBI, Enochs & Riggs, 1990), and a Participant Main Survey were applied to ascertain the outcomes of pre-service teachers' sense of efficacy toward mathematics and science and compare the differences among these ten different programs. These three instruments were first administered to these 340 freshmen (the first year of entering the programs) as a pre-test. Then, these instruments were administered again to the same students (as seniors at the fourth year) as a post-test. Data were collected, entered, and reorganized right after receiving. Descriptive and inferential statistical analyses (i.e. ANCOVA) were applied in this study associated with a detailed documentation analysis of the curriculum structure and course works.

## FINDING AND DISCUSSION

Both of pre-service teachers' sense of efficacy toward mathematics and science found in this study were significantly different among these ten programs. According to the findings of the study, students in DME had a superior rating in the cognitive dimension of Personal Mathematics Teaching Efficacy (PMTE), while students in DSE scored higher in Personal Science Teaching Efficacy (PSTE). After receiving four-year training, both groups of students (i.e. DME and DSE) had more confidence in their own teaching abilities than other students who did not specialize in either mathematics or science (i.e. remained eight programs<sup>2</sup>), shown as table 1. However, considering the highest mean scores of PMTE and PSTE, DME and DSE students only had approximately 74 percent of confidence in their own teaching abilities. This information provides another warning for all teacher preparation programs: If these pre-service teachers believed they were not ready to assume the teaching responsibility, i.e. they have low confidence in their future teaching ability, teaching quality is potentially jeopardized. Therefore, how to increase the confidence level of these prospective teachers for future teaching is an additional issue and task for teacher preparation programs.

Program	DME	DSE	DEE	DLE	DAE	DSS	DMU	DEC	DSP	DPE
PMTE	48.79	46.97	43.88	41.74	43.50	42.97	40.47	42.56	42.68	42.38
<i>SD</i>	3.179	5.363	5.830	7.085	5.733	3.520	5.915	4.737	5.050	4.278
PSTE	46.09	57.32	46.68	44.21	46.62	41.68	43.24	43.38	45.24	45.41
<i>SD</i>	5.627	7.388	9.644	5.793	6.818	6.834	8.268	9.293	7.878	4.762

Table 1: Mean Scores (and *SD*) of PMTE and PSTE in the Post-test

Another finding showed that students in DME had a significantly superior rating in the cognitive dimension of Mathematics Teaching Outcome Expectancy (MTOE), while students in DSE scored higher in Science Teaching Outcome Expectancy (STOE) but no significance, shown as table 2. Data indicated that all students (prospective teachers) had a range from 60 to 80 percent belief that students' learning can be influenced by effective teaching. However, as indicated above, they did not have adequate confidence in providing efficient teaching in the classroom. Thus, even though they believed effective teaching was essential for students' learning and achievement, the quality of teaching and learning could still not be guaranteed. As Gibson and Dembo (1984) stated, teachers with high efficacy should "persist longer, provide a greater academic focus in the classroom, and exhibit different types of feedback than teachers' who have lower expectations concerning their ability to influence student learning" (p.570). Teacher preparation programs need to discover ways to improve the ratings of both personal teaching efficacy and teaching outcome expectancy of their pre-service teachers in order to improve the quality of teaching and learning in all elementary classrooms.

Program	DME	DSE	DEE	DLE	DAE	DSS	DMU	DEC	DSP	DPE
MTOE	32.09	27.76	28.09	26.24	27.79	27.29	28.00	28.12	27.44	27.74
<i>SD</i>	2.515	4.171	3.671	4.286	2.952	2.541	4.097	3.506	3.526	4.287
STOE	39.41	39.65	40.32	38.03	37.59	38.44	38.74	38.06	38.56	37.09
<i>SD</i>	4.046	6.545	6.034	5.248	4.432	3.145	4.882	4.832	4.134	5.294

Table 2: Mean Scores (and *SD*) of MTOE and STOE in the Post-test

Correlations coefficients were computed among the three scores of each category, i.e. Mathematics Total Score, Science Total Score, PMTE, MTOE, PSTE, and STOE in the post-test. Significant correlation was found between teachers' sense of efficacy toward mathematics and science (i.e. total score). Data also indicated that there were statistically significant relationship between PMTE and PSTE, MTOE and STOE, PMTE and MTOE, and PSTE and STOE. This valuable information provides teacher preparation programs with sufficient reason to devote attention to establishing their prospective teachers' confidence by increasing the connections between the preparations of mathematics and science. Additionally, they may also endeavor to make more efforts on assisting these pre-service teachers to build up both their personal teaching efficacy and teaching outcome expectancy simultaneously.

A detailed document review was conducted to compare the differences of the curriculum structure and course works among these ten programs before and during the formal study. Since the main purpose of this study was to examine perspective teachers' efficacy toward mathematics and science, DME and DSE programs were reported separately for showing the desired model of program design. Also because of the similarity of remained eight programs, their curriculum structures were reported together, while only the DEE program was explained as an example of not specializing in either mathematics or science. With regard to the number of general

content knowledge courses and methods courses taken in mathematics and science, students in DME and DSE received more preparations in content knowledge and teaching methodology, a total of 77 or more required credits for both programs, shown as table 3. Students in other 8 programs (departments) took only 22 or more and 25 required credits respectively in the disciplines of mathematics and science.

Program	CC (M & S) <sup>a</sup>	GKC (M & S)	ESFC (Me) <sup>b</sup>	MC	Total
DME	10 (2-3)	57 (15)	30 (9)	51 (M)	148
DSE	10 (2-3)	57 (15)	30 (9)	51 (S)	148
Other 8 programs	14 (3-4)	48 (10)	20 (9)	66 (EE) <sup>c</sup>	148

a. "M & S" indicates common courses or general knowledge courses related to mathematics and sciences.

b. "Me" refers to elementary mathematics and science methods courses.

c. "EE" indicates common courses or general knowledge courses related to elementary education in DEE program, as an example.

Table 3: Curriculum Structure Comparisons (Credit Hours)

The traditional design of teacher preparation programs, which are oriented in cultivating elementary generalists (NRC, 2001), will be inadequate for accomplishing the requirement of having qualified teachers in every classroom and for every subject area. As students have diverse needs and distinct characteristics, it is truly essential that specialized teachers exist for every subject area in every school. In order to reach the goal of enhancing prospective teachers' sense of efficacy toward mathematics and science, including both personal teaching efficacy and teaching outcome expectancy, teacher preparation programs and their faculty members should rethink the program design, the curriculum structure, the content provided, and the pedagogy used in preparing them to teach mathematics and science. Further, even though more preparations in these two subject areas are no guarantee of higher quality of pre-service teachers and their better understandings of their subjects, insufficient preparation will definitely result in inadequacy of content and pedagogical knowledge and teaching skills in mathematics and science. This inadequacy will surely have a great influence on the quality of future teachers and the performance of their students (Chang, Wu, & Gentry, 2005).

## CONCLUSION

According to the findings of this study, the teacher preparation program design did play a significant role in preparing future teachers in mathematics and science for the elementary school. Referring to how to make progress in improving the quality of elementary mathematics and science teachers, the program designs of DME and DSE of the participating teachers college in Taiwan demonstrated both more extensive curriculum frameworks in preparing prospective teachers' subject matter knowledge and more self-confidence in delivering effective teaching in the classroom. While Taiwan's teacher education system is trying to pursue a more organized restructuring

system for elementary teacher preparation in the current evolution, is it the right time to rethink and react for the purpose of advancing a new elementary teacher education component, especially for mathematics and science education?

### Endnotes

- <sup>1</sup> Number of programs (departments) varied in every teacher college. There were 9 teachers colleges totally in Taiwan in the year of 1997.
- <sup>2</sup> Remaining 8 programs from DEE, DLE, DAE, DSS, DMU, DEC, DSP, and DPE in the participating teachers college.

**Acknowledgement** One part of this research was funded by the National Science Council (NSC) of Taiwan, numbered as “NSC 93-2511-S-451-001”. An ongoing research project will provide in-depth information qualitatively of how to improve teacher efficacy in PME 31.

### References

- Allinder, R.M. (1995). An examination of the relationship between teacher efficacy and curriculum-based measurement and student achievement. *Remedial and Special Education, 16* (4), 247-254.
- Armor, D., Conroy-Osequera, P., Cox, M., King, N., McDonnell, L., Pascal, A., Pauley, E., & Zellman, G. (1976). *Analysis of the school preferred reading programs in selected Los Angeles minority schools*. (R-2007-LAUSD). Santa Monica, CA: Rand Corp.
- Ashton, P. (1984). Teacher efficacy: A motivational paradigm for effective teacher education. *Journal of Teacher Education, 35* (5), 28-32.
- Bandura, A. (1977). Self-efficacy: toward a unifying theory of behavioral change. *Psychological Review, 84*(2), 191-215.
- Benz, C.R., Bradley, L., Alderman, M.K., & Flowers, M.A. (1992). Personal teaching efficacy: Developmental relationships in education. *Journal of Educational Research, 85* (5), 274-285.
- Berman, P., McLaughlin, M., Bass, G., Pauly, E., & Zellman, G. (1977). *Federal programs supporting educational change (Vol. 7): Factors affecting implementation and continuation*. Santa Monica, CA: The Rand Corporation.
- Chang, Y. L., Wu, S. C., & Gentry, N. D. (2005). Is it time to advance a new science teacher education component? Comparative study on program design and knowledge assessment. *Proceedings of the 3rd Hawaii International Conference on Education*, pp. 612-645, Honolulu, HI, U.S.A.
- Enochs, L.G., & Riggs, I.M. (1990). Further development of an elementary science teaching efficacy belief instrument: A preservice elementary scale. *School Science and Mathematics, 90* (8), 694-706.
- Enochs, L.G., Smith, P.L., & Huinker, D. (2000). Establishing factorial validity of the mathematics teaching efficacy beliefs instrument. *School Science and Mathematics, 100* (4), 194-201.
- Gibson, S. & Dembo, M. H. (1984). Teacher efficacy: A construct validation. *Journal of Educational Psychology, 76*(4), 569-582.

- Holmes Group (1995). *Tomorrow's school of education*. East Lansing, MI: The Holmes Group.
- Hwang, S. L. (2003). "Blind, uncertain, and busy": The impact of "The new 1-9 curriculum" reform on teacher preparation institutions. In Association of Promoting the Development of Teacher Education(Ed.). *The New 1-9 Curriculum and Teacher Education*, p. 18-37. Taipei, Taiwan: Wunan.
- Madison, S.K. (1997). Preparing efficacious elementary teachers in science and mathematics: The influence of methods courses. *Journal of Science Teacher Education*, 8 (2), 107-126.
- Ministry of Education, Taiwan (1999). *New regulations of teacher education*. Taipei, Taiwan: Author.
- Ministry of Education, Taiwan (2002). *The incorporation of public universities and colleges*. Taipei, Taiwan: Author.
- Ministry of Education, Taiwan (2004). *2004 Education in Republic of China*. Taipei, Taiwan: Author.
- National Research Council (1997). *Science teacher preparation in an era of standards-based reform*. Washington, DC: National Academy Press.
- National Research Council (2001). *Educating teachers of science, mathematics, and technology: New practices for the new millennium*. Washington, DC: National Academy Press.
- National Science Foundation (1996). *Shaping the future: New expectations for undergraduate education in science, mathematics, engineering, and technology*. Arlington, VA: National Science Foundation.
- Pajares, M. F. (1992). Teachers' beliefs and educational research: Cleaning up a messy construct. *Review of Educational Research*, 62, 307-332.
- Rodriguez, E.M. (1998). *Preparing quality teachers: Issues and trends in the States*. Washington, DC: State Higher Education Executive Officers.
- Romberg, T.A. (1994). *School mathematics options for the 1990s (Vol. 1). Chairman's report of a conference*. Washington, DC: Office of Educational Research and Improvement, U.S. Department of Education.
- Sanders, W.L., & Rivers, J.C. (1996). *Cumulative and residual effects of teachers on future student academic achievement*. Knoxville, TN: University of Tennessee Value-Added Research and Assessment Center.
- Wright, S.P., Horn, S.P., & Sanders, W.L. (1997). Teachers and classroom context effects on student achievement: Implications for teacher evaluation. *Journal of Personnel Evaluation in Education*, 11, 57-67.
- Wu, W. D. (2004). Challenges of teacher preparation and professional development. In The Chinese society of education and Chinese Teacher Association Society (Eds.). *Research in Issues of Teachers' Professional Development*, p. 3-24. Taipei, Taiwan: PE Press.



# SPATIAL ROTATION AND PERSPECTIVE TAKING ABILITIES IN RELATION TO PERFORMANCE IN REFLECTIVE SYMMETRY TASKS

Xenia Xistouri & Demetra Pitta-Pantazi

Department of Education, University of Cyprus

*The aim of this study is to examine the role of students' spatial rotation and perspective taking abilities and their performance on reflective symmetry tasks. The study was conducted with 10-12 year old students. The results suggest that students' mathematical performance in reflective symmetry tasks can be predicted by students' general mathematical achievement, perspective taking abilities and spatial rotation abilities, in descending order of importance. Thus, whereas general mathematical ability was the most important predictor for reflective symmetry tasks, perspective taking ability was more related to symmetry performance than spatial rotation. Additionally, gender and grade level were not found to be related to performance in symmetry.*

## INTRODUCTION

Research on spatial ability as a single component has indicated that it has a strong connection with transformational geometry (Clements & Battista, 1992). However, the level of impact that certain subcomponents of spatial ability, such as spatial visualization and spatial orientation, may have on mathematical performance is not clear. This lack of research is attributed to the obstacles associated with measuring the qualitatively different types of spatial abilities, since most tests seem to measure one type of mental visualization ability, that of mental rotation (Kozhevnikov & Hegarty (2001). However, nowadays such obstacles seem to be exceeded with the development of new psychometric tests (Kozhevnikov & Hegarty, 2001).

Hoyles and Healy (1997) suggest that success in reflective symmetry is accomplished by giving students the opportunity to view things from a different perspective. This may be an indication that the development of perspective-taking, a type of spatial orientation ability, may have an impact on performance in tasks of reflective symmetry. However, no pieces of research have looked into the relationship between spatial orientation and spatial visualization abilities and performance in solving reflective symmetry tasks. This is what this study aims to do.

## THEORETICAL BACKGROUND

### Distinction and Development of Spatial Abilities

Lean and Clements (1981) defined spatial ability as “the ability to formulate mental images and to manipulate these images in the mind” (p. 267). They also related it to mathematical achievement and mainly with geometry. However, they emphasized that its role in the construction of concepts is elusive and multifaceted. They also

---

2006. In Novotná, J., Moraová, H., Krátká, M. & Stehlíková, N. (Eds.). *Proceedings 30<sup>th</sup> Conference of the International Group for the Psychology of Mathematics Education*, Vol. 5, pp. 425-432. Prague: PME. 5 - 425

suggested that there are two major components of spatial abilities: spatial visualization and spatial orientation. Clements and Battista (1992, p.444) defined spatial visualization as the “comprehension and performance of imagined movements of objects in two- and three-dimensional space” and spatial orientation as the “understanding and operating on the relationships between the positions of objects in space with respect to one’s own position”. The similarity between these components is the updating of the relationship between the position of the object and the observer (Zacks, Mires, Tversky & Hazeltine, 2002). The difference lays on whether it is the position of the object or of the observer that is transformed. According to Hegarty and Waller (2004), some studies have questioned this distinction, because the two factors are often high correlated. Kozhevnikov and Hegarty (2001) called attention to the fact that, although the outcomes of object rotations and self-rotations in the same task may be equivalent, they are actually two tasks with different level of difficulty. Thus they developed the Object Perspective Taking Test, which was modelled after the types of stimuli used in previous experimental studies of perspective-taking.

Clements and Battista (1992) report that performance on spatial tasks increases with grade level. In a study by Epley, Morewedge and Keysar (2004), which compared the perspective taking abilities of children and adults, the results suggested that older children commit less egocentric errors than younger children and that perspective-taking becomes more efficient as a function of practice and experience. Spatial abilities have also been connected to gender in mathematical problem solving. In a study by Fennema and Tartre (1985), boys solved significantly more problems that emphasized the use of spatial visualization than girls. The researchers recommend investigating any gender-related differences in spatial visualization. The results of Zacks et al. (2002) suggest significant differences for the Mental Rotations Test, in favour of the females. There were no significant differences for the Perspective-taking test; however the males’ mean was higher.

### **Developing the Concept of Symmetry in Elementary School**

Research concerning the development and teaching of symmetry at the elementary level seems to be very poor and mainly focuses on teaching experiments that usually involve technological means. For example, Hoyles and Healy (1997) used a microworld tool to help students focus simultaneously on actions, visual relationships and symbolic representations regarding reflective symmetry. They describe students’ primitive and intuitional variety of strategies for solving paper and pencil tasks of reflective symmetry, with focus on the case of 12-year old Emily. The reflection of objects in horizontal or vertical mirror lines was easy for the students, but it was more difficult when the line was slanted. The researchers describe how Emily used an approximate strategy derived from paper folding. When the shape actually touched or crossed the mirror line, she constructed the image by prolonging the object through the mirror line and flipping – obtaining a rotation rather than a reflection. This may be an indication that children’s rotational abilities do not have a strong impact to their performance in symmetry tasks. What is important in this study is that Hoyles and Healy (1997) claim that Emily managed to construct the properties of reflection by

re-positioning herself in the world of turtles. Based on this remark, one may suppose that developing students' perspective-taking ability has an impact on their ability to solve reflective symmetry tasks. However, this needs to be examined. If this is valid, then it is our hypothesis that students' perspective taking ability will have a stronger relation to their performance in reflective symmetry tasks than their rotational ability.

The aim of this study is to examine the role of students' spatial rotation and perspective taking abilities and their performance in reflective symmetry tasks, across the upper grades of elementary school. The research questions are:

- What is the relation between students' mental rotation, perspective-taking mathematical achievement, and performance in reflective symmetry tasks?
- Which of the two spatial abilities – mental rotation and perspective-taking – is more related to performance in reflective symmetry tasks?
- Do mental rotation, perspective-taking and performance in reflective symmetry tasks change across the upper grades of elementary education?
- Which factors are more likely to predict students' performance in reflective symmetry tasks?

## **METHOD**

### **Participants**

The participants were 492 elementary students (244 males and 248 females). Specifically, 154 were 4<sup>th</sup> graders, 206 were 5<sup>th</sup> graders and 132 were 6<sup>th</sup> graders.

### **Material and Procedure**

Two psychometric tests were administered for measuring students' spatial abilities. The first was selected to assess students' mental rotation ability. The Mental Rotations Test (Vandenberg & Kuse, 1978) requires participants to identify rotated versions of three-dimensional objects composed by cubes. The score was the number of items answered correctly minus the number of items answered incorrectly.

The second test was selected to tap into participants' ability to perform egocentric perspective transformations. The Perspective-taking Test (Kozhevnikov & Hegarty, 2001) presents participants with a picture of an array of objects. With the array in view, they are asked to imagine themselves standing at one object, facing a second one, and they had to indicate the angle to a third object by drawing an X. Following Zacks et al. (2002) coding method, scores on the Perspective-taking Test are the average unsigned angular deviation from the correct answer, subtracted from 180 degrees. (Subtracting from 180 degrees produces scores that are higher for better performance, as for the other tests). Thus, scores can range from 0 to 180. The two tests were administered consecutively. Participants were given 10 minutes to complete the 8 items. They were strictly prohibited to rotate their paper, since this would give them a different perspective, which would not require any spatial transformations for solving (Hegarty & Waller, 2004).

To measure students' performance in mathematical tasks of reflective symmetry, a test was designed for the purposes of this study. It included seven tasks: 1) identifying given symmetrical shapes, 2) drawing lines of symmetry, 3) identifying letters with exactly two lines of symmetry (shapes not given), 4) identifying the symmetrical of a shape, 5) shading boxes for the symmetrical part of a shape, given the line of symmetry, 6) identifying the missing piece of a symmetrical shape, and 7) drawing the symmetrical of given shapes. Participants were given 40 minutes to complete all tasks. This test was given to the students separately and approximately a week apart from the psychometric tests. Each correct response to an item of each of the tasks was assigned a positive point. The total score for this test was the sum of positive points. The maximum of points a student could achieve was 53 points.

In addition to the above scores, the mathematics teachers of the classrooms were also requested to provide an objective grade of each student's mathematical achievement, ranking from 1 to 10.

### Statistical analyses

The t criterion was used to decide which spatial ability is more developed in students and to examine gender-related differences. For exploring relations between mental rotation, perspective-taking, mathematical achievement, and performance in symmetry, the Pearson's *r* coefficient was calculated. MANOVA analysis was performed to explore whether children's spatial abilities and performance in symmetry change across grade level. Finally, Stepwise Regression analysis was performed to explore which factors can predict performance in symmetry.

## RESULTS

Table 1 presents the means and standard deviations of males and females on the mental rotation test, the perspective-taking test and the symmetry test.

	Gender	Mean	SD	T	P
Mental rotation	Boys	2.40	2.75	2.022	0.044
	Girls	1.89	2.74		
Perspective-taking	Boys	115.09	34.02	0.843	0.011*
	Girls	112.53	29.42		
Symmetry	Boys	30.78	9.12	-1.453	0.147
	Girls	31.94	8.21		

$p < 0.05$ ,  $N = 492$

Table 1: Means and standard deviations of boys' and girls' scores on all tests, *t* values, and significance

In regard to the relationship between gender and spatial abilities, no gender-related differences appear in the case of the mental rotation test score, while they appear for the perspective-taking test score. It seems that boys have performed slightly better than girls in the perspective-taking test. However, no significant difference is found between the boys' and girls' means on the symmetry performance test.

Table 2 presents the means and standard deviations of students' mental rotation and perspective-taking scores, t value, and the significance of the mean difference. For the purposes of the means comparison, both tests were converted to a scale of 12.

Test	Mean	Standard Deviation	t	P
Mental rotation	6.17	2.76	-9.235	0.001
Perspective-taking	7.58	2.12		

N=492

Table 2: Means and standard deviations of students' mental rotation and perspective-taking scores, t value, and significance

It is clear that students have higher perspective taking abilities rather than mental rotation abilities. The mean difference is 1.41 at level of significance  $p < 0.01$ .

	Mathematical Achievement	Mental Rotation	Perspective-taking
Mental Rotation	0.203*		
Perspective-taking	0.180*	0.168*	
Symmetry Performance	0.430*	0.298*	0.304*

\* $p < 0.01$ , N=492

Table 3: Correlations among overall mathematical achievement, mental rotation test score, perspective-taking test score, and performance on the symmetry test

High correlations appear between mathematical achievement and both components, which is in line with Clement's and Battista's (1992) results. There is also correlation between perspective-taking and mental rotation. Students' performance in the symmetry test appears positively related to all variables, at a good level of significance ( $p < 0.01$ ). Particularly, mathematical achievement has the highest correlation coefficient ( $r = 0.430$ ), perspective-taking has the second highest correlation coefficient ( $r = 0.304$ ) and mental rotation has the lowest ( $r = 0.298$ ).

Considering the fact that there are significant correlations between spatial abilities and performance in symmetry, it would be valuable to examine the correlations between mathematical achievement, the spatial abilities and each of the tasks. Table 4 shows that success in every task has the highest correlation with mathematical achievement, except in task 7b. Mental rotation has the second highest correlation, with the exception of tasks 2, 7a and 7b, which are more related with perspective-taking. This could be evidence that while other tasks can be solved with analytic strategies, drawing the symmetrical of a shape (tasks 7a and 7b), especially in the case of a slanted line of symmetry (task 7b), requires more abilities, those of spatial nature. Similarly, it appears that the ability to find the line of symmetry of a shape, as in task 2, requires viewing a shape from different perspectives, in order to decide the perspective from which the shape seems reflected. Only task 6, identifying the part of a symmetrical shape, was not related to perspective-taking. This might be due to the fact that it could be solved by mentally moving the pieces and placing them in the

position of the missing part, and this action is considered to be more of a spatial visualization action rather than of spatial orientation.

TASK	Mathematical Achievement	Mental Rotation Score	Perspective-taking Score
1. Identify symmetrical shapes	0.255**	0.159**	0.113*
2. Find lines of symmetry	0.283**	0.196**	0.268**
3. Identify letters with 2 lines of symmetry	0.228**	0.203**	0.152**
4. Find the symmetrical shape	0.252**	0.225**	0.179**
5. Fill in the symmetrical part	0.305**	0.131**	0.120*
6. Identify the missing part of a symmetrical shape	0.214**	0.194**	0.90
7a. Draw symmetrical of a shape with vertical line of symmetry	0.317**	0.145**	0.251**
7b. Draw symmetrical of a shape with slanted line of symmetry	0.187**	0.227**	0.239**

\*p<0.05, \*\*p<0.01, N=492

Table 4: Correlations between mathematics performance, spatial abilities, and tasks

In regard to the relation between spatial abilities and grade level, a MANOVA analysis showed that the only statistically significant mean difference appears between the means for the perspective-taking test (Pillai's Trace=0.032,  $F(6,848) = 2,272$ ,  $p<0.05$ ). Post-hoc examinations revealed that the difference is significant only between the means of the 4<sup>th</sup> and the 6<sup>th</sup> grade. This is in line with Epley's et al. (2004) report that performance on spatial tasks increases with age.

Regarding to the prediction of performance in reflective symmetry tasks, the Regression analysis showed that the statistically significant predictive factors are, in this order of significance: students' mathematical achievement (Beta=0.306,  $t=6.997$ ,  $p<0.001$ ), perspective-taking score (Beta=0.220,  $t=5.042$ ,  $p<0.001$ ) and mental rotation score (Beta=0.185,  $t=4.230$ ,  $p<0.001$ ). These factors account for up to 23.2% of the variation of their performance in symmetry. On the contrary, elementary grade (Beta=0.063,  $t=1.454$ ,  $p=0.147$ ) and students' gender (Beta=0.056,  $t=1.313$ ,  $p=0.190$ ) do not contribute to the prediction of students' performance in symmetry.

## DISCUSSION

Significant positive relationship was found between both spatial abilities and performance in symmetry, as well as with mathematical achievement. It is interesting that, although mental rotation seems to be more related to mathematical achievement than perspective-taking, the same relation does not appear for performance in symmetry, which seems to be more related to perspective-taking. Nevertheless, the strongest correlation was between mathematical achievement and performance on the symmetry test. Additionally, the strong relation between perspective-taking and

performance in symmetry provides feedback on Hoyles's and Healy's (1997) conjecture that the opportunity to view from another perspective contributes to the improvement of students' understanding and performance in symmetry.

Another correlation was found between the two types of spatial ability. This was not surprising, since previous researchers (Kozhevnikov & Hegarty, 2001; Zacks et al., 2002; Hegarty & Waller, 2004) claim that not only they are highly correlated, but the dissociation between the two factors is rather difficult. However, the correlation was not found as strong as proposed by these researchers. This might be due to the young age of the population of this study, compared to the college-level population of the aforementioned studies. Perhaps younger children consider the tasks very different and do not recognize the similarities that adults do; as a result, they may behave differently to adults when they mentally visualize each condition. This might be in contrast with Epley's et al. (2004) suggestion that children and adults express the same egocentric behaviour with the only difference being on the amount of efficiency of the process. Nevertheless, this study also provides evidence that different symmetry tasks may require different abilities. Although all tasks are more related to mathematical achievement, only the task of drawing the symmetrical of an object with a slanted line appears to be more related to other abilities. Similarly, in Hoyles's and Healy's (1997) study, the most difficult tasks for the students were the ones with a slanted mirror. The results of this study suggest that such tasks require more spatial than cognitive abilities and particularly more spatial orientation abilities (perspective-taking) rather than spatial visualization abilities (mental rotation).

According to Fennema and Tartre (1985), boys seem to be better than girls in spatial visualization. Considering the fact that the components of spatial ability were not very distinct and that there were no appropriate measurements for the different factors at that time, one can only suppose the existence of some difference on spatial abilities between genders, but without knowing certainly which one outraces. This study suggests that boys are better than girls at perspective-taking. Therefore, one may conjecture that in general, boys may have more developed spatial orientation abilities than girls, while both genders' spatial visualization abilities have no significant difference. However, this difference on spatial orientation abilities did not seem to have a significant impact on the symmetry performance test, since the mean difference was not significant. It is also important that performance in symmetry tasks is not significantly differentiated across the upper grades of elementary school. Moreover, there was no significant difference on the three grades' mean scores on the mental rotation test, but there was statistically significant difference on their perspective-taking score, which is in line with Epley's et al. (2004) and Clements's and Battista's (1992) proposition that performance on spatial tasks increases with grade level. This implies that one's spatial visualization abilities may not develop with age, but their spatial orientation abilities do.

The main conclusion of this study is that the most significant factors for predicting performance in reflective symmetry tasks are mathematical achievement, perspective-taking and mental rotation, in descending order of significant importance.

Grade level and gender do not appear to be significant predictors of performance in solving symmetry tasks.

Nevertheless, there are some teaching implications to be discussed. Spatial abilities play an important role to performance in symmetry. To improve students' performance in symmetry and mathematics, it may be important to develop their spatial abilities. However, teachers tend to over-emphasize the rotational aspect of symmetry, by teaching it through paper-folding activities, which are more related to spatial visualisation. For this reason, more teaching experiments are required in order to find effective ways for teaching symmetry through developing spatial abilities. Teaching should not only emphasize on mental rotation, but also on imagining the views of a shape from different perspectives. It is conjectured that this will contribute to the development of students' spatial abilities, and therefore to the improvement of their performance in symmetry and their mathematical achievement.

## References

- Clements, D. H., & Battista, M. T. (1992). Geometry and spatial reasoning. In D.A. Grows (Ed.), *Handbook of Research in Mathematics Teaching and Learning*. New York: McMillan
- Epley, N., Morewedge, C. K., & Keysar, B. (2004). Perspective taking in children and adults: Equivalent egocentrism but differential correction. *Journal of Experimental Social Psychology*, 40, 760–768.
- Fennema, E., & Tartre, L. A. (1985). The use of spatial visualization in mathematics by girls and boys. *Journal for Research in Mathematics Education*, 16 (3), 184-206.
- Hegarty, M., & Waller, D. (2004). A dissociation between mental rotation and perspective-taking spatial abilities. *Intelligence*, 32, 175–191.
- Hoyles C., & Healy L. (1997). Unfolding meanings for reflective symmetry. *International journal of computers in mathematical learning*, 2 (1), 27-59.
- Kozhevnikov, M., & Hegarty, M. (2001). A dissociation between object-manipulation spatial ability and spatial orientation ability. *Memory and Cognition*, 29, 745–756.
- Lean, G., & Clements, M. A. (1981). Spatial ability, visual imagery and mathematics performance. *Educational Studies in Mathematics*, 12, 267-299.
- Vandenberg, S. G., & Kuse, A. R. (1978). Mental rotations, a group test of three-dimensional spatial visualization. *Perceptual and Motor Skills*, 47, 599–604.
- Zacks, J. M., Mires, J., Tversky, B., & Hazeltine, E. (2002). Mental spatial transformations of objects and perspective. *Spatial Cognition and Computation*, 2, 315–332.



# ELEMENTARY TEACHERS' MATHEMATICS BELIEFS AND TEACHING PRACTICES AFTER A CURRICULUM REFORM

Shirley M. Yates

Flinders University • Adelaide • Australia

*Beliefs about mathematics, mathematics teaching and learning, teaching practices and curriculum reform experiences were surveyed in 127 experienced elementary classroom teachers in 21 schools in Term 4, 2005. All teachers had been required to enact a constructivist approach to mathematics teaching since 2001, with classroom use of Information and Communication Technologies promoted. Teachers' espoused beliefs about mathematics were unrelated to their beliefs about mathematics teaching and learning. Furthermore, teachers' beliefs differed, with those with stronger beliefs making greater use some constructivist teaching practices. Teachers experiencing a high number of reforms utilised computers and the internet more often in lessons and sought constructive information about student mathematics learning more frequently.*

It is widely recognised that teachers' personal beliefs and theories about mathematics and the teaching and learning of mathematics play a central role in their teaching practices (Handal & Herrington, 2003; Kagan, 1992; Pajares, 1992) and implementation of curriculum reform (Handal & Herrington, 2003). It is unclear whether teachers' beliefs influence instructional behaviour or whether their practices influence their beliefs (Buzeika, 1996). What is clear however is that teacher beliefs are robust (Pajares, 1992), resistant to change (Block & Hazelip, 1995; Kagan, 1992), serve as filters for new knowledge (Nespor, 1987; Pajares, 1992) and act as barriers to changes in teaching practices (Fullan & Stegelbauer, 1991). Furthermore, teachers' beliefs can either facilitate or inhibit curriculum reform (Burkhardt, Fraser & Ridgway, 1990; Koehler & Grouws, 1992; Sosniak, Ethington & Varelas, 1991).

Failure in curriculum reform in mathematics is a significant problem worldwide. Teachers hold the key to reform in mathematics education (Battista, 1994), with a lack of congruence between curriculum innovation intent and teachers' pedagogical knowledge, beliefs and practises the most cited reason for the poor history of reform in mathematics. Cuban (1993) describes this as a mismatch between the official curriculum prescribed by policy makers and the actual curriculum taught by teachers in classrooms, a phenomenon demonstrated in mathematics through case studies in several countries (Brew, Rowley & Leder, 1996; Buzeika, 1996; Konting, 1998; Sowell & Zambo, 1997). Most mathematics education reforms have been introduced by education authorities through a top-down approach (Kyeleve & Williams, 1996; Moon, 1986) which ignores teachers' beliefs and pedagogical practices and the changes which would be necessary for them to be able to embrace the innovation (Norton, McRobbie & Cooper, 2002; Perry, Howard & Tracey, 1999).

---

2006. In Novotná, J., Moraová, H., Krátká, M. & Stehlíková, N. (Eds.). *Proceedings 30<sup>th</sup> Conference of the International Group for the Psychology of Mathematics Education*, Vol. 5, pp. 433-440. Prague: PME. 5 - 433

In elementary schools all teachers are required to teach mathematics, but most are ill-prepared for the task (Battista, 1994). Most experienced elementary teachers have not acquired a deep understanding of mathematics (Gregg, 1995), as they are products of the traditional mathematics-as-computation view of teaching in which mathematics was regarded as a transmitted set of facts and procedures. For curriculum reform to be successful teachers must challenge their prevailing attitudes and beliefs about the nature of mathematics (Sirotnik, 1999; Soder, 1999) rather than simply making cosmetic changes to their practices (Fullan, 1993). More recent reforms however, also require teachers to broaden their mathematical knowledge and competencies (Battista, 1994). This is particularly evident for the incorporation of Information and Communication Technologies (ICT) into the teaching and learning of mathematics which requires teachers to shift from traditional transmission views of mathematics pedagogy (National Research Council, 1989; Perry, Howard & Conroy, 1996;) to more child-centred constructivist views (Perry *et al.*, 1999).

## THE PRESENT STUDY

This study took place in elementary schools operated by the Department of Education and Children's Services (DECS) which introduced a *South Australian Curriculum Standards and Accountability Framework (SACSA)* across all curriculum areas in 2001 and promoted the use of ICT as a strategic direction for mathematics education. SACSA is based on constructivism which *views learning as an active process in which learners construct new ideas or concepts based on their current and past understandings* (DECS, 2001). Teachers selected to participate in this study had 10 or more years of teaching mathematics so had taught mathematics prior to and after the introduction of SACSA. The survey administered to the teachers incorporated a rating scale research instrument developed by Perry *et al.* (1996) to investigate teachers' beliefs about mathematics and the teaching and learning of mathematics, but it also measured their current pedagogical practices in mathematics and their experiences with curriculum reforms in mathematics.

### Aims of the study

This study had four aims:

- 1 To examine experienced teachers espoused beliefs about mathematics and the teaching and learning of mathematics after the introduction of the SACSA curriculum reform;
- 2 To investigate experienced teachers current classroom teaching practices in mathematics;
- 3 To identify the number of curriculum reforms in mathematics that teachers have experienced; and
- 4 To explore relationships between teachers' espoused beliefs about mathematics and the teaching and learning of mathematics, current classroom practices and reform experiences.

## METHOD

### Participants

One hundred and twenty-seven elementary teachers in 21 DECS schools participated. Sixty-four teachers had a basic teaching qualification, 45 held a Bachelor degree and 18 had postgraduate qualifications. The 29 male and 98 female teachers ranged in age from 30 to 62 years with a median age of 51 years and had been teaching mathematics from 10 to 31+ years with a median range of 26 to 30 years. Teachers had experienced between 2 to 15 curriculum reforms, with a median of 9 reforms.

### The Survey

The survey measured teachers' age, qualifications, years of teaching mathematics, beliefs and practices in mathematics and experiences of curriculum reform. Teachers' years of teaching mathematics were categorised in five yearly increments, with the final increment measuring 31 or more years of teaching. Beliefs about mathematics and the teaching and learning of mathematics were measured on 20 items developed by Perry *et al.* (1996) from various mathematics education reform statements (Australian Education Council, 1991; Mumme & Weissglass, 1991; Wood, Cobb & Yackel, 1992). Each item was rated on a four point scale ranging from 1 (*strongly disagree*) to 4 (*strongly agree*). Teachers also rated 10 statements about their current mathematics teaching practices in relation to assessment, use of manipulatives, worksheets, textbooks and ICT (calculators, computers and the internet) on a four point scale from 1 (*never used*), 2 (*occasionally used*), 3 (*used once or twice a week*) to 4 (*daily use*). Teachers identified the curriculum reforms in mathematics they had experienced from a list of 15 reforms introduced since the 1960s. These included mathematics education innovations such as Cuisenaire and New Math that had been enacted in many countries and specific DECS reforms such as Statements and Profiles and the SACSA framework initiated across all curriculum areas.

### Procedure

Surveys were distributed to the selected teachers in each school by reply-paid post between October and December, 2005 (the fourth and final school term in 2005).

## RESULTS

Survey data for 127 teachers were entered into an SPSS programme. The 20 belief items (Perry *et al.*, 1996) were analysed with Principal Components Analysis, with the factor loadings shown in Table 1 based on an Oblimin two factor resolution. Factor 1 is composed of 8 items reflecting teachers' constructivist beliefs about the teaching and learning of mathematics and Factor 2 teachers' beliefs about the beauty and meaningfulness of mathematics. The factor scores correlation of 0.11 is not significant. Mean scores in Table 1 are expressed on a 4 point scale from 1 (*strongly disagree*) to 4 (*strongly agree*). These two factors were then used to explore relationships between teachers' espoused beliefs, reported pedagogical practices, and curriculum reform experiences.

No.	Item	Loading	Mean
<i>Factor 1: Teachers' constructivist beliefs about mathematics teaching and learning</i>			
13	Mathematics learning is enhanced by activities which build upon and respect students' experiences	0.60	3.46
14	Mathematics learning is enhanced by challenge within a supportive environment	0.60	3.64
17	The role of the mathematics teacher is to transmit mathematical knowledge and to verify that learners have received this knowledge (R)	-0.57	2.33
2	Mathematics problems given to students should be solvable quickly in a few steps (R)	-0.56	2.15
1	Mathematics is computation (R)	-0.53	2.49
19	Teachers should negotiate social norms with the students in order to develop a cooperative learning environment in which students can construct their knowledge	0.53	3.23
10	Periods of uncertainty, conflict, confusion and surprise are a significant part of the mathematics learning process	0.53	3.18
18	Teachers should recognise that what seem like errors and confusions from an adult point of view are students' expressions of their current understanding	0.51	3.20
<i>Factor 2 Teachers' beliefs about the beauty and meaningfulness of mathematics</i>			
7	Mathematics knowledge is the result of the learner interpreting and organising the information gained from experiences	0.65	3.24
3	Mathematics is the dynamic searching for order and pattern in the learner's environment	0.58	3.29
5	Mathematics is a beautiful, creative and useful human endeavour that is both a way of knowing and a way of thinking	0.55	3.09
8	Students are rational decision makers capable of determining for themselves what is right and wrong	0.51	2.49

Table 1: Factor analysis of teachers' espoused beliefs.

Relationships between teachers' constructivist beliefs about the teaching and learning of mathematics and their reported practices were investigated with analysis of variance (ANOVA), with the results presented in Table 2. Teachers were grouped in relation to Factor 1 by means of a quartile split, with 26 teachers scoring in the upper quartile (Mean = 28.6 out of a possible 32) and 29 teachers scoring in the lower quartile (Mean = 20.9). The ANOVA revealed significant differences between these two groups of teachers in three of the 10 teaching practices measured by the survey (see Table 2).

Significant correlations between teachers' beliefs in the beauty and meaningfulness of mathematics were found for two teaching practices (see Table 3). The negative correlation between Factor 2 and worksheet use indicates that teachers with stronger

beliefs in the beauty and meaningfulness of mathematics used worksheets less frequently while the positive correlation indicates more frequent use of manipulatives.

Reported teaching practices	High v's low constructivist teacher means
Students in my class use manipulatives during maths lessons	3.24 versus 2.69 $F(1,53) = 7.1, p = 0.01$
I give students worksheets in maths lessons	2.24 versus 2.58 $F(1,53) = 4.6, p = 0.04$
I use tests to assess student knowledge and understanding of maths	2.00 versus 2.23 $F(1,53) = 3.01, p = 0.08$

Table 2: ANOVA of teacher constructivist beliefs and teaching practices.

Relationships between teachers' beliefs about mathematics and practices	<i>r</i>
Students in my class use manipulatives during maths lessons	0.22*
I give students worksheets in maths lessons	- 0.22*

\* $p = 0.05$  (2-tailed)

Table 3: Correlations between teachers' beliefs about the beauty and meaningfulness of mathematics and their teaching practices.

The number of curriculum reforms teachers reported having experienced was not related significantly to either their Factor 1 constructivist teaching beliefs or Factor 2 beliefs about the beauty of mathematics. Furthermore, teacher age, qualifications and length of experience in teaching mathematics were not related significantly to Factor 1, Factor 2 or any of the 10 teaching practices measured in the survey. However, the number of reforms experienced was related significantly to four teaching practices (see Table 4). Teachers who scored highly on the number of reforms experienced needed to know what students understood in mathematics more often. They also reported using tests, computers, and the internet more frequently with students.

Relationship between number of curriculum reforms and teaching practices	<i>r</i>
I use tests to assess student knowledge and understanding of maths	0.18*
Students in my class use a computer during maths lessons	0.20*
I need to know what student have understood in maths	0.18*
Students in my class use the internet during maths lessons	0.18*

\* $p = 0.05$  (2-tailed)

Table 4: Correlations between reforms experienced by teachers and their practices.

## DISCUSSION

This study took place almost five years after the inauguration of a constructivist curriculum reform and focussed on teachers whose average age would place them firmly as receiving their elementary mathematics education during the rule-based transmission view of mathematics-as-procedures (Battista, 1994) era. Battista paints a

somewhat dismal picture of experienced elementary teachers caught in a *pernicious cycle of mathematical mislearning* (1994, p. 468), whereby their traditional beliefs serve to block their enactment of more recent constructivist innovations. However, this study found teachers' beliefs about mathematics and beliefs about the teaching and learning of mathematics were not related to their age, qualifications or length of teaching experience. Furthermore, their beliefs about the nature of mathematics were unrelated to their beliefs about the teaching and learning of mathematics. Teachers did differ in their beliefs and this was related significantly to some child-centred practices. Teachers holding strong views about the beauty of mathematics and those that scored highly on constructivism used manipulatives more often and worksheets less often in mathematics lessons. The latter group also used tests less frequently.

While the finding that teacher age, qualifications and length of mathematics teaching experience were not significantly related to their teaching practices is somewhat unexpected, the significant relationship between that the sheer number of reforms experienced by teachers and their use of ICT and some assessment practices is of particular interest. Teachers in this study had been teaching mathematics on average from 26 to 30 years and had experienced an average of nine curriculum reforms over that time – this means that on average they had experienced one reform every three years. While some were mathematics education reforms enacted in many countries, others were initiated solely by DECS. The cumulative effects of numerous reform experiences on some teaching practices would suggest a reconsideration of the general consensus that mathematics education innovations have failed (Battista, 1994; Handal & Herrington, 2003). Educational change takes place slowly over time (Eltis & Mowbray, 1997). While reasons why some teachers are more likely to take up reform initiatives remains a fruitful area for future research, it appears that repeated exposure to reform initiatives over time caused some teachers to update their practices. This is evidenced by their significantly greater classroom use of ICT and more frequent need for constructive information about student mathematics learning.

The National Council of Teachers of Mathematics (1999) has asserted collaboration between researchers and teachers is critical if mathematics education research is to be responsive to questions regarding pedagogy and student learning. This study identified some significant relationships between teachers' beliefs, practices and curriculum reforms experiences in mathematics at the elementary level. The survey data gathered should be enriched with written accounts, interviews and observations of teachers' practices and the study extended to include middle school teachers.

**Acknowledgements** Assistance from Marilyn Rogers and Dianne Harris is gratefully acknowledged.

## References

- Australian Education Council (1991). *A national statement on mathematics in Australian schools*. Melbourne: Curriculum Corporation.
- Battista, M. T. (1993). Teacher beliefs and the reform movement in mathematics education. *Phi Delta Kappan*, 75, 462-470.

- Block, J. H. & Hazelip, K. (1995). Teachers' beliefs and belief systems. In L. W. Anderson (ed.), *International encyclopaedia of teaching and teacher education* (2<sup>nd</sup> ed., pp.25-28). New York: Pergamon Press.
- Brew, C., Rowley, G. & Leder, G. (1996). Teachers' perceptions of VCE mathematics: A response to "teething" problems? In H. Forgasz, T. Jones, G. Leder, J. Lynch, K. Mcguire & C. Pearn (Eds.), *Mathematics: Making Connections* (pp. 343-348) Melbourne: Mathematical Association of Australia.
- Burkhardt, H., Fraser, R. & Ridgway, J. (1990). The dynamics of curriculum change. In I. Wirszup & R. Streit (Eds.), *Development in school mathematics education around the world* (Vol. 2, pp. 3-29). Reston, VA: NCTM.
- Buzeika, A. (1996). Teachers' beliefs and practice: The chicken or the egg? In P. C. Clarkson (Ed.), *Technology in mathematics education*. Proceedings of the 19<sup>th</sup> Annual Conference of the Mathematics Education Research Group of Australasia (pp. 93-100). Melbourne: MERGA.
- Cuban, L. (1993). The lure of curriculum reform and its pitiful history. *Phi Delta Kappan*, 75(2), 182-185.
- Department of Education and Children's Services (2001). *South Australian Curriculum, Standards and Accountability Framework*. South Australia: Government of South Australia.
- Eltis, K. and Mowbray, B. (1997). Focusing on learning in New South Wales. In J. Lohan (Ed.), *Describing learning: Implementation of curriculum profiles in Australian schools 1986-1996*. Camberwell, Vic: Australian Council for Educational Research.
- Fullan, M. (1993). *Changing forces: Probing the depths of educational reform*. London, UK: Falmer Press.
- Fullan, M. & Stegelbauer, S. (1991). *The new meaning of educational change*. New York: Cassell.
- Gregg, J. (1995). The tensions and contradictions of the school mathematics tradition. *Journal for Research in Mathematics Education*, 26(5), 442-466.
- Handal, B. & Herrington, A. (2003). Mathematics teachers' beliefs and curriculum reform. *Mathematics Education Research Journal*, 15(1), 59-69.
- Kagan, D. M. (1992). Implications of research on teacher belief. *Educational Psychologist*, 27, 65-90.
- Koehler, M. S. & Grouws, D. A. (1992). Mathematics teaching practices and their effects. In D. A. Grouws (Ed.), *Handbook of research in on mathematics teaching and learning* (pp. 115-126). New York: Macmillan.
- Konting, M. M. (1998). In search of good practice: a case study of Malaysian effective mathematics teachers classroom teaching. *Journal of Science and Mathematics Education in South East Asia*, 20(2), 8-20.
- Kyeleve, J. I. & Williams, J. S. (1996). Measures of teachers' attitudes towards mathematical modelling. In L. Puig & A. Gutierrez (Eds.), *Proceedings of the 20<sup>th</sup> Conference of the International Group for the Psychology of Mathematics Education* (Vol. 3) (pp. 209-216). Valencia, Spain: Universitat de Valencia.

- Moon, R. (1986). *The 'New Maths' curriculum controversy: An international story*. London, UK: Falmer.
- Mumme, J. & Weissglass, J. (1991). Improving mathematics education through school-based change. *Issues in Mathematics Education Offprint*. American Mathematical Society and Mathematical Association of America.
- National Council of Teachers of Mathematics (1999). *Research*. Accessed 11 October, 2005 at [http://www.nctm.org/about/position\\_statements/position\\_statement\\_11.htm](http://www.nctm.org/about/position_statements/position_statement_11.htm).
- National Research Council (1989). *Everybody counts: A report to the nation on the future of mathematics education*. Washington, DC: National Academy Press.
- Nespor, J. (1987) The role of beliefs in the practice of teaching. *Journal of Curriculum Studies*, 19, 317-328.
- Norton, S. McRobbie, C. & Cooper, T. (2002). Teachers' responses to an investigative mathematics syllabus: Their goals and practices. *Mathematics Education Research Journal*. 14(1), 37-59.
- Pajares, M. F. (1992). Teachers beliefs and educational research: Cleaning up a messy construct. *Review of Educational Research*, 62, 307-332.
- Perry, B., Howard, P. & Conroy, J. (1996). K-6 teacher beliefs about the learning and teaching of mathematics. In P. C. Clarkson (Ed.), *Technology in mathematics education*. Proceedings of the 19<sup>th</sup> Annual Conference of the Mathematics Education Research Group of Australasia (pp. 453-460). Melbourne: MERGA.
- Perry, B., Howard, P. & Tracey, D. (1999). Head mathematics teachers' beliefs about the learning and teaching of mathematics. *Mathematics Education Research Journal*, 11(1), 39-53.
- Sirotnik, K. A. (1999). Making sense of educational transformation. *Phi Delta Kappan*, 80(8), 606-610.
- Soder, R. (1999). When words find their meaning: Transformation versus reform. *Phi Delta Kappan*, 80(8), 568-579.
- Sosniak, L. A., Ethington, C. A. & Varelas, M. (1991). Teaching mathematics without a coherent point of view: Findings from the IEA Second International Mathematics Study. *Journal of Curriculum Studies*, 23, 119-131.
- Sowell, E. & Zambo, R. (1997). Alignment between standards and practices in mathematics education: Experiences in Arizona. *Journal of Curriculum and Supervision*, 12(4), 344-355.
- Wood, T. Cobb, P. & Yackel, E. (1992). Change in learning mathematics: Change in teaching mathematics. In H. Marshall (Ed.), *Redefining student learning: Roots of educational change* (pp. 177-205). Norwood, New Jersey: Ablex.



# INQUIRY ACTIVITIES IN A CLASSROOM: EXTRA-LOGICAL PROCESSES OF ILLUMINATION VS LOGICAL PROCESS OF DEDUCTIVE AND INDUCTIVE REASONING. A CASE STUDY

Oleksiy Yevdokimov

The University of Southern Queensland, Australia

*The paper presents results of the research, which was focused on studying students' inquiry work from a psychological point of view. Inquiry activities of students in a classroom were analysed through the evaluation of the character of these activities within learning process with respect to mathematician's research practice. A process of learning mathematical discovery was considered in details as a part of inquiry activities of students in a classroom.*

## INTRODUCTION

Different questions dealing with the nature of mathematical discovery and inquiry activities have always been in the focus of researchers' interest (Krutetskii, 1976; Polya, 1962; Tall, 1980). Among the outstanding mathematicians, who paid great attention to the topic, were Hadamard (1945) and Poincaré (1952), though they had mostly relied upon personal experience. Historical analysis of the process of mathematical discovery was given by Lakatos (1976). Nowadays the phenomenon of mathematical discovery, its mechanism and mental processes remain into the educational research limelight (Barnes, 2000; Burton, 1999; Devlin, 2000; Okada & Simon, 1997; Sinclair, 2002). Indeed, the concepts of inquiry and mathematical discovery have quite many common features with learning process for being considered together. Nevertheless, much of the previous work on the process of mathematical discovery in the mathematics education literature had often been concentrated upon mathematicians and their research practice without clear indication to the needs and objectives of learning process and subjects involved in. Moreover, most of the contributions concerned the illumination stage of mathematical discovery. In this respect a recent paper by Liljedahl (2004) emphasizes the situation:

Mathematical discovery and invention are aspects of 'doing' mathematics that have long been accepted as standing outside of the theories of "logical forms". That is, they rely on the extra-logical processes of insight and illumination as opposed to the logical process of deductive and inductive reasoning. (p.256)

At the same time, it is obvious that within any educational process the great part of it should be provided by the teacher and carried out by the students on the base of using logical processes of deductive and inductive reasoning and links between them. This contrast raises the main question of our research: To analyse relationships between extra-logical processes of illumination and logical processes in the scope of students' inquiry activities in a classroom and what are the ways of evaluation of students'

inquiry work in such situation? Also, we would like to lift up other questions related to the mentioned above: Whether is it possible to develop students' skills and understanding of different mathematical ideas up to advanced level through the appropriately designed inquiry tasks and environment in classroom activities? How much of students' argumentation in inquiry work do the logical links take in?

We shall attempt to answer these questions in the context of using different forms of students' inquiry activities in a classroom.

## THEORETICAL FRAMEWORK

At first, we need to define more precisely a main object of the research. This is a process of learning mathematical discovery in a classroom. We understand *learning mathematical discovery in a classroom* as a short-term active learning process aimed at the development of students' abilities to assimilate new knowledge through the use and interpretation of their existing knowledge structures with the help of a teacher or with considerable autonomy and only teacher's control of the direction of the inquiry activities within the topic studied. We would like to note that the term *inquiry work in a classroom* or *inquiry activities* is usually used in the mathematics education literature. However, we have intentionally introduced the term *learning mathematical discovery in a classroom* to emphasize the difference between it and the above terms. A process of learning mathematical discovery in a classroom has a completed and local character. Moreover, it is restricted with some questions of curriculum and short time limits. Therefore, we would like to study a small, though the most important part of inquiry activities in zoom.

The most important point was to find out how natural for students was a process of learning mathematical discovery in a classroom from a psychological point of view, i.e. whether it meant when students had revealed some property of the topic studied they had been mentally prepared in advance that it happened only due to illumination and intuition, without logical links to their argumentation in inquiry activities. To answer this question, we had to know how we could evaluate the relationship between logical and extra-logical processes, of which mathematical discovery consists of, within the students' inquiry work in a classroom. Thus, it was necessary to introduce quantitative and qualitative characteristics, which would describe a process of learning mathematical discovery in a classroom.

We took the position that AFKS (Active Fund of Knowledge of a Student, Yevdokimov, 2003) had the most relevant structure to introduce such characteristics for studying this process. We understand AFKS as student's knowledge of definitions and properties for some mathematical objects of a certain topic and skills to use that knowledge in inquiry work. The key point of using AFKS in the context of learning mathematical discovery was the following: where, when and for what mathematical objects a student would apply a certain mathematical property or action and whether it would be necessary to apply that property or action in that case in general. It was obvious that with respect to the process of learning mathematical discovery in a classroom AFKS represents, first of all, student's using of logical process of

deductive and inductive reasoning. Also, we followed Edwards' idea *conceptual territory before proof* (1997) in investigating the process of learning mathematical discovery in a classroom and taking into account that exploration and explanation constituted the main elements that preceded formal discovery.

## METHODOLOGY

Five 10 Grade classes with mathematics profile from different schools (students' age 16 years) were involved in the study in January 2005. All students had been proposed the same advanced course of plane geometry (college geometry), which was conducted by five experienced teachers. The content of the course had been unknown to all students before, though they were familiar with mathematical concepts, objects, their definitions and basic properties related to the theme. The course was organised in the following way: During the first month teachers presented new material one time (45 minutes) per week, with significant amount of questions and problems of different complexity levels for students' work on their own. The next month teaching was focused on using different forms of students' inquiry work in a classroom: there were two lessons (90 minutes) two times per week. At the end of this month two tasks were proposed to students in the scope of a certain form of learning mathematical discovery. We indicated this procedure as Phase 1 of the study. After that the second cycle of two months was carried out with corresponding Phase 2 in the end. The same cycle with corresponding Phase 3 completed the first part of our project. We had intentionally separated Phases 1, 2 and 3 with months of teachers' presentation. We had tried to provide conditions, where students' thinking was not concentrated on a certain form of learning mathematical discovery and students' using stereotyped approaches to inquiry work was minimal. Before Phase 1, two most successful students in each class had been distinguished by the teachers for the study. We regarded two students as most successful in a class (not necessarily talented or genius), if they had dominated over the rest of the students in the same class during the time period before Phase 1 at least in 2 points from the following ones: deep understanding theoretical material given by a teacher, solving/proving complex problems, posing non-trivial problems related to the theme. Starting from that point inquiry activities of those 10 students had been under peer observation of the teachers. Thus, taking into account specification of the theme of our study we took the best part of the students for evaluation their work in learning mathematical discovery in a classroom. At the same time, to provide real results of students' achievements, all 5 pairs of students were in their usual social classroom environments during the study. The rest of the students in each class played the technical role being involved in inquiry activities in a classroom. However, such information was for teachers' use only. For analysis we used students' protocol sheets of the corresponding phase tasks and teachers' commentaries to them, teachers' notes concerning students' inquiry work in a classroom and audio-files of fragments of the lessons. Finally we took short students' interviews about their beliefs on the process of mathematical discovery and attitudes to different forms of learning mathematical discovery in a classroom.

For quantitative evaluation of student's conscious involvement in the process of learning mathematical discovery in a classroom we determined an index  $I$  using AFKS in that process, i.e.  $I$  served an indicator how much AFKS was used in doing each task. We studied the character (logical or non-logical) of using AFKS within learning mathematical discovery in a classroom. Analysing the data received we tried to highlight the factors, which contributed to students' successful display in the process of learning mathematical discovery in a classroom, and obstacles of their work in the same process. Protocol sheets consisted of students' step by step description of their suggested actions, students' explanations of their preference for every action performed and teachers' commentaries on students' real actions and explanations. There were two evaluation columns for teacher's use only. The teachers used a dual code of  $\{0, 1\}$  for marking students' progress in both evaluation cases. The first one concerned *students' explanations* about the reasons why they used a certain suggestion or carried out a certain action on each step of the task. The teachers evaluated students' explanation with 1, if it was logically presented using appropriate argumentation. In the opposite case the corresponding explanation was marked with 0. In the second case teachers dealt with *students' actual suggestion or action* on each step of the task. They evaluated students' actual suggestion or action with 1, if teachers accepted it had been logically performed, even in the case when students were not able to provide satisfactory explanation for their decision. Again, in the opposite case the corresponding suggestion or action was marked with 0. For calculation  $I$  of each student for a certain task we used a formula of elementary probability for the finite number of events (in our terminology steps):  $I = \frac{\sum 1}{N}$ , where  $N$  was a number of steps for a certain task.

## THE CASE OF TEN STUDENTS

Now we would like to characterise briefly three different forms of learning mathematical discovery in a classroom with presentation data received and findings of the research. These forms had been used for quantitative and qualitative evaluation in Phases 1, 2 and 3 correspondingly. It is important to stress that we have paid great attention and rigour to the procedure of phase tasks selection. In Phase 1 we used students' individual work on protocol sheets without help of a teacher. Phase 2 consisted of students' collaborative work in pairs with help of a teacher. There was one protocol sheet for a pair of students for each task. In Phase 3 we used students' individual work again, but with the help of a teacher.

### Phase 1

Gray et al. (1999) pointed out that "didactical reversal - constructing a mental object from 'known' properties, instead of constructing properties from 'known' objects causes new kinds of cognitive difficulty" (p.117). We used the idea of "didactical reversal" for our tasks at this stage. We called it *didactical chronology of discovery*, i.e. we proposed students to build up a successive chain of their argumentation, which would lead them to the revealing of a certain property. A characteristic feature of our

tasks was the condition that a property and its full proof were included in the body of the tasks and were available for students' studying from the first moment of their work on the tasks. Two tasks of this phase were devoted to discovery of a circle of nine points and Euler line correspondingly. The main peculiarity of Phase 1 was the fact that students needed to explain the ideas and actions, which had been proposed by another person (e.g. famous Euler).

## Phase 2

Main components of the second phase of the research were open problems and the help of a teacher, who was a guarantee for creating environment suitable to exploration and inquiry work. Thus, a teacher was a person, who had to regulate directions of students' inquiry work in the process of learning mathematical discovery and adapt it to the classroom needs. For open problems proposed for students we followed Arzac et al (1988) characterisation of:

The statement of the problem is short, so that it can be easily understood, it fosters discovery and all students are able to start the solution process. The statement of the problem does not suggest the method of solution, or the solution itself, but it creates a situation stimulating the production of conjectures. The problem is set in a conceptual domain, which students are familiar with. Thus, students are able to master the situation rather quickly and to get involved in attempts of conjecturing, planning solution paths and finding counter-examples in a reasonable time.

We called this phase *learning discovery within open problem*. Taking into account that the illumination stage of mathematical discovery is accompanied by a feeling of certainty (Poincaré, *ibid.*) and positive emotions (Burton, *ibid.*; Rota, 1997) it was teachers' responsibility to manage a process of learning mathematical discovery. In other words, building up and supporting the corresponding learning environment aimed at the conditions for the best display of students' abilities in the process of mathematical discovery was the chief objective of teacher's work at this phase. At the same time we took into account that "open problems promote the devolution of responsibility from the teacher to students" (Furinghetti & Paola, 2003, p.399). Two tasks of this phase concerned discovery of different properties for Brocard and Lemoine points.

## Phase 3

Following Brown and Walter (1990) we proposed "situation", an issue, which was a localised area of inquiry with features that can be taken as given or challenged and modified. We called this phase *learning discovery over situation*. We would like to note that there were different directions of students' inquiry work in this phase. To control situation by the teachers we used Mercer's idea (1995) of "the sensitive, supportive intervention of a teacher in the progress of a learner, who is actively involved in some specific task, but who is not quite able to manage the task alone". Situations for two tasks of this phase were based on Simson line and Morley triangle properties. It is important to stress it was more generalised phase than the first two ones.

## Findings

We processed 60 protocol sheets (20 ones for each phase), 5 of them had not been completed (1 sheet of the Phase 1, 1 sheet of the Phase 2 and 3 sheets of the Phase 3 correspondingly). Generalised data are given in Table 1 below.

The process of learning mathematical discovery in a classroom	1 <sup>st</sup> Task		2 <sup>nd</sup> Task		Average $I$ on the base of students'		Character of the process on the base of students'	
	Evaluation $I$ on the base of students'		Evaluation $I$ on the base of students'		on the base of students'		of students'	
	explanations	actions	explanations	actions	explanations	actions	explanations	actions
Phase 1	0,81- 0,86	0,83- 0,94	0,78- 0,89	0,87- 0,97	0,84	0,91	logical	logical
Phase 2	0,7- 0,86	0,81- 0,89	0,71- 0,84	0,79- 0,91	0,78	0,86	non-logical	logical
Phase 3	0,72- 0,79	0,79- 0,91	0,69- 0,81	0,8- 0,89	0,76	0,84	non-logical	logical

Table 1: Data of quantitative and qualitative characteristics of the process

Values of  $I$  on the left side of the table indicate the limits, in which  $I$  changed for a certain task on a certain phase of the study, e.g. on the Phase 1 values  $I$  of all students for the 2<sup>nd</sup> Task on the base of their actions were from 0,87 (the worst result) to 0,97 (the best result). In the case of obtaining average value of  $I$  close to 1 either on the base of students' explanations or students' actions on a certain phase of the study, we could state about logical character of the process. The number of steps in the proposed tasks was up to 10, therefore empirically we considered the character as non-logical, if more than one step of the task was evaluated as non-logical (with mark 0). Thus, we decided to define the character of such process as non-logical, if  $I \leq 0,8$ . Of course, it requires further discussion and specification. However, the most important results are the values of  $I$  for the corresponding phases. They indicate the tendency that illumination stage diminishes to 0 in the scope of the process of learning mathematical discovery in a classroom.

We have found out that logical processes of deductive and inductive reasoning play significant role within the three different forms of the process, which were considered in the study. We can construct a set of key tasks with indicated in advance quantitative scale of using extra-logical processes in students' inquiry activities in learning mathematics. Thus, we can distinguish and regulate the illumination stage of mathematical discovery within *learning mathematical discovery*, we can adapt it to the needs of classroom activities or to the thinking process of a certain student

involved in these activities. We would like to stress the crucial meaning of the students' successful work on the first phase of the study. Despite the apparent simplicity of the tasks, we observed that students experienced other kinds of cognitive difficulty than on the stage of studying a property and its proof. We had the similar situation in the third phase of the study, however, in the conceptual context. We observed that students commented, argued and explained thoughts and ideas of other students, teachers and mathematicians (e.g. see the task of famous Euler above) much better than their own suggestions. Therefore, non-logical character of the process on the base of students' explanations for the second and third phases was connected, first of all, with semantic difficulties of students, when they were to communicate with others using symbolic and usual language simultaneously, often some of the best students could not express their thoughts in a correct way or quite clearly. At the same time teachers' observations and short students' interviews showed much more students' interest in the second form of learning mathematical discovery than in others. It emphasized the role of a teacher in managing this process. In our study we presented a teacher as a provider of knowledge on a foreseen in advance level, who was able to regulate the illumination stage of students' mathematical discovery additionally to the tasks proposed. Though, we found out that students only intuitively differ logical and extra-logical processes in learning mathematical discovery, their opinion was practically unanimous that teacher's contribution to students' successful work was invaluable. This tendency was confirmed with the least differences of changing  $I$  in Phase 2, i.e. students intuitively felt that teachers most of all contributed to development of their skills to explain logically their ideas and actions based on logical process of deductive and inductive reasoning. In all tasks of the forms of learning mathematical discovery we distinguished key didactical situations, which we called *hills of discovery*. Students' success or fail in each phase task depended mainly on their abilities to go through these hills of discovery. From our point of view they were additional regulators of using extra-logical processes in students' inquiry activities in a classroom.

## References

- Arsac, G., Germain, G. & Mante, M. (1988). *Problème ouvert et situation-problème*. IREM, Villeurbanne.
- Barnes, M. (2000). 'Magical' moments in mathematics: Insights into the process of coming to know. *For the Learning of Mathematics*, 20(1), 33-43.
- Brown, S. I. & Walter, M. I. (1990). *The art of problem posing*. Mahwah, New Jersey: LEA.
- Burton, L. (1999). The practices of mathematicians: What do they tell us about coming to know mathematics? *Educational Studies in Mathematics*, 37(2), 121-143.
- Devlin, K. (2000). *The Maths Gene: Why everybody has it, but most people don't use it*. London: Weidenfeld & Nicholson.
- Edwards, L. (1997). Exploring the territory before proof: Students' generalizations in a computer microworld for transformation geometry. *International Journal of Computers for Mathematical Learning*, 2, 187-215.

- Furinghetti, F. & Paola, D. (2003). To produce conjectures and to prove them within a dynamic geometry environment: A case study. In N. A. Pateman, B. J. Doherty, & J. Zilliox (Eds.), *Proc. 27<sup>th</sup> Conf. of the Int. Group for the Psychology of Mathematics Education* (Vol. 2, p. 397-404). Honolulu, USA: PME.
- Gray, E., Pinto, M., Pitta, D., Tall, D. (2000). Knowledge construction and diverging thinking in elementary and advanced mathematics. *Educational Studies in Mathematics*, 38, 111-133.
- Hadamard, J. (1945). *The psychology of invention in the mathematical field*. Princeton University Press.
- Krutetskii, V. A. (1976). *Psychology of mathematical abilities in schoolchildren*. In J. Kilpatrick & I. Wirszup (Eds.), J. Teller (Transl.), Chicago and London: The University of Chicago Press.
- Lakatos, I. (1976). *Proofs and refutations: The logic of mathematical discovery*. Cambridge: CUP.
- Liljedahl, P. (2004). Mathematical discovery: Hadamard resurrected. In M. J. Høines & A. B. Fuglestad (Eds.), *Proc. 28<sup>th</sup> Conf. of the Int. Group for the Psychology of Mathematics Education* (Vol. 3, pp. 249-256). Bergen, Norway: PME.
- Okada, T. & Simon H. A. (1997). Collaborative discovery in a scientific domain. *Cognitive Science*, 21(2), 109-146.
- Poincaré, H. (1952). *Science and method*. New York, NY: Dover Publications, Inc.
- Polya, G. (1962). *Mathematical discovery*. New York: John Wiley & Sons.
- Rota, G. (1997). *Indiscrete thoughts*. Boston, MA: Birkhauser.
- Sinclair, N. (2002). The kissing triangles: The aesthetics of mathematical discovery. *International Journal of Computers for Mathematics Learning*, 7(1), 45-63.
- Tall, D. (1980). The anatomy of a discovery in mathematics research. *For the Learning of Mathematics*, 1(2), 25-34.
- Yevdokimov, O. (2003). Intuitive proofs as a tool for development of student's creative abilities while solving and proving. In N. A. Pateman, B. J. Doherty, & J. Zilliox (Eds.), *Proc. 27<sup>th</sup> Conf. of the Int. Group for the Psychology of Mathematics Education* (Vol. 1, p. 264). Honolulu, USA: PME.



# DEVELOPMENTS OF A CHILD'S FRACTION CONCEPTS WITH THE HELP OF PSYCHOLOGICAL TOOLS: A VYGOTSKY'S CULTURAL-HISTORICAL PERSPECTIVE

Kaori Yoshida

Nagasaki University

*This paper aims to interpret Vygotsky's abstract theory in a concrete mathematical context. Based on cultural-historical perspective Vygotsky stresses the importance of psychological tools in the development of human behavior. Through the interviewing and observing fraction lessons the researcher draws two conclusions: Both of the learning material and the fraction symbols function as psychological tools but they have difference in some levels; Kanako, a third grader, developed concepts of equivalent fractions mediated by fraction signs in a class, but it is not a real concept.*

## VYGOTSKY'S CULTURAL-HISTORICAL PERSPECTIVE

According to Van der Veer and Valsiner (1991), Vygotsky's cultural-historical theory aimed at exploring where mental processes originated from and how they developed. In fact, Vygotsky and Luria (1930/1993) placed a great emphasis on "historical development" of human behavior, not only on "biological evolution" and "childhood development" (p.81). Based on four comparisons between behaviors of lower and higher forms such as between anthropoid apes and human beings (Van der Veer & Valsiner, 1991), Vygotsky and Luria (1930/1993) drew the following conclusions in reference to works of Köhler, Bühler, Engels, Lévy-Bruhl and so on (Yoshida, 2004a).

As regards nature, chimpanzees purely *use nature* with no intention, using tools as auxiliary. To make and use tools are inessential to survival for them. Using tools of labor, on the other hand, human beings *control nature* in accordance with their ends and plans. Hence these tools are essential to living for human.

Furthermore, regarding with psychological development, nonverbal communication and thought describe chimpanzees' behaviors whereas human beings invent artificial signs and behave relying on such signs and speech. This means that human beings *control their behavior itself using signs*. In short, Vygotsky recognized that the human ability to control behavior through sign systems was the key difference between anthropoid apes and humans.

Incidentally, what does it mean to control human behavior through sign systems? Vygotsky and Luria (1930/1993) illustrated it with comparisons between behaviors of *natural* people and *cultural* people. According to Roth, for instance, messengers of the North Queensland aborigines delivered a song repeating it from memory even though it took five nights to finish (as cited in Lévy-Bruhl, 1910/1966, p.94).

Vygotsky gave an explanation of this as eidetic memory – an undifferentiated whole consisting of perception and memory – which people do *not control* but merely *use*.

Along with historical development of human beings, mnemotechnical aids became popular (Vygotsky & Luria, 1930/1993). For example, knot-based mnemotechnical systems for memorizing, or “quipu” were used to record important events or results of counting the number of animals (cf. p.104). Likewise, in Okinawa islands of Japan officers used to tie and interpret knots in a rope when collecting taxes (Ifrah, 1981/1988). And finally, human invented signs and letters for writing.

In conclusion, as sign systems developed, humans started to keep records with the help of mnemotechnical aids of knots and signs. In other words, human beings were freed from enormous amount of memories. As a result, it enabled humans to think abstractly, hypothetically, and logically (Vygotsky & Luria, 1930/1993). And this means that human beings control their behavior with the help of artificial signs.

## PSYCHOLOGICAL TOOLS

We have many reasons to assume that the cultural development consists in mastering methods of behavior which are based on the use of signs as a means of accomplishing any particular psychological operation. (Vygotsky, 1929, p.415)

This Vygotsky’s description represents that self-control over behavior through sign systems is “the essence of the cultural development of man’s behavior” (Vygotsky & Luria, 1930/1993, p.77). In this context *culture* has a special meaning for Vygotsky. As Van der Veer and Valsiner (1991) pointed out, using Barash’s distinction of a cultural evolution, Vygotsky identified culture as sign systems – writing systems, counting systems, and language.

Such sign systems – the key to a cultural-historical development of human behavior – are explained as psychological tools by Vygotsky. Psychological tools are artificial instruments directed toward control over human behavior and they are the products of historical development of human behavior (Vygotsky, 1930/1997).

While natural memorization produces a direct associative connection A–B between stimuli A and B (see Figure 1), a psychological tool X makes a new path from A → X → B (Vygotsky, 1929, 1930/1997). At this time, X can play the *role of the object* which an act of behavior (ex. to memorize, to choose) for problem solving is directed toward and the *role of a means* of the psychological operations (ex. memorizing, comparing) to solve the problem.

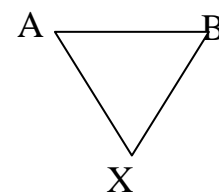

Figure 1: Schematic Triangle (Vygotsky, 1930/1997)

Moreover, psychological tools are differentiated from technical tools because the technical tools change the object itself while the psychological tools effect no change in the object but influence human behavior or mind.

This could be explained using the example of the officers in Okinawa islands shown in the above as follows: To record taxes the officers tie knots and to report the taxes

they interpret the knots, and here the knots are the object of their acts. In addition, the knots play the role of a means that enables the officers to reach their objectives. Furthermore, the knots do not change the rope but change the officers' behavior.

Although the discussion given above is important theoretically, for mathematics educators it is more important to reinterpret it in a context of a real world on mathematics education. Thus, the researcher presents the following surveys and notes on lesson observations to consider development of a child's fraction concepts with the help of psychological tools.

## A SERIES OF RESEARCHES ON KANAKO'S FRACTION CONCEPTS

### Survey 1 and survey 2 by interviewing: Before and after fraction lessons

The surveys 1 and 2 for six third graders were conducted respectively in January and March 2000 (Yoshida, 2000b, 2001, 2002). The purposes of the surveys were to clarify children's *everyday concepts* of fractions and to identify how children's concepts develop before and after fraction lessons.

Kanako, one of the children, solved each problem first by herself while the researcher was observing her problem solving activity, and then was interviewed. The problems given in the surveys before and after the fraction lessons were almost the same, but only the latter survey included a number line problem.

The first problem was to make a classification and a characterization. In fact, in the survey 1 Kanako classified seven figures and sentences into two groups according to features that they have in common, and named the groups "1 out of 3" and "2 out of 6."

In the survey 2, after learning fractions in classes, she classified them into two groups at first and named them "1/3" and "2/6." After interviewing her about the idea, the researcher asked if it would be possible to reduce the number of groups she classified into.

Researcher: ... What do you think if you can reduce the number of the groups you categorized into?

... (omission of some sentences by several people)

Kanako: I think it is OK to put the two groups together in one.

Researcher: Why do you think so?

Kanako: Well, because when 1/3 is marked with an additional scale, it turns out 2/6. Again, it gets bigger and bigger. ... why I separated this (group of 1/3) from that (group of 2/6) is because the numbers for dividing were different from one another. ...

Researcher: What kind of name do you give to the new group you made?

...

Kanako: a group of '1/3 transformed into 2/6' and '2/6'

The second problem was to draw a picture showing “one fourth” and to describe a meaning of “one half” with words. Kanako gave Figures 2 and 3 respectively before and after the fraction lessons.

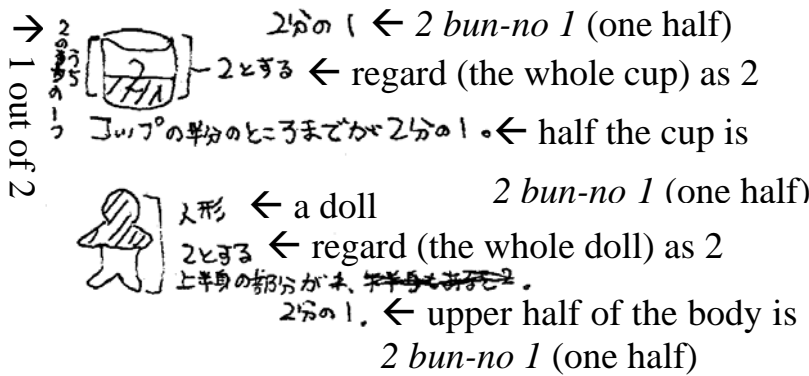

Figure 2: One half as “1 out of 2.”

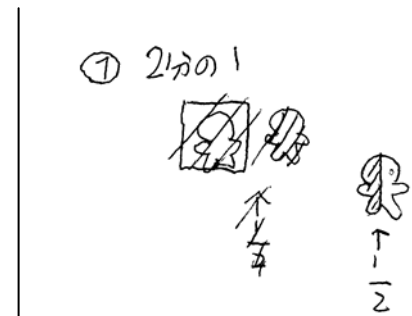

Figure 3: One half as “half a whole.”

The third problem was to mark  $4/10m$ ,  $1/2m$ , and  $2/5m$  on a number line. Rika, one of the subjects in the surveys, gave an incorrect answer (see Appendix A) while Kanako gave a correct one (see Appendix B).

### Observation on fraction lessons

A series of five fraction lessons for 39 third graders, including the six subjects in the surveys, were observed on March 1 – 7, 2000 in Hiroshima, Japan (Yoshida, 2002). Because of the official curriculum guidelines of that time, it was the first time for them to take fraction classes at school. A teacher specialized in mathematics set the following situations where children could learn fractions appropriately, according to his teaching experience.

In the first lesson, the teacher cut a piece of pink ribbon in two in front of the children and told them that the longer ribbon was 1m long. He asked how long the shorter one was. Through the lesson, they found out that triple of the length of the shorter ribbon was equivalent to that of the longer one. Moreover, a child raised a question; What would you do if the shorter ribbon did not correspond to the longer one entirely?

Therefore, in the second lesson the teacher asked the children to find out the length of a piece of new blue ribbon (45cm long) comparing to the longer pink ribbon (1m long) given in the first lesson. Through this lesson, the children realized that in this case it was the best way to fold the pink ribbon graduated in 1m. In short, they changed the benchmark for comparing from the ribbon in which the length was unknown to the ribbon with 1m-length.

In the next lesson, the teacher gave glass-shaped folding papers and asked, “This is a liter glass. How much juice is left in the glass?” Since the children had lots of experience of folding in the previous lesson, they started to solve this problem by folding the papers in some ways (see Figure 4). Through the folding activities, they found out that they could tell the amount of the juice in some ways depending on how many times they folded the paper. That means, some children gave the answer “2 out

of 5 parts” while the other did “4 out of 10.” After that, the teacher introduced a sign of fractions such as  $\frac{2}{5}$  and  $\frac{4}{10}$ .

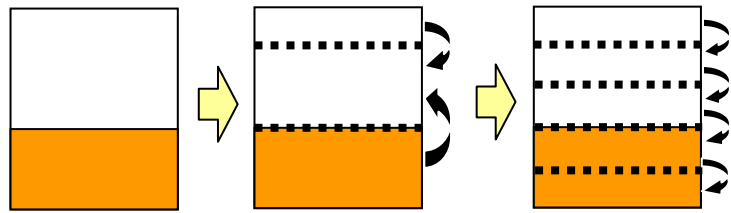

Figure 4: Glass-shaped folding papers.

The fourth lesson started with the same problem, but the amount of juice shaded on a glass-shaped folding paper was  $\frac{3}{5}$  liter. The focus of the children’s interests changed from how to fold in the previous class to how to express the amount of the juice in this lesson, i.e.  $\frac{6}{10}$  l vs.  $\frac{6}{10}$  dl. Through an in-depth discussion on the issue, they achieved a consensus that it could be represented as  $\frac{6}{10}$  l and  $\frac{3}{5}$  l. The following conversation took place shortly after that.

Kazuo: Mr., you can make it more, endlessly.

... (omission of some sentences by several people)

Kanako: Um, I got started with  $\frac{3}{5}$ , and then,  $\frac{6}{10}$ ,  $\frac{9}{15}$ , ...

Teacher:  $\frac{9}{15}$ ? Wait. Just a second. I’m going to write them down here on the blackboard.  $\frac{3}{5}$ ,  $\frac{9}{15}$ ,

...

Teacher:  $\frac{12}{20}$ . Ha! Ha! [while he is writing it down.]

Kanako:  $\frac{15}{25}$ ,  $\frac{18}{30}$ , ...

At the end, Kanako notified that she gained  $\frac{300}{500}$ , and so the other children looked into her notebook (see Appendix C) surrounding her desk.

## DISCUSSION

The research suggests two findings as follows based on Vygotsky’s theory.

First, we could regard both of the glass-shaped folding papers in the third lesson and fraction signs introduced in the fourth lesson as psychological tools to recognize the system of equivalent fractions, because both of them play the *role of a means* by which Kanako and the other children produced the idea of equivalent fractions as well as play the *role of the object* of their acts such as folding papers (to find out the amount of juice) and making fractions (to express the amount of juice in a variety of ways).

However, it is possible to distinguish the levels of the glass-shaped folding papers and fraction signs one another. That means the children and the officer who collected taxes depend on the concrete contexts using the glass-shaped folding papers and the knots, so that they cannot think and cannot solve their problems without the tools. On the other hand, after the teacher introduced the signs of fractions, Kanako developed expressions of equivalent fractions on her own motive without any concrete materials and not based on any practical situations. In short, the fraction signs as psychological tools could lead Kanako to a general, hypothetical, and/or abstract thinking and the ability of planning for the future. This corresponds with the following descriptions.

With the aid of speech the child for the first time proves able to the mastering of its own behaviour, relating to itself as to another being, regarding itself as an object. Speech helps the child to master this object through the preliminary organization and planning of its own acts of behaviour. (Vygotsky & Luria, 1930/1994, p.111)

Second, we could conclude that Kanako's fraction concepts developed with the aid of psychological tools, i.e. fraction signs, through the lessons. For example, she modified her views on "one half" from "1 out of 2" (see Figure 2) to "half a whole" (see Figure 3). As Rika gave a wrong idea in the number line problem (see Appendix A), the idea of "1 out of 2" corresponding to each number of numerator and denominator for  $1/2$  is one of *everyday concepts* for fractions and causes the difficulty of learning fractions (cf. Yoshida, 2002, 2004b).

In addition, Kanako showed a remarkable development of fraction concepts in which she produced equivalent fractions from  $3/5$  to  $300/500$  during a class. However, the products made by Kanako (i.e. Appendix C) should be investigated with special attention because those equivalent fractions were probably made by adding 3 to the numerator and adding 5 to the denominator like  $15/25 = (15+3)/(25+5) = 18/30$ , instead of multiplying the numerator and denominator of  $3/5$  by 6, taking her age (or her ability) and the hours of the lesson into account.

Such Kanako's thinking for equivalent fractions are regarded as *pseudoconcept* (Vygotsky, 1934/1987). In appearance a pseudoconcept and a real concept look alike, yet in reality a pseudoconcept is one of thinking in *complexes*, and besides it is in the highest level among five different types of complex (cf. Yoshida, 2000a). Sierpinska (1993) gives an example of the pseudoconcept in mathematics as follows: Children may select every triangle in similar manner to adults; however, it is based on the physical appearance of triangles and not based on a definition of a triangle.

As Berger (2005) describes, pseudoconcepts can lead "the transition from complexes to concepts" (p.158); in addition to this, children can communicate with adults and other advanced people because of pseudoconcepts. Therefore, it is regarded that a pseudoconcept takes an important role when children's concepts or thinking develop. In fact, the teacher communicated with Kanako in the class as if she could have understood equivalent fractions properly. Yet the results of the first problem in the surveys 1 and 2 showed that Kanako's thinking of equivalent fractions was not enough to reach a real concept because Kanako combined the group of  $1/3$  and  $2/6$  only after the researcher asked if it would be possible.

**Acknowledgements** This research was supported by grants from the Japan Society for the Promotion of Science. The support is gratefully acknowledged.

## References

Berger, M. (2005). Vygotsky's theory of concepts formation and mathematics education. In H. L. Chick & J. L. Vincent (Eds.), *Proceedings of the 29th Conference of the International Group for the Psychology of Mathematics Education [PME]* (Vol.2, pp.153-160). Melbourne, Australia.

- Ifrah, G. (1988). *Suji no rekishi: Jinrui ha su wo donoyouni kazoete kitaka* [Universal history of numbers] (M. Yorinaga, M. Maruyama, & T. Gohira Trans.). Tokyo: Heibonsha. (Original work published 1981)
- Lévy-Bruhl, L. (1966). *How natives think* (L. A. Clare Trans.). New York: Washington Square Press. (Original work published 1910)
- Sierpinska, A. (1993). The development of concepts according to Vygotski. *Focus on Learning Problems in Mathematics*, 15(2&3), 87-107.
- Van der Veer, R. & Valsiner, J. (1991). *Understanding Vygotsky: A quest for synthesis*. Cambridge, MA: Blackwell.
- Vygotsky, L.S. (1929). II. The problem of the cultural development of the child. *The pedagogical seminary and journal of genetic psychology*, 36(3), 415-434.
- Vygotsky, L. S. (1987). Thinking and speech (N. Minick, Trans.). In R.W. Rieber & A. S. Carton (Eds.), *The collected works of L.S. Vygotsky: Volume 1 problems of general psychology* (pp.39-285). New York: Plenum Press. (Original work published 1934)
- Vygotsky, L. S. (1997). The instrumental method in psychology (R. Van der Veer, Trans.). In R. Rieber & J. Wollock (Eds.), *The collected works of L.S. Vygotsky: Volume 3 problems of the theory and history of psychology* (pp.85-59). New York: Plenum Press. (Original work reported 1930)
- Vygotsky, L. S. & Luria, A. R. (1993). *Studies on the history of behavior: Ape, primitive, and child* (V. I. Golod & J. E. Knox, Eds. & Trans.). Hillsdale, NJ: Lawrence Erlbaum Associates. (Original work published 1930)
- Vygotsky, L. S. & Luria, A. R. (1994). Tool and symbol in child development. In R. Van der Veer, R. & J. Valsiner (Eds.), *The Vygotsky reader* (pp.99-174). Cambridge, MA: Blackwell. (Original manuscript written 1930)
- Yoshida, K. (2000a). Sugaku kyouiku ni okeru Vygotsky no “gainen hattatsu no dankai” ron no kousatsu [Vygotsky’s “theory of concept development” in mathematics education]. *Annals of Educational Research*, 45(2), 275-280.
- Yoshida, K. (2000b). Vygotsky no “hukugou-teki-sikou no dankai” ni motodoku bunsu no seikatsu-teki-gainen no kousatsu: rengou-teki-hukugou wo chusin to shite [On everyday concepts of fraction based on “complexive thinking” by Vygotsky: Focusing on associative complex.]. *Journal of Japan Academic Society of Mathematics Education: Research in Mathematics Education*, 6, 139-148.
- Yoshida, K. (2001). Vygotsky riron ni motodoku bunsu ni taisuru kodomo no gainen-henyou no bunseki [An analysis of children’s concept developments for fractions based on Vygotsky theory]. *Annals of Educational Research*, 46(2), 237-242.
- Yoshida, K. (2002). *Vygotsky riron wo kiban to suru kodomo no bunsu-gainen no keisei to gakusyuu ni kansuru kenkyuu* [A research on the formation and learning of fraction concepts by children based on Vygotskian theory]. Unpublished doctoral dissertation, Hiroshima University, Japan.
- Yoshida, K. (2004a). *Why the “cultural-historical” perspective is an essential part of Vygotsky’s theory*. Paper presented at Jean Piaget Society 34th Annual Meeting, Toronto, Canada.

Yoshida

Yoshida, K. (2004b). Understanding how the concept of fractions develops: A Vygotskian perspective. In M. J. Høines & A. B. Fuglestad (Eds.), *Proceedings of the 28th Conference of the International Group for the PME* (Vol.4, pp.473-480). Bergen, Norway: PME.

**Appendix A: Rika's number line problem solving.**

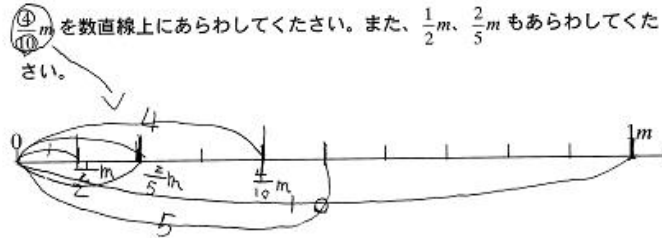

**Appendix B: Kanako's number line problem solving.**

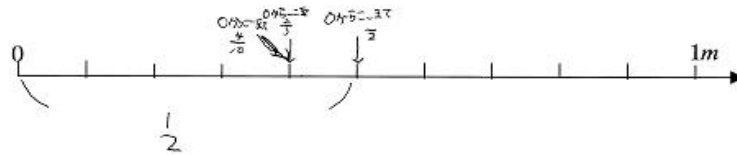

**Appendix C: Kanako created fractions starting with 3/5, on her own motive.**

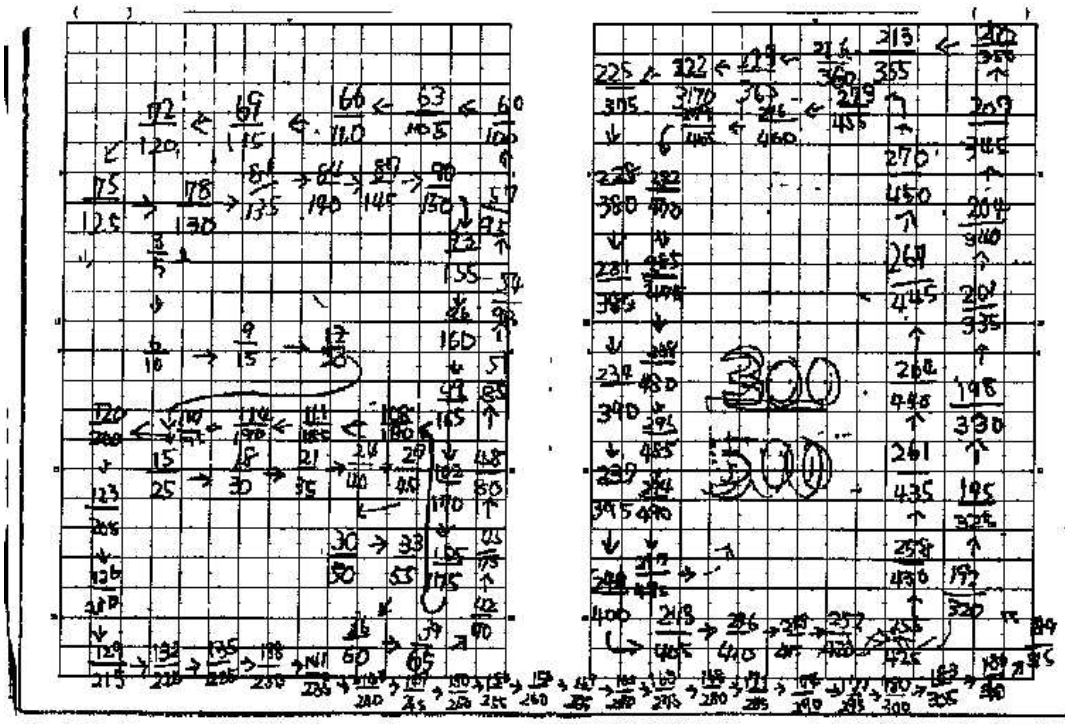



# A TEACHER'S TREATMENT OF EXAMPLES AS REFLECTION OF HER KNOWLEDGE-BASE<sup>1</sup>

Orit Zaslavsky

Technion – Israel Institute of Technology, Haifa

Guershon Harel and Alfred Manaster

University of California, San Diego

*In this paper we present an approach to examining teachers' practice by focusing on one teacher's choice and use of examples in her lesson. By analysing and characterizing the teacher's treatment of examples, we are able to get a handle on significant aspects of her mathematical and content pedagogical knowledge-base that may support or limit students' learning.*

## EXAMPLES IN MATHEMATICS LEARNING AND TEACHING

Examples are an integral part of mathematics and an important component of expert knowledge (Michener, 1978). Examples play a critical role in learning, and in particular form the basis for generalization, abstraction and analogical reasoning. Studies on how people learn from worked out examples suggest that effective instruction should include multiple examples, with varying formats, that support the appreciation of deep structures rather than excessive attention to surface features (Atkinson et al, 2000). Studies related to concept learning suggest that examples and non-examples be introduced in a carefully thought way, to support the distinction between critical and non-critical features and the construction of a rich and appropriate concept image and example spaces (e.g., Vinner, 1983; Watson & Mason, in press; Zaslavsky & Peled, 1996). A number of studies deal with the contribution of carefully sequenced sets of examples on learning (e.g., Petty & Jansson, 1987). In spite of the critical roles examples play in learning and teaching mathematics, studies focusing on teachers' choice and treatment of examples are scarce. Rowland et al (2003) identify three types of elementary novice teachers' poor choices of examples, which concur with the concerns raised by Ball et al (2005) regarding the knowledge base teachers need in order to carefully select appropriate examples that are "useful for highlighting salient mathematical issues" (ibid). Clearly, the choice of examples in secondary mathematics is far more complex. Zaslavsky & Lavie (submitted) point to the possible complex web of considerations underlying teachers' choice of examples. In our study we illustrate the complexity of treatment of examples in an 8<sup>th</sup> grade pre-algebra course.

---

<sup>1</sup> This work is supported, in part, by the National Science Foundation (REC 0310128, G. Harel, M. Manaster PIs). Opinions expressed here are those of the authors and are not necessarily those of the Foundation.

## **TEACHERS' KNOWLEDGE BASE**

In our study we focus mainly on teachers' mathematical content knowledge and on their pedagogical content knowledge (Shulman, 1987). By pedagogical content knowledge we refer mainly to the teacher's knowledge of how to transform mathematics into forms that are "pedagogically powerful and yet adaptive to the variations in ability and background presented by the students" (ibid, p. 15). In particular, we regard examples as possible elements of pedagogically powerful tools for students to develop their ways of understanding and ways of thinking (Harel, in press). There is an interplay between the knowledge base that a teacher needs in order to construct powerful instructional examples (e.g., Ball et al, 2005) and the knowledge that is reflected through the use of examples. Our study is an attempt to deal with this interplay.

## **THE INTERPLAY BETWEEN TEACHERS' TREATMENT OF EXAMPLES AND THEIR KNOWLEDGE BASE**

A teacher's treatment of examples in the classroom can reveal a critical aspect of the proof schemes they possess as well as the proof schemes they target for their students. Specifically, a teacher may use a sequence of examples to help students reveal an underlying pattern of a mathematical phenomenon. On the other hand, a teacher may use such a sequence as evidence for the truth of the phenomenon. These two teaching practices reflect fundamentally different ways of thinking: while the former is conducive to the deductive proof scheme, the latter to the empirical proof scheme (Harel, 2001). Later, in this paper, we demonstrate an application of the former practice by the teacher who participated in this study.

### **Framework and goals**

This paper is part of a series of reports, in progress, on the results of an NSF-funded project whose aim is to investigate the development of teachers' knowledge base under a particular instructional intervention, called DNR-based instruction (Harel, in press). The data reported in this paper is drawn from classroom observations of one of the ten teachers from a Southwestern U.S. urban area, who participated in this project. One segment of this research project focuses on identifying the teaching practices of the teachers who participated in the project and the alignment of these teaching practices with DNR. The study reported in this paper focuses on the teaching practices associated with the use of examples by teachers as a pedagogical tool<sup>2</sup>.

### **Procedure**

Three lessons of one of the teachers, Marjorie, who participated in the large study, were chosen. The first two we term "Lesson 1", since they were taught the same day

---

<sup>2</sup> This part of the study was inspired by and based on the conceptual framework of a research project funded by the Israel Science Foundation (grant 834/04, O. Zaslavsky PI) that investigates teachers' use of examples in mathematics.

separated only by lunch and addressed the same topic taught in Marjorie's first year in the project. The third lesson, which we term "Lesson 2", was taught a year later, on the same topic, to different students. These lessons were part of a pre-algebra course for 8<sup>th</sup> grade students in a low performing socioeconomically disadvantaged school. This was Marjorie's first year teaching mathematics.

As mentioned above, our approach for this portion of the study was to analyse the lessons from the point of view of the teacher's treatment of examples, in an attempt to find links to her knowledge-base. Thus, the lessons were divided into episodes according to their goal and main idea. Within each episode, the examples used were identified and characterized according to several constructs (e.g., the specific choice of examples; the sequence, range and variation among the specific cases; the type of examples used; the purpose the example served; the extent to which the example or set of examples may support the development of the mathematical idea). Some comparisons were drawn between the teacher's treatment of examples in the two lessons. Based on the previous stages, we identified elements of the teacher's knowledge-base that are reflected through her choice and treatment of examples. Finally, a stimulated recall interview was conducted with the teacher in order to validate or refute some conjectures that were raised regarding her considerations underlying her treatment of examples.

We turn to a description of Marjorie's treatment of examples in Lessons 1 & 2. The description is not complete or extendedly detailed, yet it depicts the main moves of Marjorie related to her choice and use of examples. This description conveys what Thompson (2005) terms the 'lesson logic'.

### Marjorie's treatment of examples in Lessons 1 & 2

#### Lesson 1:

Marjorie began the lesson by putting up front on the board three examples (Figure 1) leading to the formulae for the areas of a rectangle and a triangle. She moved from a rectangle and its area calculation – already familiar to her students, to a right triangle that is clearly half of the rectangle, to a more general triangle (not clear how generic it is). She kept the given measurements constant. This allows a better focus on the varying elements, e.g., the type of figure, the connection between a side and its corresponding height. Then, with the 'help' of some students that she invited to the board, she moved from one case to the next, building on the previous ones.

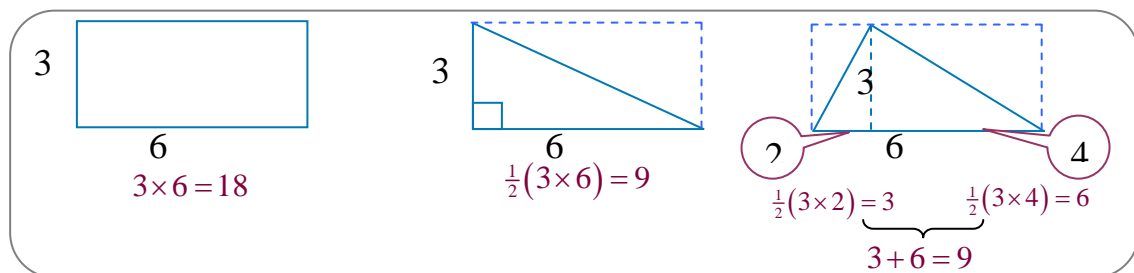

Figure 1: Marjorie's initial set of examples and calculations associated with each case

Figure 1 displays a fair account of what was written on the board at a certain point, after going through all three cases.

Note that in the third case – the more general triangle – the class discussed how they might ‘split’ the side of measurement 6. Following the majority of the suggestions, Marjorie split it into 2 and 4, and built on the previous case where there was a right triangle.

After establishing the way to calculate the area of a triangle, Marjorie presented the class with the topic of the lesson – the Pythagorean Theorem – and the general goal of the lesson, which was to find the relationship between the legs and the hypotenuse of a right triangle. The goal formulation created a need to introduce the notions of a right triangle and its legs and hypotenuse, which Marjorie did through some examples. Then she formulated a more specific question, related to the main goal of the lesson:

*Consider a right triangle with legs of length of 1. Suppose you draw squares on the hypotenuse and legs of the triangle. How are the areas of these three squares related?*

Figure 2 illustrates the teacher’s moves in constructing the squares in a way that the relationship between their areas would be obvious. She moved from constructing (on a grid transparency) a right triangle with the given legs, to constructing the squares on each leg, pointing to their area measurements; then constructed the square on the hypotenuse, using the grid to construct right triangles congruent to the given one. The final stage was to divide the square on the hypotenuse into parts, the area of which could be calculated. In this case it was done by sketching the two diagonals, and pointing to the congruence between the given triangle and the 4 ‘inner triangles’.

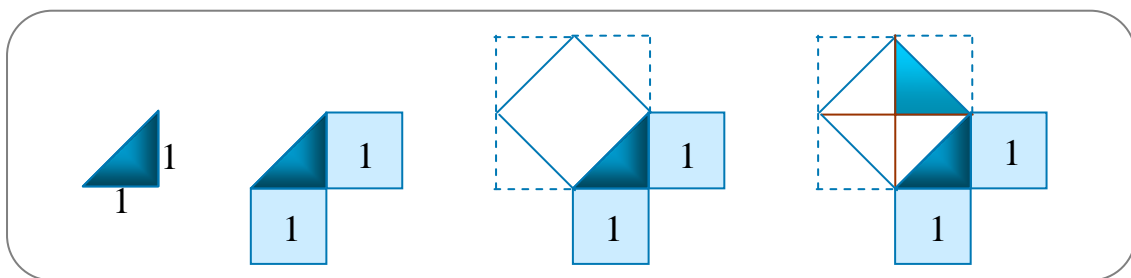

Figure 2: The sequence of constructions

Then the set of examples that Marjorie chose for illustrating of the relationship under investigation was presented in a form of a table (Table 1).

Having selected the specific cases for investigation, Marjorie used each one to illustrate not just the end result but the entire process leading to it, as illustrated in Figure 3 (for the first 4 examples). She repeated the reasoning for each step of the construction and accompanying calculations for all cases in Table 1, and filled the table with the data, pointing to the pattern that emerged from the process.

Length of Leg1	Length of Leg2	Area of Square on Leg1	Area of Square on Leg2	Area of Square on Hypotenuse
1	1			
1	2			
2	2			
1	3			
2	3			
3	3			
3	4			

Table 1: Specific cases for explorations through area considerations

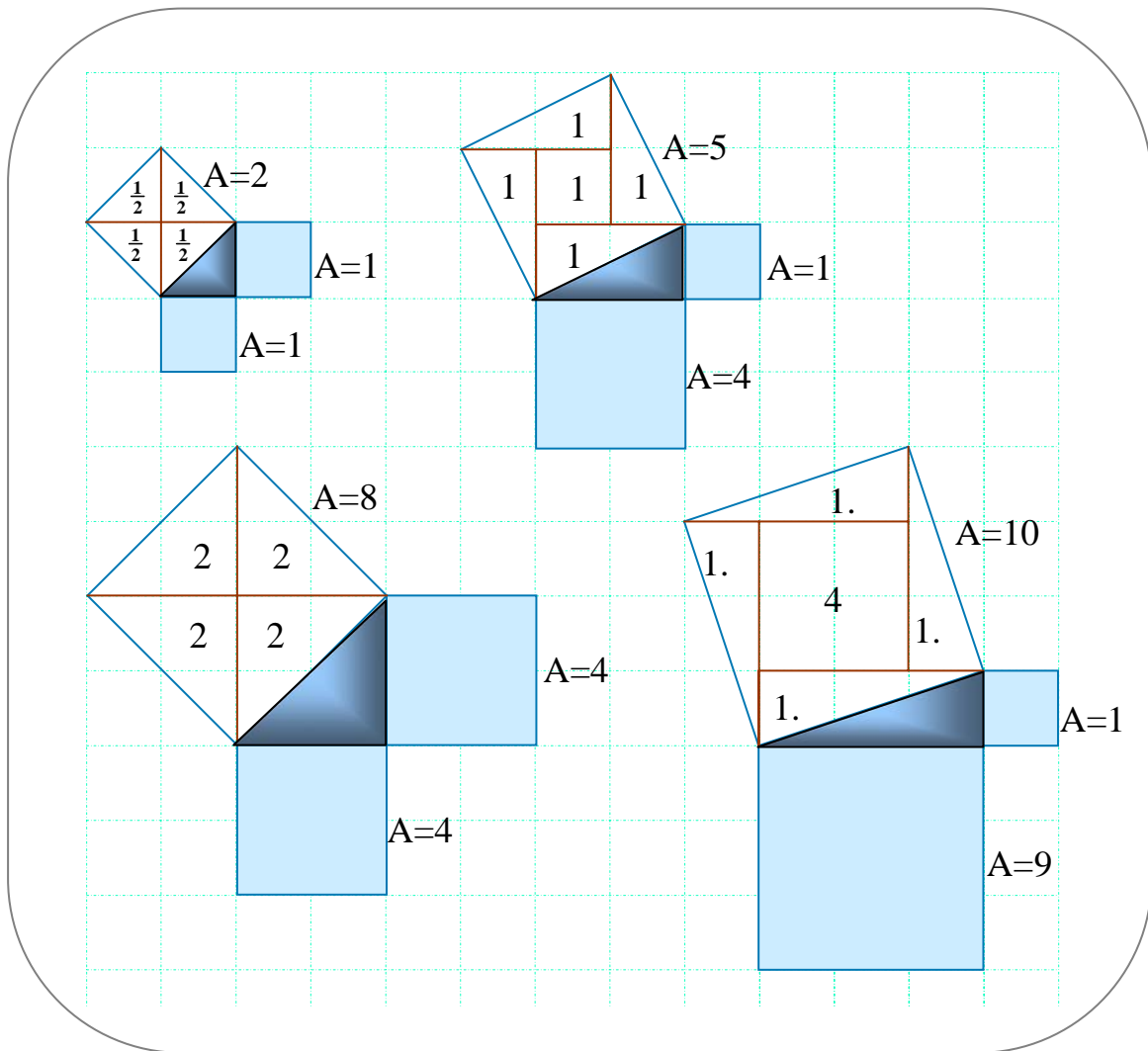

Figure 3: Repeated illustration of the process of obtaining the relationship between the areas of the squares on the sides of a right triangle, for the first 4 cases in Table 1 (A denotes Area)

Lesson 2:

This lesson began with an exploration task that stated the topic of the lesson, that is, the *Pythagorean Theorem* as follows (Figure 4):

Pythagorean Theorem

On graph paper, create right angle triangles with legs  $a$  and  $b$ . Measure the length of the 3<sup>rd</sup> side  $c$  with another piece of graph paper. Copy and complete the table below

$a$	$b$	$c$	$a^2$	$b^2$	$c^2$
3	4		9	16	
5	12		25	144	
9	12		81	144	

EXTENSION: Use  $<$ ,  $>$ , or  $+$  to complete:

Figure 4: The Exploration Task assigned to the students

Similarly to Lesson 1, the task created a need to introduce the notions of a right triangle and its legs and hypotenuse, which Marjorie also addressed in this lesson through some examples, although different than those in Lesson 1.

The lesson progressed as the students sketched the three right triangles on grid paper and measured their hypotenuses. Interestingly, they all came up with the ‘correct’ measure. Marjorie filled the two empty columns in the table on the board based on the data the students reported.

**THE TEACER’S KNOWLEDGE-BASE AS RELECTED BY HER TREATMENT OF EXAMPLES**

There are several elements of Marjorie’s knowledge-base that can be induced by examining her choice and use of examples in the two Lessons that were analysed. We allude to several of them and will elaborate on them further in our presentation. In our presentation we will also suggest links between Marjorie’s knowledge-base and the professional development framework in which she took part.

Looking at Lessons 1 & 2, in terms of the examples that Marjorie introduced, it is clear that she draws on her broad example-space and that she is flexible in her choices. Moreover, she is able to vary the examples she uses according to the lesson setting and approach she adapts. Thus, in Lesson 1, she applied an approach to the Pythagorean Theorem that is based on a process that can be justified and repeated for any right triangle. More specifically, this approach would work for any randomly chosen integer measures for the triangle legs (she needs the integers in order to be able to illustrate the construction on the graph paper). This is reflected in the large

number of cases they examine (7), and the systematic choice of these cases (1,1; 1,2; 2,2; 1,3; 2,3; 3,3; 3,4;). By this she conveys the generality of their conclusions. On the other hand, when she decides to use another approach as in Lesson 2 (for reasons that we later learned have to do with external constraints), she realizes that she can no longer select the examples freely. In order to make sure that the students can reasonably measure the hypotenuse with grid paper, she needs to make sure all sides are integers (while in Lesson 1 the hypotenuse could be a non-integer). Thus, she must rely on her knowledge of Pythagorean triplets. The constraints of the paper, allow her to make only a very limited number of examples (3), all very special cases. This approach does not convey a process and does not support the generalization. In short, the craft of carefully selecting examples seems to be part of Marjorie's knowledge-base, opposed to what Rowland et al (2003) report regarding unfortunate randomly chosen examples by novice teachers.

Through Marjorie's treatment of examples, a lot of her mathematical knowledge comes to play. In Lesson 1 she is very fluent in the way she demonstrates the construction that actually constitutes one of the visual proofs of the Pythagorean Theorem, based on the following equality:  $a^2 + b^2 = 4 \cdot \frac{1}{2}(a \cdot b) + (b - a)^2$ . It appears that even if Marjorie does not think of what she demonstrates in this symbolic form, she does see the general geometric pattern of the visual proof. On top of this sophisticated mathematical knowledge, Marjorie is familiar with some Pythagorean triplets and may even know how to generate a new triplet based on a known one, e.g.,  $(3,4,5) \Rightarrow (3 \cdot 3, 3 \cdot 4, 3 \cdot 5)$ .

From the analysis of Marjorie's treatment of the initial set of examples (Figure 1), it appears that she understands to a certain extent the invariance of area of triangles with a given side and the corresponding height. Thus, when splitting the side in the 3<sup>rd</sup> example, she used the wording "call this 2 and call this 4". So to her it is just a placeholder and could work for any other way of splitting it (we validated this interpretation in the stimulated recall interview).

In spite of her rather deep mathematical knowledge related to the topic she taught and of many manifestations of attentiveness to students and sensitivity to their ways of learning, Marjorie also manifested some missed or even mis-leading opportunities. For example, in the case of the invariance of triangle area – although she was careful in her wording – this most probably did not come across to the students. Trying out other possible splits and realizing that the area remains the same could have been more supportive.

To conclude, characterising Marjorie's treatment of examples and using it as a means to learn about her knowledge-base appears to be both feasible and worthwhile in terms of the complexity and richness it conveys. Through her treatment of examples we were able to get a handle on significant aspects of her mathematical and content pedagogical knowledge, along the lines of Ball et al (2005). The approach suggested in this paper concurs with Hiebert et al's ideas of learning from practitioners (2002).

## References

- Atkinson, R. K., Derry S. J., Renkel A., & Wotham, D. (2000). Learning from Examples: Instructional Principles from the Work-Out Examples Research. *Review of Educational Research*, 70(2), 181-214.
- Ball, D., Bass, H., Sleep, L. & Thames, M. (2005). A Theory of Mathematical Knowledge for Teaching. Paper presented at a Work-Session at the 15<sup>th</sup> ICMI study conference on The Professional Education and Development of Teachers of Mathematics, Brazil.
- Harel, G. (In press). The DNR System as a Conceptual Framework for Curriculum Development and Instruction. In R. Lesh, J. Kaput, & E. Hamilton (Eds.), *Foundations for the Future in Mathematics Education*. Erlbaum.
- Harel, G. (2001). The Development of Mathematical Induction as a Proof Scheme: A Model for DNR-Based Instruction. In S. Campbell & R. Zaskis (Eds.), *Learning and Teaching Number Theory* (pp. 185-212). Ablex Publishing Corporation.
- Hiebert, J., Gallimore, R., & Stigler, J. W. (2002). A knowledge base for the teaching profession: What would it look like and how can we get one? *Educational Researcher*, 31(5), 3-15.
- Michener, E. R. (1978). Understanding Understanding Mathematics. *Cognitive Science*, 2, 361-383.
- Petty, O. S., & Jansson, L. C. (1987). Sequencing Examples and Nonexamples to Facilitate Concept Attainment. *Journal for Research in Mathematics Education*, 18(2), 112.
- Rowland, T., Thwaites, A. & Huckstep, P. (2003). Novices' Choice of Examples in the Teaching of Elementary Mathematics. In A. Rogerson (Ed.), *Proceedings of the International Conference on the Decidable and the Undecidable in Mathematics Education*. (pp. 242-245). Brno, Czech Republic.
- Shulman, L. (1987). Knowledge and teaching: Foundations of the new reform. *Harvard Educational Review*, 57, 1-22.
- Thompson, P. (2005). Personal communication.
- Vinner S. (1983). Concept Definition, concept image and the notion of function. *Int. Journal of Mathematical Education in Science and Technology*, 14, 293-305.
- Watson, A., & Mason, J. (in press). Seeing an Exercise as a Single Mathematical Object: Using Variation to Structure Sense-Making. *Mathematical Thinking and Learning*, 8(2) 91-111.
- Zaslavsky, O. & Lavie, O. (submitted). *What is entailed in choosing an instructional example?*
- Zaslavsky, O. & Peled, I. (1996). Inhibiting Factors in Generating Examples by Mathematics Teachers and Student-Teachers: The Case of Binary Operation. *Journal for Research in Mathematics Education (JRME)*, 27(1), 67-78.



# COGNITIVE CONFLICT AND ITS RESOLUTION VIA PIVOTAL/BRIDGING EXAMPLE

Rina Zazkis and Egan Chernoff

Simon Fraser University

*In this report we focus on one prospective elementary school teacher, Selina, and her attempt at one task, namely, to simplify  $\frac{13 \times 17}{19 \times 23}$ , in a clinical interview setting. We analyse her work considering prime numbers, divisibility and the fundamental theorem of arithmetic via theoretical constructs of cognitive conflict and its resolution. We introduce the notions of “pivotal example” and “bridging example” and discuss their role in building an analogy and in addressing and resolving a cognitive conflict.*

This report is a part of ongoing research on prospective teachers’ mathematical content knowledge. More specifically, we focus on how prospective teachers develop or change their understanding of number structure when presented with particular mathematical tasks. In this paper we focus on an excerpt from a clinical interview with one prospective elementary school teacher, Selina, and her attempt at one task, namely, to simplify  $\frac{13 \times 17}{19 \times 23}$ . We have chosen to analyse and present the excerpt from the interview with Selina because she was very explicit in sharing her ideas and way of thinking. We have chosen this particular task as it introduces minor novelty in a familiar setting and lets us follow Selina’s conflict in reconciling robust concepts with a novel realization.

## THE TASK

In choosing tasks to engage students in a clinical interview setting we focus on what Zazkis and Hazzan (1998) identified as “familiar with a twist”. The chosen task is familiar in a way that simplifying numerical expressions in general and reducing fractions in particular does not present novelty in the assignment. However, the twist is in the non-standard form the fraction is presented – both numerator and denominator being products of two primes. We were interested to see whether the students would notice that the numbers involved are prime and, in fact, there is no possibility to reduce the fraction. Therefore, considering prime decomposition, the fraction is already presented in its simplest form, or alternatively, the form achieved by multiplying the numbers in the numerator and the denominator,  $\frac{221}{437}$ , is the reduced simplified form.

## INTRODUCING SELINA

Selina is a prospective elementary school teacher in her late-twenties enrolled in a course “Principles of Mathematics for Teachers”, which is a core course in the

teacher certification program at the elementary level. During the course, and prior to the interview, the students studied a chapter on elementary number theory that included divisibility and divisibility rules, prime and composite numbers, factors and multiples, prime decomposition and the fundamental theorem of arithmetic. Selina's achievement in the course was above average, she had a positive attitude and willingness to engage with the subject matter, though she acknowledged not being exposed to any mathematical content since her high school graduation. Among the volunteers for the clinical interview she appeared as being able to articulate clearly her thinking about the problems and her solution approaches. Below we present a cognitive conflict that Selina faced and resolved during the interview.

## COGNITIVE CONFLICT

Studies of Piaget outlined the importance of the state of balance for cognitive growth, a balance that is achieved through accommodating/assimilating towards equilibration by meeting the challenges of disequilibrium. *Cognitive conflict* is an analogue of disequilibrium, referring to a pedagogical setting and a learner's cognitive development. A cognitive conflict is invoked when a learner is faced with contradiction or inconsistency in his or her ideas. It is important to mention that learners may possess conflicting ideas and co-existence of these ideas may not be acknowledged and thus will not create a dissonance. However, inconsistency of ideas presents a *potential conflict*, it will become a *cognitive conflict* only when explicitly invoked, usually in an instructional situation. With general acceptance of a variety of constructivists' perspectives, using cognitive conflict techniques has become a desirable pedagogical strategy to remedy misconceptions (Ernest, 1996). This approach allows students to trouble their own thinking, and it is through this conflict that they develop their own meanings, or at least seek to rectify the conflict. Implementing a cognitive conflict approach has been reported in studies on a variety of topics, such as division (Tirosh and Graeber, 1991), sampling and chance in statistics (Watson, 2002), limits (Tall, 1977) and infinity (Tsamir and Tirosh, 1999).

When errors occur, arising from some misconception, it is appropriate to expose the conflict and help the learner to achieve a resolution (Bell, 1993). However, while there is some understanding how a cognitive conflict can be exposed, once a potential conflict is recognised, there is little knowledge on how to help students in resolving the conflict. In this article we introduce the notion of "bridging/pivotal example" as a possible means towards conflict resolution.

## THE ROLE OF EXAMPLES

The central role of examples in teaching and learning mathematics has been long acknowledged. It is impossible to consider teaching and learning mathematics without consideration of specific examples. Examples are said to be an important component of expert knowledge. They are used to provide specific cases that fit the requirements of the definition under discussion, to verify statements and to illustrate algorithms and procedures (Rissland, 1991). Mason and Pimm (1984) suggest that

when a teacher presents an example, he or she sees its generality and relates to what the example represents. However, a learner may notice only particular features of a specific example, paying attention to the example itself and not to what it stands for. Therefore, Mason and Pimm advocate the use of so called ‘generic examples’, examples that represent the general case and attempt to ignore the specifics of the example itself.

An additional role of examples is in changing one’s mind or ways of operation. Examples that involve large numbers may help learners seek better approaches for a particular solution. Counterexamples may help learners’ readjust their perceptions or beliefs about the nature of mathematical objects. Further, the role of counterexamples has been acknowledged and discussed in creating a cognitive conflict (Klymchuk, 2001; Peled and Zaslavsky, 1997). However, counterexamples may not be sufficient in a conflict resolution. As teachers, we are to seek *strategic examples* that will serve as *pivotal examples* or *bridging examples* for the learner. *Pivotal examples* create a turning point in learner’s cognitive perception or in learner’s problem solving approaches; such examples may introduce a conflict or may resolve it. In other words, pivotal examples are examples that help learners in achieving what is referred to as ‘conceptual change’ (e.g. Tirosh and Tsamir, 2004). When a pivotal example assists in conflict resolution we refer to it as a *pivotal-bridging example*, or simply *bridging example*, that is, an example that serves as a bridge from learner’s naïve conceptions towards appropriate mathematical conceptions.

## SELINA’S APPROACH: AN ANALYSIS.

### Episode 1: Is 437 prime? Identifying potential conflict

Selina’s work on the task starts by multiplying out the numbers and then searching for common factors in the numerator and denominator.

Selina: So  $13 \times 17$  is 221, yeah okay, and then  $19 \times 23$ , um, (pause), I’m allowed to use the calculator.

Interviewer: Absolutely. . .

Selina: Okay, it’s 437. Okay, so we have  $221/437$ , neither of them are divisible by 2, neither of them are divisible by, well this, no it’s not divisible by 3 because this equals 5, um, and this equals 14, so I’ll try. . .

Interviewer: What do you mean equals 5, equals 14. . .

Selina: Well I’m checking for divisibility by 3, so I’m adding these three numbers, to see if it’s divisible by 3, um, so it’s not. . ., 221 divisible by 4, don’t think so, I’ll check, no it’s a decimal. Um, well see I think that, I think that 437 is a prime number, I have to see what 37 divided by 2 is, 18.5. I’m going to test it (pause), 437 divided by, let’s just say 7. . .

Interviewer: You said you are going to test it, what are you testing?

Selina: Oh I’m testing whether this number is prime or not, 437, whether it’s prime. . . So, um, just trial and error, I’m just going to try dividing it. . ., because it’s an odd number, I’m going to try dividing it by um certain

prime numbers that we know, like 13, that equals a decimal, divided by 17, that equals a decimal, um, divided by (pause) hmm, I don't know, (pause) I would say that's it, I don't know what else, how else to find, to find that.

Interviewer: So you started to check whether 437 was prime. . .

Selina: Um hm. . .

Interviewer: Is it?

Selina: I don't know, I'm getting lazy again. So it doesn't work for 13, it doesn't work for 17, let's try for 11, no, let's try, I tried it for 7 already, it's definitely not 5, it's definitely not 3, it's definitely not 2, um, (pause) well we know it divides, 19 divides 437 23 times because that's in the original equation. . .

Interviewer: So is it prime?

Selina: Yes it is, because it's two prime numbers, of course it is, because two prime numbers multiplied by each other are prime, (pause).

Selina immediately recognizes that 221 and 437 are not divisible by 2 and then proceeds to check divisibility by 3. It is interesting to note that after assuring that 437 is not divisible by 3 (using divisibility rules) and by 4 (using a calculator), she comes up with a conjecture that 437 is prime. Nevertheless, she keeps checking this numbers divisibility by 7, 13 and 17. Having tried 19 she confirms that "that's in the original equation", meaning that divisibility of 437 by 19 could be concluded from its being calculated as  $19 \times 23$ . At this moment she acknowledges for the first time her awareness that 19 and 23 are prime, but comes up with a conclusion that "two prime numbers multiplied by each other are prime". Such a derivation was acknowledged in prior research (Zazkis and Liljedahl, 2004) and was described as intuitive "tendency towards closure" that is, a tendency to view the result of an operation between two elements of a set as an element of the same set. However, Selina's explicit acknowledgement of this intuitive belief invited intervention. In what follows the interviewer attempts to invoke a cognitive conflict by presenting a strategic example.

## Episode 2: Strategic-pivotal example and invoking cognitive conflict

Interviewer: Is 15 a prime number?

Selina: No.

Interviewer: But it's two prime numbers multiplied by each other, 3 and 5. . .

Selina: But (pause) something about, 2 and 3 are tricky because they're, they're, I found that in my brain in looking up prime numbers 2 and 3 and 5, 15 isn't a prime number, yet it is the product of two prime numbers, but (pause) these numbers have a common factor of 1 and only 1, so (pause) I can't, I can't make into words what it is that I want to say. . .

Interviewer: Can you make me pictures (laugh). . .

Selina: Okay. 2 and 3, they're prime numbers, 19, 23, 13 and 17 are all prime numbers, um,  $2 \times 3 = 6$ , but 6 is not a prime number, so the theory that

any prime, (pause) so the theory that it's a closed set, it's not a closed set. So prime numbers under multiplication aren't necessarily a closed set, aren't a closed set, because there's the disproof of it. So . . .

Interviewer: In what way 19 multiplied by 23 is different from 2 multiplied by 3, and what I gave you before, 3 multiplied by 5? You claim 6 is not prime, you claim 15 is not prime, . . .

Selina: Um hm. . .

Interviewer: And still you suggested 437 is prime. So my question is, what is different?

Selina: Well you can, well that you can't divide it by 2, 3 or 5. . .

Interviewer: Yeah, but you can divide by 19. . .

Selina: (pause) I kind of see 2, 3 and 5 as building blocks to all other, uh other numbers, that's kind of the way I see it. And I find that once you can eliminate those as options, then you're dealing with, then you're dealing with prime numbers that, I (pause), I don't know how to say it, I don't know how to say it, it's frustrating (laugh).

The interviewer's strategic example is *pivotal* for Selina: she is faced with a conflict, and acknowledges her difficulty with frustration. Selina acknowledges that 15 and 6 are not prime numbers, even though they are products of two primes. So this disproves her initial suggestion that a product of primes is a prime, and she phrases it appropriately utilizing recently acquired terminology, "prime numbers under multiplication aren't a closed set". Following the request to describe in what way 2, 3 or 5 are different from 19 she alludes to her initial belief that a number 437 is prime because "you can't divide it by 2, 3 or 5". It was described in prior research that, in an attempt to check whether a given number is prime, students check the number's divisibility only by "small primes" (Zazkis & Liljedahl, 2004). The revealing point in Selina's description is that this way of thinking is explicitly acknowledged rather than derived from students' actions and that the list of "small primes" is limited to 2, 3 and 5. At this time the interview implies a technique described by Ginsburg (1997) as 'establishing the strength of belief', by introducing an additional strategic example.

### Episode 3: Strategic-bridging example and conflict resolution

Interviewer: Oh, I don't want to frustrate you, but it is very interesting what you're saying. How about 77?

Selina: 77 isn't prime because it's divisible by 11.

Interviewer: Oh I see, so is 11 one of your building blocks?

Selina: 11 is, (pause) I mean in this case 11 and 7 also factor out, also act the same way, oh no because, no I don't think 7 and 11 are building blocks that I'm talking about. I find 2, 3 and 5 are.

Interviewer: But is 77 prime?

Selina: No.

Interviewer: How about 221?

Selina: 221 I don't think is prime.

Interviewer: Why do you think these are not prime?

Selina: (pause) Well it can't (pause), no okay they're not prime, because they're not, they have more factors than just 1, right, so 437 can't be prime because its factor is 19 and 23. So prime meaning that it can only be multiplied the number by itself, right, so these aren't prime. The 437 isn't prime, (pause) so it changes everything.

Interviewer: What does it mean, it changes everything?

Selina: Well it changes what I first said, because I said that two numbers multiplied by each other, two prime numbers multiplied by each other would equal a prime number, but I was wrong in saying that, totally wrong.

We suggest that the interviewer's strategic choice of 77 serves as a *bridging* example for Selina in the resolution of the conflict. From a perspective of elementary number theory, the numbers mentioned in this interview excerpt – 6, 15, 77, 221 and 437 – are similar in their structure of prime decomposition. All these numbers are products of two prime numbers. So in what sense is 77 different from 6 and 15 on one hand and is different from 437 on the other hand? We suggest that on one hand this number is “small enough” so, similarly to 6 and 15, but unlike 437, its factors are immediately recognizable. On the other hand it is not composed of 2, 3 or 5, the numbers that Selina refers to as “building blocks”. As such, this number serves as a *pivotal-bridging example* for Selina as it “changes everything”, that is, changes her initial suggestion of a product of primes being a prime. We note that her earlier observation that “prime numbers under multiplication aren't *necessarily* a closed set” is based on considering a counterexample. She draws this conclusion most likely realising that a product of primes *may be* not a prime number. It is the example of 77 that “changes everything”, makes the initial assumption “totally wrong” for Selina and guides her towards a correct conclusion. Based on our interpretation of the language used by prospective elementary school teachers we suggest that “totally wrong” means here “wrong in all cases”, rather than wrong because of the existence of several counterexamples. At this stage Selina is referred to the initial problem of simplifying the given expression.

#### **Episode 4: Can you simplify? Potential conflict.**

Interviewer: So let's go back to our problem of simplifying this number, you perform multiplication in the numerator and the denominator to get this thing,  $221/437$ . The question is, can you simplify it?

Selina: No, because these four numbers are prime, you can't simplify because you would have to be, this number [pointing to 221] would have to be divisible by either of these two numbers [pointing to 19 and 23], and we'll test that. So 221 divided by 19 equals, so that is a decimal, so that doesn't work. 221 divided by 23 is also a decimal, so that doesn't work.

Here, on one hand, Selina claims that the fraction cannot be simplified, but on the other hand she finds it necessary to confirm with the help of a calculator that 221 is not divisible by either 19 or 23. She is probed further for her initial claim.

Interviewer: Is it possible to know that it will not work, what was just checked, without working with the calculator and without doing long division?

Selina: (pause) I'm sure there is a pattern somewhere, but I don't, I don't quite see it. [pause] Well you know what, see I'll see  $3 \times 7$  is 21 here and I see this  $9 \times 3$  is 7, which  $9 \times 3$  really is 27, so that might explain why this 7 is here, um, I'd go maybe look and that might be the direction that I would start looking in, these digits here, the 3, the 7, the 9 and the 3, I would look at that, just try and figure that out. But that's as far as I could go with it.

Is Selina applying, implicitly, the fundamental theory of arithmetic, in her claim that “because these four numbers are prime, you can't simplify”? The idea that prime decomposition is unique, as formalized by the fundamental theorem of arithmetic, was discussed and exemplified in class prior to the interviews. However, this idea is usually not accepted intuitively by students, especially when numbers larger than 10 are involved (Zazkis and Liljedahl, 2004). Being invited to explain why a product of 13 and 17 is not divisible by 19, Selina regresses to considering the last digits in multiplication, being “sure there is a pattern somewhere”. We recognise a potential conflict in Selina's awareness that the numbers are prime and yet her need to perform division to confirm lack of divisibility. However, this conflict was not invoked and resolved during the interview.

## DISCUSSION AND CONCLUSION

In this paper we introduced the notion of *pivotal example* that may also serve as a *bridging example* and illustrated how it helped in one learner's conceptual change. Selina's work on the presented task exhibits several popular misconceptions described in prior research (Zazkis and Liljedahl, 2004). Her initial suggestion that 437 could be a prime number is based on a belief that any composite number should be divisible by 2, 4 or 5. She further claims that 437 is prime as a product of two primes. Her desire to check divisibility of 437 by 13 and 17 is based in an implicit search for an “alternative” prime decomposition. Interviewer's strategic suggestion that 15 is also a product of two primes is a *pivotal example* for Selina. It invokes a conflict, but the similarity in the structure of 15 and 437 is rejected, noting pointing to 2,3 and 5 as “building blocks”, which makes them, in Selina's perception, different from other prime numbers. The strategic example of 77 helps Selina to reconsider her position. In such it serves as a *bridging example* (bridging between 15 and 437) and as a *pivotal example*, example that creates a conceptual change.

We note that the notion of bridging/pivotal example is learner-dependent, that is, a strategic example that is helpful for one learner may not be helpful to another. Further, in some cases a ‘critical mass’ of examples may be necessary to serve as a pivot or a bridge. While the conflict described in Episodes 1,2 and 3 is resolved, a potential conflict presented in Episode 4 is not invoked. It was the interviewer's

choice reading Selina's declining interest in the task not to press the issue any further at the given moment. However, how could it become a cognitive conflict? What strategic example can help Selina recognise the inefficiency of her approach of "checking divisibility"? What strategic examples can help Selina in achieving not only conceptual change in considering prime decomposition but also a procedural change, adjusting her reasoning and justification? Further research will address these important questions, providing a further contribution to the study of means for achieving a conceptual change in learning mathematics.

## References

- Bell, A. (1993). Principles for the design of teaching. *Educational Studies in Mathematics*, 24, 5-34.
- Ernest, P. (1996). Varieties of constructivism: A framework for comparison. In L.P. Steffe, P. Nesher, P. Cobb, G.A Goldin, and B. Greer (Eds.), *Theories of mathematical learning*. Nahwah, NJ: Lawrence Erlbaum.
- Ginsburg, Herbert P. (1997). *Entering the child's mind: The clinical interview in psychological research and practice*. Cambridge, UK: Cambridge University Press.
- Klymchuk, S. (2001). Counter examples and conflicts as a remedy to eliminate misconceptions and mistakes. *Proceedings of the 25<sup>th</sup> International Conference for Psychology in Mathematics Education*. Utrecht, The Netherlands. (1) 326.
- Mason, J., & Pimm, D. (1984). Generic examples: seeing the general in the particular. *Educational Studies in Mathematics*, 15, 227- 289.
- Peled, I., & Zaslavsky, O. (1997). Counter-example that (only) prove and Counter-example that (also) explain. *FOCUS on Learning Problems in mathematics*, 19(3), 49-61.
- Rissland, E. L. (1991). Example-based Reasoning. In J. F. Voss, D. N. Parkins, & J. W. Segal (Eds.), *Informal Reasoning in Education* (pp. 187-208). Hillsdale, NJ: Lawrence Erlbaum Associates.
- Tall, D. (1977). *Cognitive conflict and the learning of mathematics*. Paper presented at the First Conference of The International Group for the Psychology of Mathematics Education. Utrecht, Netherlands, Summer 1977.  
Available: [www.warwick.ac.uk/staff/David.Tall/pdfs/dot1977a-cog-confl-pme.pdf](http://www.warwick.ac.uk/staff/David.Tall/pdfs/dot1977a-cog-confl-pme.pdf)
- Tirosh, D., & Graeber, A. O. (1990). Evoking cognitive conflict to explore preservice teachers' thinking about division. *Journal for Research in Mathematics Education*, 21, (2), 98-108.
- Tirosh, D. & Tsamir, P. (2004). What can mathematics education gain from the conceptual change approach? And what can the conceptual change approach gain from its application to mathematics education? *Learning and Instruction*, 14(5), 535-540.
- Tsamir, P. & Tirosh, D. (1999) Consistency and representations: The case of actual infinity. *Journal for Research in Mathematics Education*, 30, 213-219.
- Watson, J.M. (2002). Inferential reasoning and the influence of cognitive conflict. *Educational Studies in Mathematics*, 51, 225-256.
- Zazkis, R. & Hazzan, O. (1998). Interviewing in mathematics education research: Choosing the questions. *Journal of Mathematical Behavior*, 17(4), 429-239.
- Zazkis, R. & Liljedahl, P. (2004). Understanding primes: The role of representation. *Journal for Research in Mathematics Education*, 35(3), 164-186.